

1. Package Contents

Thank you for purchasing PLANET Industrial IP67 1-port 10/100/1000T 802.3at PoE+ Injector, IPOE-165. In the following sections, the term "Outdoor PoE Injector" means the IPOE-165.

Open the box of the Industrial PoE Injector and carefully unpack it. The box should contain the following items:

IPOE-165 x 1	User's Manual x 1	Wall-mounted Kit x 1
		
		Spanner x 1
Power Cable with 2-pin Terminal Block x 1	M22 Waterproof Cable Gland x 3	
		Ground Wire x 1
		

If any of these are missing or damaged, please contact your dealer immediately; if possible, retain the carton including the original packing material, and use them again to repack the product in case there is a need to return it to us for repair.

- 1 -

2. Hardware Introduction

This section describes the functionalities of the outdoor PoE Injector's components.

2.1 Product Outlook

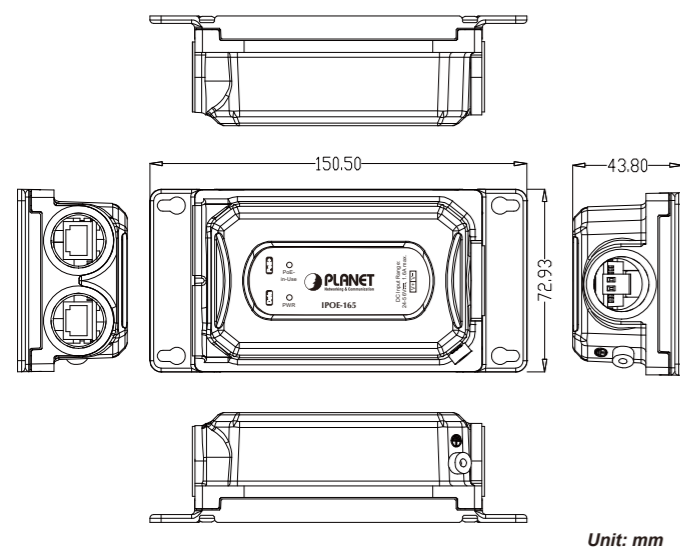

Figure 2-1: IPOE-165 product outlook

- 2 -

2.2 Power Input Port

Figure 2-2 shows the Power Input port side of the IPOE-165

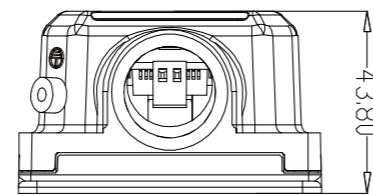

Figure 2-2: IPOE-165 Power Input port side

2.3 Data Input Port and 802.3at PoE+ Output Port

Figure 2-3 shows the Data Input Port and PoE+ Output Port side of the IPOE-165.

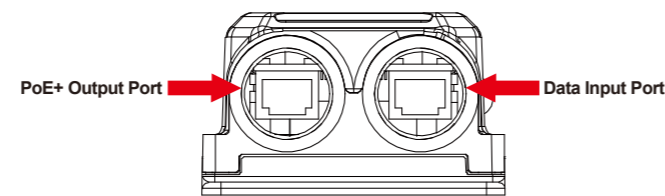

Figure 2-3: IPOE-165 two RJ45 ports side

- 3 -

2.4 LED Indicators

LED	Color	Function
PWR	Green	Indicates it has power.
PoE-in-Use	Green	Indicates the port is providing 54V DC in-line power.

To install the 2-pin Terminal Block Connector on the **Outdoor PoE Injector**, simply follow the following steps:

Step 1: Insert positive DC power wire into V+, negative DC power wire into V-, and grounding wire into **Ground**.

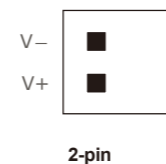

Step 2: Tighten the wire-clamp screws for preventing the wires from loosening and plug them into the PoE Injector.

- Note
- The wire gauge should be in the range from 20 to 22 AWG.
 - The device must be grounded.

- 4 -

3. Installation

This section describes how to install the Outdoor PoE Injector and make connections to it. Please read the following topics and perform the procedure in the order being presented.

3.1 Installing Cable Gland with Power Cable and RJ45 UTP Cable

The cable gland consists of the following:

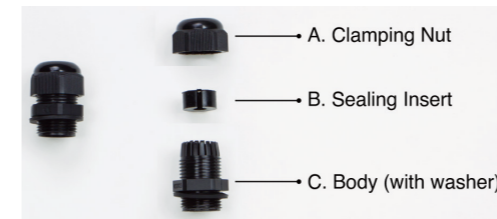

3.2 Connecting Waterproof Cable Kit to the Outdoor PoE Injector

Step 1: Turn clockwise to tighten the **gland body** connected to the Outdoor PoE Injector.



- 5 -

Step 2: Plug the power cable connector into the power input port.

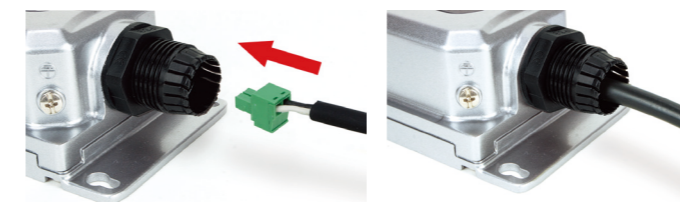

Step 3: Insert the **sealing insert** into the cable gland body.

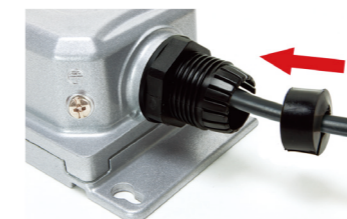

Step 4: Attach the **clamping nut** to the cable gland to complete the cable assembly.

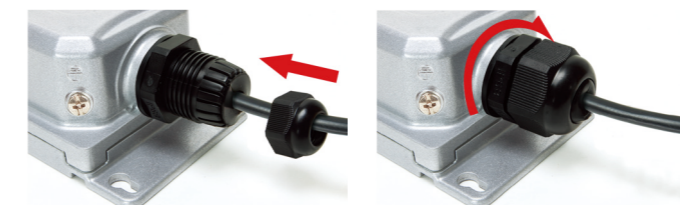

- 6 -



Make sure the clamping nut is tightly attached to the cable gland body and the sealing insert is squeezed tightly.

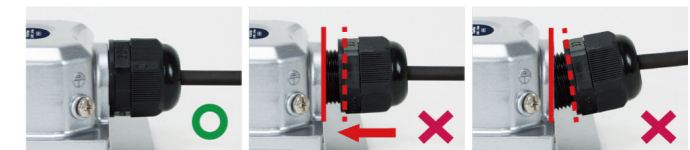

Step 5: Repeat **Steps 1 to 4** for "Data" Input Port and "PoE (Data + Power)" Output Port

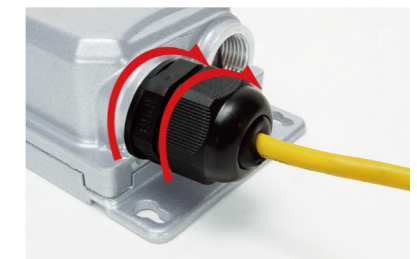

- 7 -

Note

- Use only the waterproof cable gland provided in the package of the IPOE-165.
- If the above installation procedure is not properly followed, the warranty will be invalidated.

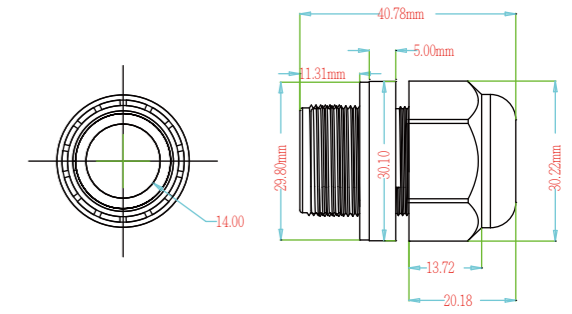

- If the waterproof cable gland is found missing or damage, please contact your local reseller where you purchased from.
- Never use any waterproof cable gland that is not purchased from PLANET or doesn't have the same dimensions of the IPOE-165; it will damage the device permanently.

3.3 Wall-mount Installation

To install the Outdoor PoE Injector on the wall, please follow the instructions described below.

Step 1: Find the wall that you want to mount the Outdoor PoE Injector on.

- 8 -

Step 2: Refer to the picture below to screw the four screws on the wall.

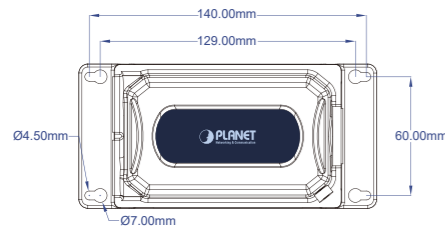

Step 3: Use a screwdriver to screw them into the wall.



3.4 Grounding the Device

Users **MUST** complete grounding wired with the device; otherwise, a sudden lightning could cause fatal damage to the device.

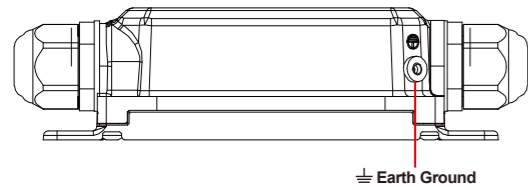

4. Product Specifications

Product	IPOE-165		
Hardware Specifications			
Interface	Input Port	1 x 10/100/1000BASE-T "Data" in RJ45 port	
	Output Port	1 x 10/100/1000BASE-T Ethernet with IEEE 802.3at PoE+ "Data + DC" out RJ45 port	
	Input Power Terminal Block	1 x 2-pin terminal block - Pin 1/2 for Power (Pin 1: V+ / Pin 2: V-)	
Network Cable	10BASE-T: UTP category 3, 5 cable (≤100m) 100BASE-TX: UTP category 5,5e cable (≤100m) 1000BASE-T: UTP category 5e,6 cable(≤100m)		
Data Rate	10/100/1000Mbps		
LED Indicator	PWR (Green) PoE-in-use x 1 (Green)		
Input Voltage	24~56V DC		
Power Consumption	Voltage	System on	Full Load (Max.)
	DC 24V	0.72W	43.4W
	DC 36V	0.72W	41.04W
	DC 54V	1.08W	40.5W

www.PLANET.com.tw

Industrial IP67 1-Port 802.3at PoE+ Injector

IPOE-165



PLANET Technology Corp.
10F., No. 96, Minquan Rd., Xindian Dist., New Taipei City 231, Taiwan

Warning:
This device is compliant with Class A of CISPR 32.
In a residential environment this device may cause radio interference.
2351-AH8080-002



EMD (Lightning) DAMAGE IS NOT COVERED UNDER WARRANTY.

3.5 Connecting IPOE-165 to PD

Step 1: Connect the additional Cat5e/6 cable from the **PoE+ Out** of the IPOE-165 to a remote **PD**.

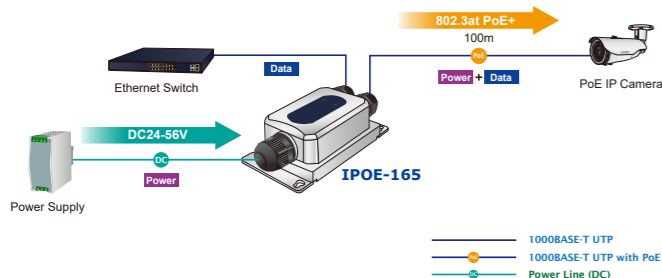

Step 2: The **PoE+ Out** port is the power injector which transmits DC voltage to the Cat5e/6 cable and transfer data from the Data source.

Step 3: Once the IPOE-165 detects the existence of an IEEE 802.3at/af device or Ethernet device, the **LAN** LED indicator will be lit steadily, showing it is providing power.



According to IEEE 802.3at/af standard, the IPOE-165 will not inject power to the cable if not connected to a standard IEEE 802.3at/af device.

ESD Protection	Air 8KV DC Contact 6KV DC
Surge Protection	6KV
Enclosure	IP67-rated and IK10 aluminum metal case
Installation	Wall-mount ear
Dimensions (W x D x H)	150 x 43.8 x 72.94 mm 169.85 x 43.8 x 72.94 mm, with cable gland
Weight	339g 373g (with three waterproof cable glands)
MTBF	>100000 hours
Power over Ethernet	
PoE Standard	IEEE 802.3at Power over Ethernet Plus/ End-span PSE Backward compatible with IEEE 802.3af Power over Ethernet
PoE Power Output	54V DC, max. 30 watts
PoE Power Supply Type	End-span
Power Pin Assignment	1/2 (+), 3/6 (-)

Standards Conformance	
Regulatory Compliance	FCC Part 15 Class A CE
Stability Testing	IEC 60068-2-32 (Free fall) IEC 60068-2-27 (Shock) IEC 60068-2-6 (Vibration)
Standards Conformances	IEEE 802.3 10BASE-T Ethernet IEEE 802.3u 100BASE-TX Fast Ethernet IEEE 802.3ab 1000BASE-T Gigabit Ethernet IEEE 802.3af Power over Ethernet IEEE 802.3at Power over Ethernet Plus
Environment	
Operating Temperature	-40 ~ 75 degrees C
Storage Temperature	-40 ~ 85 degrees C
Humidity	5 ~ 95% (non-condensing)



The PoE power output ability will depend on the distance.

5. Customer Support

Thank you for purchasing PLANET products. You can browse our online FAQ resource and user's manual on PLANET web site first to check if it could solve your issue. If you need more support information, please contact PLANET support team.

PLANET online FAQs:
<https://www.planet.com.tw/en/support/faq?method=category&c1=2>

Support team mail address:
support@planet.com.tw