

User's Manual



L2/L4 Long Reach PoE Managed Switch

- ▶ LRP-822CS
- ▶ LRP-1622CS



Trademarks

Copyright © PLANET Technology Corp. 2015.

Contents are subject to revision without prior notice.

PLANET is a registered trademark of PLANET Technology Corp. All other trademarks belong to their respective owners.

Disclaimer

PLANET Technology does not warrant that the hardware will work properly in all environments and applications, and makes no warranty and representation, either implied or expressed, with respect to the quality, performance, merchantability, or fitness for a particular purpose. PLANET has made every effort to ensure that this User's Manual is accurate; PLANET disclaims liability for any inaccuracies or omissions that may have occurred.

Information in this User's Manual is subject to change without notice and does not represent a commitment on the part of PLANET. PLANET assumes no responsibility for any inaccuracies that may be contained in this User's Manual. PLANET makes no commitment to update or keep current the information in this User's Manual, and reserves the right to make improvements to this User's Manual and/or to the products described in this User's Manual, at any time without notice.

If you find information in this manual that is incorrect, misleading, or incomplete, we would appreciate your comments and suggestions.

FCC Warning

This equipment has been tested and found to comply with the limits for a Class A digital device, pursuant to Part 15 of the FCC Rules. These limits are designed to provide reasonable protection against harmful interference when the equipment is operated in a commercial environment. This equipment generates, uses, and can radiate radio frequency energy and, if not installed and used in accordance with the Instruction manual, may cause harmful interference to radio communications. Operation of this equipment in a residential area is likely to cause harmful interference in which case the user will be required to correct the interference at his own expense.

CE Mark Warning

This is a Class A product. In a domestic environment, this product may cause radio interference, in which case the user may be required to take adequate measures.

Energy Saving Note of the Device

This power required device does not support Standby mode operation. For energy saving, please remove the power cable to disconnect the device from the power circuit. In view of saving the energy and reducing the unnecessary power consumption, it is strongly suggested to remove the power connection for the device if this device is not intended to be active.

WEEE Warning



To avoid the potential effects on the environment and human health as a result of the presence of hazardous substances in electrical and electronic equipment, end users of electrical and electronic equipment should understand the meaning of the crossed-out wheeled bin symbol. Do not dispose of WEEE as unsorted municipal waste and have to collect such WEEE separately.

Revision

PLANET Multi-port Coax + 2-port 10/100/1000T + 2-port 100/1000X SFP Long Reach PoE over Coaxial Switch User's Manual
For Model: LRP-822CS/LRP-1622CS

Revision: 1.1 (Jul. 2015)

Part No: EM-LRP-822CS_LRP-1622CS_v1.1

TABLE OF CONTENTS

| | |
|--|-----------|
| 1. INTRODUCTION..... | 10 |
| 1.1 Packet Contents | 10 |
| 1.2 Product Description | 11 |
| 1.3 How to Use This Manual | 16 |
| 1.4 Product Features | 16 |
| 1.5 Product Specifications | 19 |
| 2. INSTALLATION | 23 |
| 2.1 Hardware Description | 23 |
| 2.1.1 Switch Front Panel | 23 |
| 2.1.2 LED Indications | 25 |
| 2.1.3 Switch Rear Panel | 27 |
| 2.2 Installing the Switch..... | 28 |
| 2.2.1 Desktop Installation | 28 |
| 2.2.2 Rack Mounting..... | 29 |
| 2.2.3 Installing the SFP transceiver | 30 |
| 2.2.4 Installing the Long Reach PoE Communication..... | 33 |
| 3. SWITCH MANAGEMENT | 37 |
| 3.1 Requirements..... | 37 |
| 3.2 Management Access Overview | 38 |
| 3.3 Administration Console | 39 |
| 3.4 Web Management | 40 |
| 3.5 SNMP-based Network Management | 41 |
| 3.6 PLANET Smart Discovery Utility | 41 |
| 4. WEB CONFIGURATION..... | 43 |
| 4.1 Main Web Page | 46 |
| 4.1.1 Save Button | 47 |
| 4.1.2 Configuration Manager | 48 |
| 4.1.2.1 Saving Configuration | 49 |

| | |
|---|-----------|
| 4.2 System | 50 |
| 4.2.1 System Information..... | 50 |
| 4.2.2 IP Configurations | 51 |
| 4.2.3 IPv6 Configuration | 53 |
| 4.2.4 User Configuration..... | 55 |
| 4.2.5 Time Settings..... | 56 |
| 4.2.5.1 System Time..... | 56 |
| 4.2.5.2 SNTP Server Settings | 59 |
| 4.2.6 Log Management..... | 60 |
| 4.2.6.1 Local Log..... | 60 |
| 4.2.6.2 Local Log..... | 61 |
| 4.2.6.3 Remote Syslog | 63 |
| 4.2.6.4 Log Message..... | 64 |
| 4.2.7 SNMP Management | 67 |
| 4.2.7.1 SNMP Overview | 67 |
| 4.2.7.2 SNMP System Information | 68 |
| 4.2.7.3 SNMP View | 69 |
| 4.2.7.4 SNMP Access Group..... | 71 |
| 4.2.7.5 SNMP Community | 72 |
| 4.2.7.6 SNMP User..... | 74 |
| 4.2.7.7 SNMPv1, 2 Notification Recipients | 75 |
| 4.2.7.9 SNMPv3 Notification Recipients | 77 |
| 4.2.7.10 SNMP Engine ID | 78 |
| 4.2.7.11 SNMP Remote Engine ID | 79 |
| 4.3 Port Management | 80 |
| 4.3.1 Port Configuration..... | 80 |
| 4.3.2 LRP Port Configuration..... | 82 |
| 4.3.3 Port Counters | 84 |
| 4.3.4 Bandwidth Utilization | 89 |
| 4.3.5 Port Mirroring..... | 90 |
| 4.3.6 Jumbo Frame | 92 |
| 4.3.7 Port Error Disabled Configuration..... | 93 |
| 4.3.8 Port Error Disabled | 95 |
| 4.3.9 Protected Ports..... | 95 |
| 4.3.10 EEE | 98 |
| 4.3.11 SFP Module Information | 99 |
| 4.3.11.1 SFP Module Status | 99 |
| 4.3.11.1 SFP Module Detail Status | 101 |

| | |
|--|------------|
| 4.4 Link Aggregation | 102 |
| 4.4.1 LAG Setting | 104 |
| 4.4.2 LAG Management | 105 |
| 4.4.3 LAG Port Setting..... | 106 |
| 4.4.4 LACP Setting..... | 108 |
| 4.4.5 LACP Port Setting..... | 109 |
| 4.4.6 LAG Status | 110 |
| 4.5 VLAN..... | 113 |
| 4.5.1 VLAN Overview | 113 |
| 4.5.2 IEEE 802.1Q VLAN | 114 |
| 4.5.3 Management VLAN | 117 |
| 4.5.4 Create VLAN | 118 |
| 4.5.5 Interface Settings..... | 119 |
| 4.5.6 Port to VLAN..... | 124 |
| 4.5.7 Port VLAN Membership..... | 125 |
| 4.5.8 Protocol VLAN Group Setting | 126 |
| 4.5.9 Protocol VLAN Port Setting | 127 |
| 4.5.10 GVRP Setting | 129 |
| 4.5.11 GVRP Port Setting | 131 |
| 4.5.12 GVRP VLAN..... | 133 |
| 4.5.13 GVRP Statistics | 133 |
| 4.5.14 VLAN Setting Example: | 135 |
| 4.5.14.1 Two Separate 802.1Q VLANs..... | 135 |
| 4.5.14.2 VLAN Trunking between Two 802.1Q Aware Switches | 138 |
| 4.6 Spanning Tree Protocol | 141 |
| 4.6.1 Theory | 141 |
| 4.6.2 STP Global Settings | 147 |
| 4.6.3 STP Port Setting..... | 149 |
| 4.6.4 CIST Instance Setting..... | 152 |
| 4.6.5 CIST Port Setting..... | 154 |
| 4.6.6 MST Instance Configuration | 156 |
| 4.6.7 MST Port Setting | 159 |
| 4.6.8 STP Statistics | 161 |
| 4.7 Multicast..... | 162 |
| 4.7.1 Properties | 162 |
| 4.7.2 IGMP Snooping | 164 |
| 4.7.2.1 IGMP Setting | 168 |
| 4.7.2.2 IGMP Querier Setting | 170 |

| | |
|--|------------|
| 4.7.2.3 IGMP Static Group | 171 |
| 4.7.2.4 IGMP Group Table | 172 |
| 4.7.2.5 IGMP Router Setting | 173 |
| 4.7.2.6 IGMP Router Table | 174 |
| 4.7.2.7 IGMP Forward All | 175 |
| 4.7.3 IGMP Snooping Statics | 176 |
| 4.7.4 MLD Snooping | 178 |
| 4.7.4.1 MLD Setting | 178 |
| 4.7.4.2 MLD Static Group | 180 |
| 4.7.4.3 MLD Group Table | 181 |
| 4.7.4.4 MLD Router Setting | 181 |
| 4.7.4.5 MLD Router Table | 183 |
| 4.7.4.6 MLD Forward All | 184 |
| 4.7.5 MLD Snooping Statics | 185 |
| 4.7.6 Multicast Throttling Setting | 187 |
| 4.7.7 Multicast Filter | 188 |
| 4.7.7.1 Multicast Profile Setting | 189 |
| 4.7.7.2 IGMP Filter Setting | 190 |
| 4.7.7.3 MLD Filter Setting | 191 |
| 4.8 Quality of Service | 193 |
| 4.8.1 Understand QoS | 193 |
| 4.8.2 General | 194 |
| 4.8.2.1 QoS Properties | 194 |
| 4.8.2.2 QoS Port Settings | 195 |
| 4.8.2.3 Queue Settings | 196 |
| 4.8.2.4 CoS Mapping | 197 |
| 4.8.2.5 DSCP Mapping | 199 |
| 4.8.2.6 IP Precedence Mapping | 201 |
| 4.8.3 QoS Basic Mode | 202 |
| 4.8.3.1 Global Settings | 202 |
| 4.8.3.2 Port Settings | 203 |
| 4.8.4 Rate Limit | 204 |
| 4.8.4.1 Ingress Bandwidth Control | 204 |
| 4.8.4.2 Egress Bandwidth Control | 206 |
| 4.8.4.3 Egress Queue | 207 |
| 4.8.5 Voice VLAN | 209 |
| 4.8.5.1 Introduction to Voice VLAN | 209 |
| 4.8.5.2 Properties | 209 |
| 4.8.5.3 Telephony OUI MAC Setting | 211 |

| | |
|---|------------|
| 4.8.5.4 Telephony OUI Port Setting | 213 |
| 4.9 Security | 215 |
| 4.9.1 802.1X | 215 |
| 4.9.1.1 Understanding IEEE 802.1X Port-based Authentication | 216 |
| 4.9.1.2 802.1X Setting | 219 |
| 4.9.1.3 802.1X Port Setting | 220 |
| 4.9.1.4 Guest VLAN Setting | 222 |
| 4.9.1.5 Authenticated Host | 225 |
| 4.9.2 RADIUS Server | 225 |
| 4.9.3 TACACS+ Server | 228 |
| 4.9.4 AAA | 231 |
| 4.9.4.1 Login List | 232 |
| 4.9.4.2 Enable List | 233 |
| 4.9.5 Access | 234 |
| 4.9.5.1 Telnet | 234 |
| 4.9.5.2 SSH | 235 |
| 4.9.5.3 HTTP | 237 |
| 4.9.5.4 HTTPs | 239 |
| 4.9.6 Management Access Method | 240 |
| 4.9.6.1 Profile Rules | 240 |
| 4.9.6.2 Access Rules | 241 |
| 4.9.7 DHCP Snooping | 243 |
| 4.9.7.1 DHCP Snooping Overview | 243 |
| 4.9.7.2 Global Setting | 244 |
| 4.9.7.3 VLAN Setting | 245 |
| 4.9.7.4 Port Setting | 247 |
| 4.9.7.5 Statistics | 248 |
| 4.9.7.6 Database Agent | 249 |
| 4.9.7.7 Rate Limit | 251 |
| 4.9.7.8 Option 82 Global Setting | 253 |
| 4.9.7.9 Option 82 Port Setting | 254 |
| 4.9.7.10 Option 82 Circuit-ID Setting | 256 |
| 4.9.8 Dynamic ARP Inspection | 257 |
| 4.9.8.1 Global Setting | 257 |
| 4.9.8.2 VLAN Setting | 258 |
| 4.9.8.3 Port Setting | 259 |
| 4.9.8.4 Statistics | 261 |
| 4.9.8.5 Rate Limit | 262 |
| 4.9.9 IP Source Guard | 263 |

| | |
|--|------------|
| 4.9.9.1 Port Settings | 264 |
| 4.9.9.2 Binding Table | 265 |
| 4.9.10 Port Security | 267 |
| 4.9.11 DoS | 269 |
| 4.9.11.1 Global DoS Setting | 269 |
| 4.9.11.2 DoS Port Setting | 272 |
| 4.9.12 Storm Control | 274 |
| 4.9.12.1 Global Setting | 274 |
| 4.9.12.2 Port Setting | 275 |
| 4.10 ACL | 277 |
| 4.10.1 MAC-based ACL | 277 |
| 4.10.2 MAC-based ACE | 278 |
| 4.10.3 IPv4-based ACL | 281 |
| 4.10.4 IPv4-based ACE | 281 |
| 4.10.5 IPv6-based ACL | 287 |
| 4.10.6 IPv6-based ACE | 287 |
| 4.10.7 ACL Binding | 293 |
| 4.11 MAC Address Table | 294 |
| 4.11.1 Static MAC Setting | 294 |
| 4.11.2 MAC Filtering | 295 |
| 4.11.3 Dynamic Address Setting | 296 |
| 4.11.4 Dynamically Learned | 297 |
| 4.12 LLDP | 299 |
| 4.12.1 Link Layer Discovery Protocol | 299 |
| 4.12.2 LLDP Global Setting | 299 |
| 4.12.3 LLDP Port Setting | 302 |
| 4.12.4 LLDP Local Device | 305 |
| 4.12.5 LLDP Remote Device | 306 |
| 4.12.6 MED Network Policy | 308 |
| 4.12.7 MED Port Setting | 311 |
| 4.12.8 LLDP Overloading | 314 |
| 4.12.9 LLDP Statistics | 315 |
| 4.13 Diagnostics | 317 |
| 4.13.1 Cable Diagnostics | 317 |
| 4.13.2 Ping | 319 |
| 4.13.3 Ping Test | 319 |
| 4.13.4 IPv6 Ping Test | 320 |

| | |
|---|------------|
| 4.14 RMON..... | 321 |
| 4.14.1 RMON Statistics | 321 |
| 4.14.2 RMON Event | 323 |
| 4.14.3 RMON Event Log | 324 |
| 4.14.4 RMON Alarm | 325 |
| 4.14.5 RMON History | 328 |
| 4.14.6 RMON History Log | 329 |
| 4.15 Power over Ethernet | 330 |
| 4.15.1 Long Reach Power over Ethernet Powered Device..... | 331 |
| 4.15.2 System Configuration | 332 |
| 4.15.3 Power over Ethernet Configuration..... | 332 |
| 4.15.4 PoE Schedule..... | 335 |
| 4.15.5 PoE Alive Check Configuration..... | 338 |
| 4.16 Maintenance..... | 340 |
| 4.16.1 Factory Default | 340 |
| 4.16.2 Reboot Switch | 341 |
| 4.16.3 Backup Manager | 341 |
| 4.16.4 Upgrade Manager..... | 342 |
| 4.16.5 Dual Image | 343 |
| 5. SWITCH OPERATION | 344 |
| 5.1 Address Table..... | 344 |
| 5.2 Learning | 344 |
| 5.3 Forwarding & Filtering | 344 |
| 5.4 Store-and-Forward | 344 |
| 5.5 Auto-Negotiation | 345 |
| 6. TROUBLESHOOTING..... | 346 |
| APPENDIX A | 348 |
| A.1 Switch's RJ45 Pin Assignments..... | 348 |
| A.2 10/100Mbps, 10/100BASE-TX..... | 348 |

1. INTRODUCTION

Thank you for purchasing PLANET LRP Managed Switch series, which comes with multiple Long Reach PoE female BNC, Gigabit Ethernet copper and SFP fiber optic connectivity, and robust layer 2 and layer 4 features. The description of this model is shown below:

LRP-822CS 8-port Coax + 2-port 10/100/1000T + 2-port 100/1000X SFP Long Reach PoE over Coaxial Managed Switch

LRP-1622CS 16-port Coax + 2-port 10/100/1000T + 2-port 100/1000X SFP Long Reach PoE over Coaxial Managed Switch

“LRP Managed Switch” is used as an alternative name in this user’s manual.

1.1 Packet Contents

Open the box of the LRP Managed Switch and carefully unpack it. The box should contain the following items:

- ◆ The LRP Managed Switch x 1
- ◆ Quick Installation Guide x 1
- ◆ Rubber Feet x 4
- ◆ Power Cord x 1
- ◆ RS232 to RJ45 Console Cable x 1
- ◆ SFP Dust Cap x 2
- ◆ BNC Female Dust Cap x 8 (LRP-822CS)
- ◆ BNC Female Dust Cap x 16 (LRP-1622CS)
- ◆ Warning Sticker x 8 (LRP-822CS)
- ◆ Warning Sticker x 16 (LRP-1622CS)
- ◆ Rack-mount Accessory Kit x 1

If any item is found missing or damaged, please contact your local reseller for replacement.

1.2 Product Description

PLANET **Long Reach PoE Solution** enables all enterprises and network service providers to set up an IP infrastructure in a remote location where 802.3af/at PoE compliant powered devices can receive both data and power via PLANET switches, and PLANET LRP extenders and injectors over a long distance but not limited to the normal 100 meters.

Intelligent Long Reach PoE Switch on Coaxial-based Network

PLANET LRP Managed Switch series, a brand-new Multi-channel Long Reach PoE Switch, features an extended Ethernet and PoE networking of up to 1,000 meters over the existing coaxial cables going to multiple PoE IP cameras. It provides IPv6 / IPv4 dual stack management and built-in L2/L4 Gigabit Switching engine along with **multi-BNC ports** with Long Reach PoE Injector function, **2 Gigabit copper ports** and **2 extra 100/1000BASE-X SFP fiber slots**. As an advanced PoE switch, the PLANET LRP Managed Switch features **intelligent PoE** functions to improve the availability of critical applications. It provides a quick, safe and cost-effective PoE network solution to upgrading the existing coaxial cable infrastructure from the analog system to the HD IP surveillance system.

Multi-channel Long Reach Power over Ethernet

To support the enterprises in easily building a multi-channel and centrally-controlled Long Reach PoE system, the LRP-822CS works with the Long Reach PoE Extenders, LRP-101CE, via its **BNC ports** being the Long Reach PoE injectors for all connected LRP Extenders. Each of the BNC port features long range data and power transmission for distance up to **1,000m (3,280ft)** over **coaxial cable** to the LRP Extender, and another **100m** over **Ethernet cable** to remote PoE IP camera, PoE wireless AP or access control systems complied with **802.3af/at PoE**.

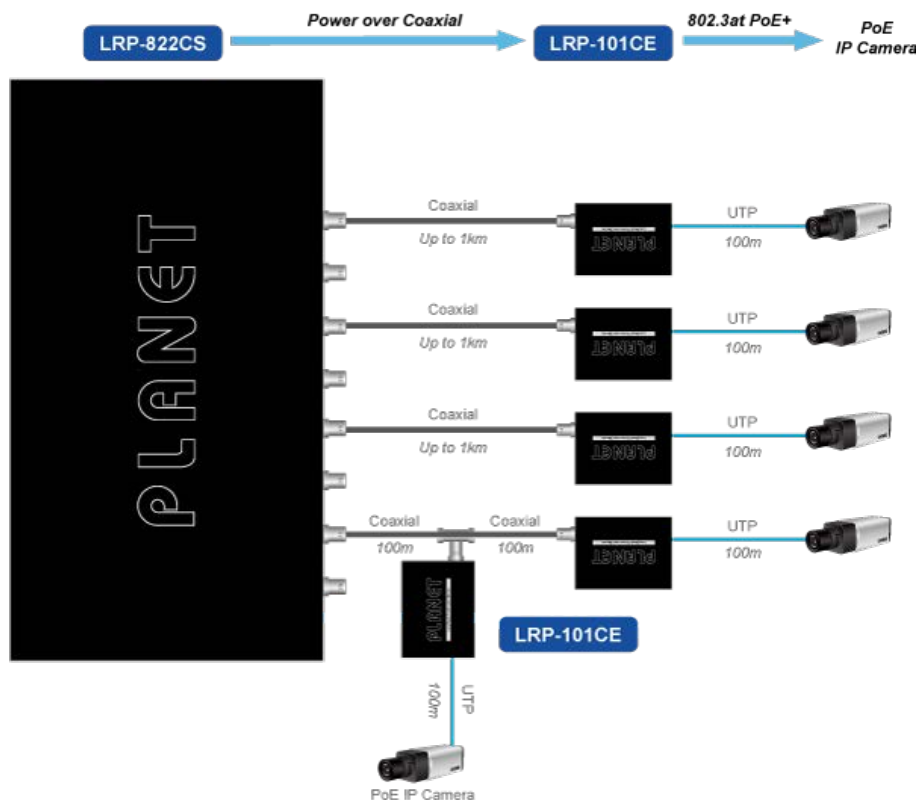

Centralized Power Management

PLANET LRP Managed Switch eliminates the need for an additional remote site power while allowing a single power source to provide power to both LRP extenders and the PoE powered devices at long range. The Long Reach PoE capabilities provided help to reduce installation time and deployment costs for network devices as a result of freeing from restrictions of power outlet locations.

Daisy-chaining Multiple Nodes

PLANET Long Reach PoE solution can easily build a power system for centrally-controlled IP cameras in a high availability network infrastructure. It gives users the flexibility to expand small area network with **BNC T-connector** for sharing **four nodes** per port when needed.

Built-in Unique PoE Functions for Powered Devices Management

As a managed PoE switch for surveillance, wireless and VoIP networks, the PLANET LRP Managed Switch particularly features the following special PoE Management functions to accomplish a highly-efficient Long Reach network:

- PD Alive Check
- Scheduled Power Recycling
- PoE Schedule
- PoE Usage Monitoring

Intelligent Powered Device Alive Check

The PLANET LRP Managed Switch can be configured to monitor connected PD (Powered Device) status in real time via ping action. Once the PD stops working and responding, the PLANET LRP Managed Switch will resume the PoE port power and bring the PD back to work. It will greatly enhance the network reliability through the PoE port resetting the PD's power source and reducing administrator management burden.

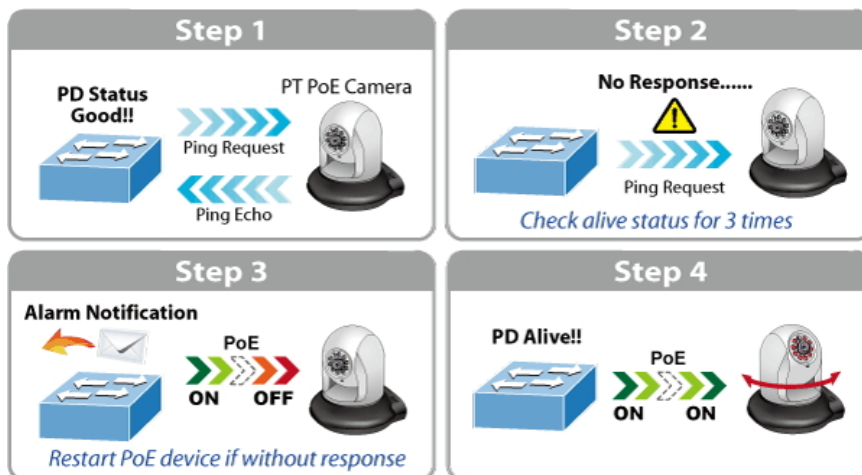

Scheduled Power Recycling

PLANET LRP Managed Switch allows each of the connected PoE IP cameras or PoE wireless access points via the LRP-101CE to reboot at a specific time each week. Therefore, it will reduce the chance of IP camera or wireless AP crash resulting from buffer overflow.

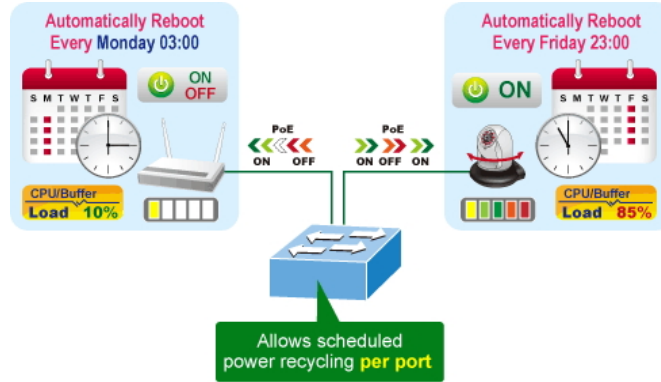

PoE Schedule for Energy Saving

Under the trend of energy saving worldwide and contributing to environmental protection, the PLANET LRP Managed Switch can effectively control the power supply besides its capability of giving high watts power. The “PoE schedule” function helps you to enable or disable PoE power feeding for each PoE port during specified time intervals and it is a powerful function to help SMBs or enterprises save power and money. It also increases security by powering off PDs that should not be in use during non-business hours.

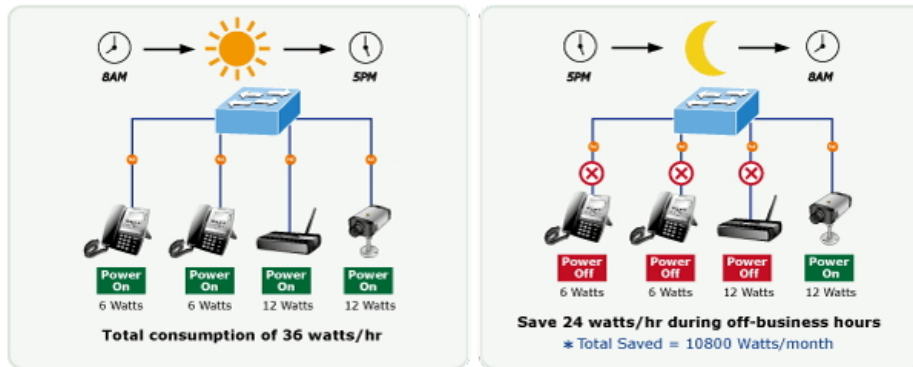

PoE Usage Monitoring

Via the power usage chart in the web management interface, PLANET LRP Managed Switch enables the administrator to monitor the status of the power usage of the connected PDs in real time. Thus, it greatly enhances the management efficiency of the facilities.

PoE Over-temperature Protection System

The **over-temperature protection** of PLANET LRP Managed Switch offers a safe and stable PoE operation by limiting the output power in order to avoid destructive breakdown due to unexpected overheating.

Environment-friendly, Smart Fan Design for Silent Operation

PLANET LRP Managed Switch features a 19-inch metal housing, a low noise design and an effective ventilation system. It supports the smart fan technology to automatically control the speed of the built-in fan to reduce noise and maintain the temperature of the PoE switch for optimal power output capability. PLANET LRP Managed Switch is able to operate reliably, stably and quietly in any environment without affecting its performance.

IPv6 / IPv4 Dual Stack

Supporting both IPv6 and IPv4 protocols, PLANET LRP Managed Switch enables SMBs to step in the IPv6 era with the lowest investment as its network facilities need not be replaced or overhauled if the IPv6 FTTx edge network is set up.

Robust Layer 2 Features

PLANET LRP Managed Switch can be programmed for advanced switch management functions such as dynamic port link aggregation, 802.1Q VLAN and **Q-in-Q VLAN**, **Multiple Spanning Tree Protocol (MSTP)**, Loop and **BPDU Guard**, **IGMP Snooping**, and **MLD Snooping**. Via the link aggregation, PLANET LRP Managed Switch allows the operation of a high-speed trunk to combine with multiple ports such as an 8Gbps fat pipe, and supports fail-over as well. Also, the Link Layer Discovery Protocol (LLDP) is the Layer 2 Protocol included to help discover basic information about neighboring devices on the local broadcast domain.

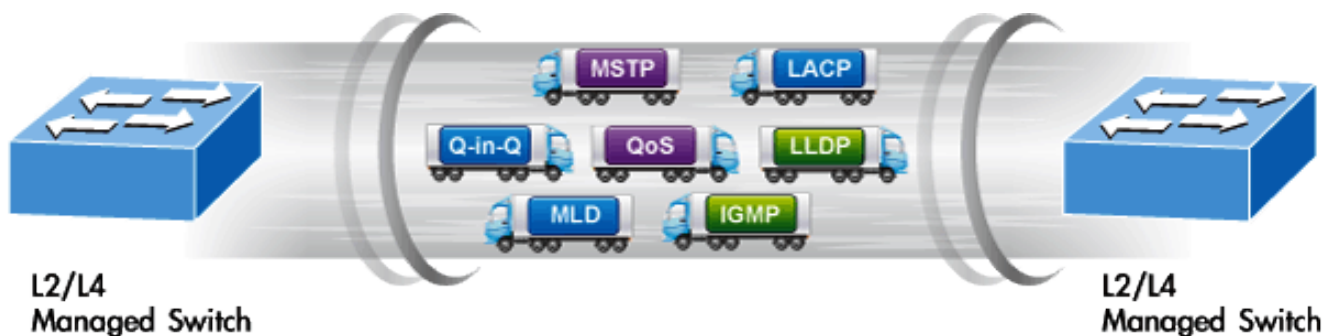

Efficient Traffic Control

PLANET LRP Managed Switch is loaded with robust QoS features and powerful traffic management to enhance services to business-class data, voice, and video solutions. The functionality includes broadcast/multicast **storm control**, per port **bandwidth control**, IP DSCP QoS priority and remarking. It guarantees the best performance for VoIP and video stream transmission, and empowers the enterprises to take full advantage of the limited network resources.

Powerful Security

PLANET LRP Managed Switch offers comprehensive **IPv4 / IPv6** Layer 2 to Layer 4 **Access Control List (ACL)** for enforcing security to the edge. It can be used to restrict network access by denying packets based on source and destination IP address, TCP/UDP ports or defined typical network applications. Its protection mechanism also comprises **802.1X port-based** user and device authentication, which can be deployed with RADIUS to ensure the port level security and block illegal users. With the **Protected Port** function, communication between edge ports can be prevented to guarantee user privacy. Furthermore, **Port Security** function allows to limit the number of network devices on a given port.

Advanced Network Security

PLANET LRP Managed Switch also provides **DHCP Snooping**, **IP Source Guard** and **Dynamic ARP Inspection** functions to prevent IP snooping from attack and discard ARP packets with invalid MAC address. The network administrators can now build highly-secured corporate networks with considerably less time and effort than before.

Friendly and Secure Management

For efficient management, PLANET LRP Managed Switch is equipped with console, **Web**, **Telnet** and **SNMP** management interfaces. With the built-in Web-based management interface, PLANET LRP Managed Switch offers an easy-to-use, platform-independent management and configuration facility. By supporting the standard Simple Network Management Protocol (SNMP), the switch can be managed via any standard management software. For text-based management, the switch can be accessed via Telnet and the console port. Moreover, PLANET LRP Managed Switch offers secure remote management by supporting **SSH**, **SSL** and **SNMP v3** connections which encrypt the packet content at each session.

Flexibility and Long-distance Extension Solution

PLANET LRP Managed Switch provides two Gigabit TP interfaces supporting 10/100/1000BASE-T RJ45 copper to be connected with surveillance network devices such as NVR, Video Streaming Server or NAS to facilitate surveillance management. Or through another two **dual-speed fiber SFP slots**, it can connect with the **100BASE-FX/1000BASE-SX/LX SFP** (Small Form-factor Pluggable) fiber transceiver to uplink to backbone switch and monitoring center in long distance. The distance can be extended from 550 meters to 2 kilometers (multi-mode fiber) and up to 10/20/30/40/50/70/120 kilometers (single-mode fiber or WDM fiber). The LRP Managed Switch is well suited for applications within the enterprise data centers and distributions.

Intelligent SFP Diagnosis Mechanism

PLANET LRP Managed Switch also supports **SFP-DDM (Digital Diagnostic Monitor)** function that can easily monitor real-time parameters of the SFP for network administrator, such as optical output power, optical input power, temperature, laser bias current and transceiver supply voltage.

1.3 How to Use This Manual

This User Manual is structured as follows:

Section 2, INSTALLATION

The section explains the functions of the Switch and how to physically install the LRP Managed Switch.

Section 3, SWITCH MANAGEMENT

The section contains the information about the software function of the LRP Managed Switch.

Section 4, WEB CONFIGURATION

The section explains how to manage the LRP Managed Switch by Web interface.

Section 5, SWITCH OPERATION

The chapter explains how to do the switch operation of the LRP Managed Switch.

Section 6, TROUBLESHOOTING

The chapter explains how to troubleshoot the LRP Managed Switch.

Appendix A

The section contains cable information of the LRP Managed Switch.

1.4 Product Features

▶ Physical Port

- 100Mbps BNC female ports with Long Reach PoE Injector function
- 2 10/100/1000BASE-T Gigabit RJ45 copper ports
- 2 100/1000BASE-X mini-GBIC/SFP slots
- RJ45 console interface for switch basic management and setup

▶ Long Reach Power over Ethernet

- Supports PoE power up to 36 watts for each PoE port
- Remote power feeding up to 1 kilometer with 5C2V/RG6 75Ω coaxial cable
- Long Reach PoE Management
 - Total Long Reach PoE power budget control
 - Per port Long Reach PoE function enable/disable
 - Long Reach PoE port power feeding priority
 - Per Long Reach PoE port power limitation
 - Long Reach PD alive check
 - Long Reach PoE schedule

▶ **Layer 2 Features**

- Prevents packet loss with back pressure (half-duplex) and IEEE 802.3x pause frame flow control (full-duplex)
- High performance Store and Forward architecture, broadcast storm control, runt/CRC filtering that eliminates erroneous packets to optimize the network bandwidth
- Supports **VLAN**
 - IEEE 802.1Q tagged VLAN
 - Provider Bridging (VLAN Q-in-Q) support (IEEE 802.1ad)
 - Protocol VLAN
 - Voice VLAN
 - Private VLAN
 - Management VLAN
 - GVRP
- Supports **Spanning Tree Protocol**
 - STP (Spanning Tree Protocol)
 - RSTP (Rapid Spanning Tree Protocol)
 - MSTP (Multiple Spanning Tree Protocol)
 - STP BPDU Guard, BPDU Filtering and BPDU Forwarding
- Supports **Link Aggregation**
 - IEEE 802.3ad Link Aggregation Control Protocol (LACP)
 - Cisco ether-channel (static trunk)
 - Maximum 4 trunk groups, up to 4 ports per trunk group
- Provides port mirror (many-to-1)
- Loop protection to avoid broadcast loops

▶ **Quality of Service**

- Ingress/Egress rate limit per port bandwidth control
- Storm control support
 - Broadcast/Unknown unicast/Unknown multicast
- Traffic classification
 - IEEE 802.1p CoS
 - ToS/DSCP/IP Precedence of IPv4/IPv6 packets
- Strict priority and Weighted Round Robin (WRR) CoS policies

▶ **Multicast**

- Supports IGMP snooping v2 and v3
- Supports MLD snooping v1, v2
- IGMP querier mode support
- IGMP snooping port filtering
- MLD snooping port filtering

▶ **Security**

- Authentication
 - IEEE 802.1x port-based network access authentication
 - Built-in RADIUS client to co-operate with the RADIUS servers
 - RADIUS/TACACS+ login user access authentication
- Access Control List
 - IPv4/IPv6 IP-based ACL
 - MAC-based ACL
- MAC Security
 - Static MAC
 - MAC filtering
- Port security for source MAC address entries filtering
- DHCP snooping to filter untrusted DHCP messages
- Dynamic ARP inspection discards ARP packets with invalid MAC address to IP address binding
- IP source guard prevents IP spoofing attacks
- DoS attack prevention
- SSH / SSL

▶ **Management**

- IPv4 and IPv6 dual stack management
- Switch management interface
 - Web switch management
 - Telnet command line interface
 - SNMP v1, v2c and v3
 - SSH / SSL secure access
- User privilege levels control
- Built-in Trivial File Transfer Protocol (TFTP) client
- BOOTP and DHCP for IP address assignment
- System maintenance
 - Firmware upload/download via HTTP/TFTP
 - Configuration upload/download through Web interface
 - Dual images
 - Hardware reset button for system reboot or reset to factory default
- SNTP Network Time Protocol
- Cable diagnostics
- Link Layer Discovery Protocol (LLDP) and LLDP-MED
- SNMP trap for interface linkup and linkdown notification
- Event message logging to remote Syslog server
- Four RMON groups (history, statistics, alarms and events)
- PLANET Smart Discovery utility
- Smart fan with speed control

1.5 Product Specifications

| Model | | LRP-822CS | LRP-1622CS | | | |
|--------------------------------|------------------------------|--|--------------------------------|-------------------|------------------------------|-------|
| Hardware Specifications | | | | | | |
| Ethernet Interfaces | Copper | 2 x 10/100/1000BASE-T RJ45 Auto-negotiation/ Auto-MDI/MDI-X | | | | |
| | Fiber Optic | 2 x 100/1000BASE-X SFP slot Supports 100/1000Mbps dual mode and DDM | | | | |
| | Jumbo Frame | 10Kbytes with GE1 to GE4 | | | | |
| Long Reach PoE Interfaces | Connectivity | 8 x BNC female connectors | 16 x BNC female connectors | | | |
| | | Long Reach PoE over coaxial PSE (Power Source Equipment) <ul style="list-style-type: none"> ■ BNC center pole : DC+ / Hi ■ BNC shield : DC - / Lo | | | | |
| | Power Output | Per port 54V DC, 36 watts max. | Per port 52V DC, 36 watts max. | | | |
| | Total Power Budget | 240 watts (max.) | 440 watts (max.) | | | |
| | Cabling | Coaxial cable: 75 ohm RG-6/U cable (Recommended) | | | | |
| | Maximum Distance | Max. 200m with PoE+ output (656ft.) Max. 400m with PoE output (1,312ft.) Max. 1000m with PoE output (3,280ft.) Max. 1200m without PoE output (3,937ft.) | | | | |
| | Long Reach Ethernet Standard | IEEE 1901 | | | | |
| | Modulation Type | Wavelet-OFDM | | | | |
| | Security | 128-bit AES encryption | | | | |
| | Frequency Band | 2 ~ 28MHz | | | | |
| Performance | [LRP-822CS] | | | | | |
| | | Distance | Cable Type | Data Rate* | LRP-101CE PoE Output* | |
| | | | | TX** | RX** | |
| | | 200m | RG6 | 91.8Mbps | 81.1Mbps | 22.9W |
| | | 400m | RG6 | 85.5Mbps | 66.9Mbps | 18.7W |
| | | 600m | RG6 | 76.5Mbps | 54.2Mbps | 15.0W |
| | | 800m | RG6 | 67.9Mbps | 49.2Mbps | 10.4W |
| | | 1000m | RG6 | 26.6Mbps | 25.6Mbps | 7.8W |
| | 1200m | RG6 | 25.6Mbps | 25.0Mbps | --- | |

| | | <p>[LRP-1622CS]</p> <table border="1"> <thead> <tr> <th rowspan="2">Distance</th> <th rowspan="2">Cable Type</th> <th colspan="2">Data Rate*</th> <th>LRP-101CE</th> </tr> <tr> <th>TX**</th> <th>RX**</th> <th>PoE Output*</th> </tr> </thead> <tbody> <tr> <td>200m</td> <td>RG6</td> <td>74.8Mbps</td> <td>81.7Mbps</td> <td>19.8W</td> </tr> <tr> <td>400m</td> <td>RG6</td> <td>62.5Mbps</td> <td>75.2Mbps</td> <td>15.8W</td> </tr> <tr> <td>600m</td> <td>RG6</td> <td>57.8Mbps</td> <td>70.3Mbps</td> <td>11.8W</td> </tr> <tr> <td>800m</td> <td>RG6</td> <td>41.7Mbps</td> <td>67.1Mbps</td> <td>7.9W</td> </tr> <tr> <td>1000m</td> <td>RG6</td> <td>31.7Mbps</td> <td>58.8Mbps</td> <td>6.7W</td> </tr> <tr> <td>1200m</td> <td>RG6</td> <td>14.9Mbps</td> <td>22.5Mbps</td> <td>---</td> </tr> </tbody> </table> <p>* The actual data rate and PoE output vary on the quality of the copper wire and environmental factors. The performance result above is based on the testing via the RG-6/U coaxial cable.</p> <p>** TX: LRP-822CS to LRP-101CE; RX: LRP-101CE to LRP-822CS.</p> | | | Distance | Cable Type | Data Rate* | | LRP-101CE | TX** | RX** | PoE Output* | 200m | RG6 | 74.8Mbps | 81.7Mbps | 19.8W | 400m | RG6 | 62.5Mbps | 75.2Mbps | 15.8W | 600m | RG6 | 57.8Mbps | 70.3Mbps | 11.8W | 800m | RG6 | 41.7Mbps | 67.1Mbps | 7.9W | 1000m | RG6 | 31.7Mbps | 58.8Mbps | 6.7W | 1200m | RG6 | 14.9Mbps | 22.5Mbps | --- |
|-------------------------------|---|--|-------------------------|-------------|----------|------------|------------|--|-----------|------|------|-------------|------|-----|----------|----------|-------|------|-----|----------|----------|-------|------|-----|----------|----------|-------|------|-----|----------|----------|------|-------|-----|----------|----------|------|-------|-----|----------|----------|-----|
| Distance | Cable Type | Data Rate* | | LRP-101CE | | | | | | | | | | | | | | | | | | | | | | | | | | | | | | | | | | | | | | |
| | | TX** | RX** | PoE Output* | | | | | | | | | | | | | | | | | | | | | | | | | | | | | | | | | | | | | | |
| 200m | RG6 | 74.8Mbps | 81.7Mbps | 19.8W | | | | | | | | | | | | | | | | | | | | | | | | | | | | | | | | | | | | | | |
| 400m | RG6 | 62.5Mbps | 75.2Mbps | 15.8W | | | | | | | | | | | | | | | | | | | | | | | | | | | | | | | | | | | | | | |
| 600m | RG6 | 57.8Mbps | 70.3Mbps | 11.8W | | | | | | | | | | | | | | | | | | | | | | | | | | | | | | | | | | | | | | |
| 800m | RG6 | 41.7Mbps | 67.1Mbps | 7.9W | | | | | | | | | | | | | | | | | | | | | | | | | | | | | | | | | | | | | | |
| 1000m | RG6 | 31.7Mbps | 58.8Mbps | 6.7W | | | | | | | | | | | | | | | | | | | | | | | | | | | | | | | | | | | | | | |
| 1200m | RG6 | 14.9Mbps | 22.5Mbps | --- | | | | | | | | | | | | | | | | | | | | | | | | | | | | | | | | | | | | | | |
| | Multiple Nodes | <p>Up to 4 LRP extenders within 1km RG-6/U coaxial cable*</p> <p>* The actual extender nodes vary on the quality of the copper wire and environmental factors.</p> | | | | | | | | | | | | | | | | | | | | | | | | | | | | | | | | | | | | | | | | |
| | LRP Compatibility | <p>LRP-101CE: 1-Port 10/100TX PoE PSE + 1-Port Coax Long Reach PoE Extender</p> | | | | | | | | | | | | | | | | | | | | | | | | | | | | | | | | | | | | | | | | |
| Console | 1 x RS232-to-RJ45 serial port (115200, 8, N, 1) | | | | | | | | | | | | | | | | | | | | | | | | | | | | | | | | | | | | | | | | | |
| Switch Architecture | Store-and-Forward | | | | | | | | | | | | | | | | | | | | | | | | | | | | | | | | | | | | | | | | | |
| Switch Fabric | 9.6Gbps / non-blocking | | 11.2Gbps / non-blocking | | | | | | | | | | | | | | | | | | | | | | | | | | | | | | | | | | | | | | | |
| Address Table | 8K entries | | | | | | | | | | | | | | | | | | | | | | | | | | | | | | | | | | | | | | | | | |
| Shared Data Buffer | 4.1 megabits | | | | | | | | | | | | | | | | | | | | | | | | | | | | | | | | | | | | | | | | | |
| Flow Control | IEEE 802.3x pause frame for full-duplex Back pressure for half-duplex | | | | | | | | | | | | | | | | | | | | | | | | | | | | | | | | | | | | | | | | | |
| Reset Button | < 5 sec: System reboot > 5 sec: Factory default | | | | | | | | | | | | | | | | | | | | | | | | | | | | | | | | | | | | | | | | | |
| LED | PWR, SYS, LNK, PoE-in-Use, 1000, LNK/ACK, Fan 1 Alert, Fan 2 Alert, PoE PWR Alert | | | | | | | | | | | | | | | | | | | | | | | | | | | | | | | | | | | | | | | | | |
| Dimensions (W x D x H) | 440 x 300 x 44.5 mm, 1U height | | | | | | | | | | | | | | | | | | | | | | | | | | | | | | | | | | | | | | | | | |
| Weight | 4282g | | 4430g | | | | | | | | | | | | | | | | | | | | | | | | | | | | | | | | | | | | | | | |
| Power Requirements | AC 100~240V, 50/60Hz, auto-sensing | | | | | | | | | | | | | | | | | | | | | | | | | | | | | | | | | | | | | | | | | |
| ESD Protection | 6KV DC | | | | | | | | | | | | | | | | | | | | | | | | | | | | | | | | | | | | | | | | | |
| Power Consumption | 320 watts / 1091.8 BTU | | 540watts / 1843BTU | | | | | | | | | | | | | | | | | | | | | | | | | | | | | | | | | | | | | | | |
| Enclosure | Metal | | | | | | | | | | | | | | | | | | | | | | | | | | | | | | | | | | | | | | | | | |
| Layer 2 Functions | | | | | | | | | | | | | | | | | | | | | | | | | | | | | | | | | | | | | | | | | | |
| Port Mirroring | TX / RX / both | | | | | | | | | | | | | | | | | | | | | | | | | | | | | | | | | | | | | | | | | |

| | |
|-------------------------------------|---|
| | Many-to-1 monitor |
| VLAN | 802.1Q tagged-based VLAN Up to 256 VLAN groups, out of 4094 VLAN IDs 802.1ad Q-in-Q tunneling Voice VLAN Protocol VLAN Private VLAN (Protected port) GVRP |
| Link Aggregation | IEEE 802.3ad LACP and static trunk Supports 4 groups of 4-port trunk |
| Spanning Tree Protocol | STP / RSTP / MSTP |
| IGMP Snooping | IGMP (v2/v3) Snooping IGMP Querier Up to 256 multicast groups |
| MLD Snooping | MLD (v1/v2) Snooping, up to 256 multicast groups |
| Access Control List | IPv4/IPv6 IP-based ACL / MAC-based ACL |
| QoS | 8 mapping ID to 8 level priority queues - Port number - 802.1p priority - 802.1Q VLAN tag - DSCP field in IP packet Traffic classification based, strict priority and WRR |
| Security | IEEE 802.1X– Port-based authentication Built-in RADIUS client to co-operate with RADIUS server RADIUS / TACACS+ user access authentication IP-MAC port binding MAC filter Static MAC address DHCP Snooping and DHCP Option 82 STP BPDU guard, BPDU filtering and BPDU forwarding DoS attack prevention ARP inspection IP source guard |
| Management Functions | |
| Basic Management Interfaces | Web browser / Telnet / SNMP v1, v2c Firmware upgrade by HTTP / TFTP protocol through Ethernet network Remote / Local Syslog System log LLDP protocol SNTP |
| Secure Management Interfaces | SSH, SSL, SNMP v3 |
| SNMP MIBs | RFC 1213 MIB-II RFC 1215 Generic Traps RFC 1493 Bridge MIB RFC 2674 Bridge MIB Extensions RFC 2737 Entity MIB (Version 2) |

| | |
|------------------------------|---|
| | <p>RFC 2819 RMON (1, 2, 3, 9) RFC 2863 Interface Group MIB RFC 3635 Ethernet-like MIB</p> |
| Standards Conformance | |
| Regulation Compliance | FCC Part 15 Class A, CE |
| Standards Compliance | <p>IEEE 1901 Broadband Power Line IEEE 802.3 10BASE-T IEEE 802.3u 100BASE-TX/100BASE-FX IEEE 802.3z Gigabit SX/LX IEEE 802.3ab Gigabit 1000T IEEE 802.3x flow control and back pressure IEEE 802.3ad port trunk with LACP IEEE 802.1D Spanning Tree Protocol IEEE 802.1w Rapid Spanning Tree Protocol IEEE 802.1s Multiple Spanning Tree Protocol IEEE 802.1p Class of Service IEEE 802.1Q VLAN tagging IEEE 802.1X Port Authentication Network Control IEEE 802.1ab LLDP RFC 768 UDP RFC 793 TFTP RFC 791 IP RFC 792 ICMP RFC 2068 HTTP RFC 1112 IGMP version 1 RFC 2236 IGMP version 2 RFC 3376 IGMP version 3 RFC 2710 MLD version 1 RFC 3810 MLD version 2</p> |
| Environment | |
| Operating | <p>Temperature: 0 ~ 50 degrees C Relative Humidity: 5 ~ 95% (non-condensing)</p> |
| Storage | <p>Temperature: -10 ~ 70 degrees C Relative Humidity: 5 ~ 95% (non-condensing)</p> |

2. INSTALLATION

This section describes the hardware features and installation of the LRP Managed Switch on the desktop or rack mount. For easier management and control of the LRP Managed Switch, familiarize yourself with its display indicators, and ports. Front panel illustrations in this chapter display the unit LED indicators. Before connecting any network device to the LRP Managed Switch, please read this chapter completely.

2.1 Hardware Description

2.1.1 Switch Front Panel

The front panel provides a simple interface monitoring of the LRP Managed Switch. [Figures 2-1-1A and 2-1-1B](#) show the front panels of the LRP Managed Switches.

Front Panel



Figure 2-1-1A LRP-822CS Front Panel

Front Panel

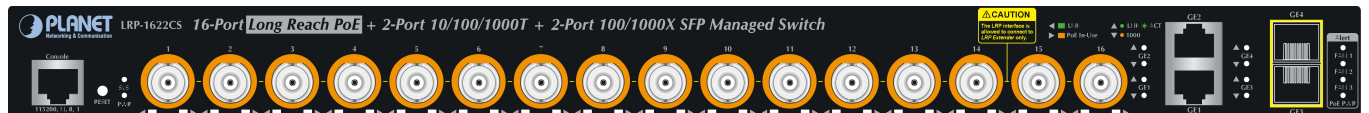

Figure 2-1-1B LRP-1622CS Front Panel

■ Long Reach PoE BNC Interface

BNC female port, 5C2V/RG6 75Ω coaxial cable: Up to 1 kilometer.

■ Gigabit TP Interface

10/100/1000BASE-T Copper, RJ45 Twisted-pair: Up to 100 meters.

■ 100/1000BASE-X SFP Slots

Each of the SFP (Small Form-factor Pluggable) slots supports dual-speed, 1000BASE-SX / LX or 100BASE-FX

- For 1000BASE-SX/LX SFP transceiver module: From 550 meters (multi-mode fiber) to 10/30/50/70/120 kilometers (single-mode fiber).
- For 100BASE-FX SFP transceiver module: From 2 kilometers (multi-mode fiber) to 20/40/60 kilometers (single-mode fiber).

■ **Console Port**

The console port is a RJ45 port connector. It is an interface for connecting a terminal directly. Through the console port, it provides rich diagnostic information including IP Address setting, factory reset, port management, link status and system setting.

Users can use the attached DB9 to RJ45 console cable in the package and connect to the console port on the device. After the connection, users can run any terminal emulation program (Hyper Terminal, ProComm Plus, Telix, Winterm and so on) to enter the startup screen of the device.

■ **Reset Button**

On the left of the front panel, the reset button is designed to reboot the LRP Managed Switch without turning off and on the power. The following is the summary table of the Reset button functions:

| Reset Button Pressed and Released | Function |
|-----------------------------------|--|
| < 5 sec: System Reboot | Reboot the LRP Managed Switch. |
| > 5 sec: Factory Default | Reset the LRP Managed Switch to the Factory Default configuration. The LRP Managed Switch will then reboot and load the default settings shown below: <ul style="list-style-type: none"> ◦ Default Username: admin ◦ Default Password: admin ◦ Default IP Address: 192.168.0.100 ◦ Subnet Mask: 255.255.255.0 ◦ Default Gateway: 192.168.0.254 |

2.1.2 LED Indications

The front panel LEDs indicates instant status of port links, data activity and system power; it helps monitor and troubleshoot when needed. Figures 2-1-2A and 2-1-2B show the LED indications of these LRP Managed Switches.

LRP-822CS LED Indication



Figure 2-1-2 LRP-822CS LED Panel

System / Alert

| LED | Color | Function |
|-------|-------|---|
| PWR | Green | Lights to indicate that the Switch has power. |
| SYS | Green | Lights to indicate the system is working. Off to indicate the system is booting. |
| FAN 1 | Red | Lights to indicate that Fan 1 is down. |
| FAN 2 | Red | Lights to indicate that Fan 2 is down. |
| FAN 3 | Red | Lights to indicate that Fan 3 is down. |
| PWR | Red | Lights to indicate that the PoE Power is down. |

Long Reach PoE Interfaces (Port-1 to Port-8)

| LED | Color | Function |
|-----|--------|--|
| LNK | Green | Lights To indicate the link through that port is successfully established. |
| PoE | Orange | Lights To indicate the port is providing DC in-line power. |

10/100/1000BASE-T Interfaces (GE1 to GE2)

| LED | Color | Function |
|---------|--------|--|
| LNK/ACT | Green | Lights To indicate the link through that port is successfully established. Blinking To indicate that the switch is actively sending or receiving data over that port. |
| 1000 | Orange | Lights To indicate that the port is operating at 1000Mbps . |
| | | Lights When LNK/ACT LED lights up, it indicates that the port is operating at 10/100Mbps . |
| | | Off When LNK/ACT LED is off, it indicates that the port is linkdown. |

■ 1000BASE-SX/LX SFP Interfaces (GE3 to GE4)

| LED | Color | Function |
|---------|--------|--|
| LNK/ACT | Green | Lights To indicate the link through that port is successfully established. |
| | | Blinking To indicate that the switch is actively sending or receiving data over that port. |
| 1000 | Orange | Lights To indicate that the port is operating at 1000Mbps . |
| | | Lights When LNK/ACT LED lights up, it indicates that the port is operating at 10/100Mbps . |
| | | Off When LNK/ACT LED is off, it indicates that the port is linkdown. |

LRP-1622CS LED Indication



Figure 2-1-2B LRP-1622CS LED Panel

■ System / Alert

| LED | Color | Function |
|-------|-------|---|
| PWR | Green | Lights to indicate that the Switch has power. |
| SYS | Green | Lights to indicate the system is working. |
| | | Off to indicate the system is booting. |
| FAN 1 | Red | Lights to indicate that Fan 1 is down. |
| FAN 2 | Red | Lights to indicate that Fan 2 is down. |
| FAN 3 | Red | Lights to indicate that Fan 3 is down. |
| PWR | Red | Lights to indicate that the PoE Power is down. |

■ Long Reach PoE Interfaces (Port-1 to Port-16)

| LED | Color | Function |
|-----|--------|---|
| LNK | Green | Lights To indicate the link through that port is successfully established. |
| PoE | Orange | Lights To indicate the port is providing DC in-line power. |

■ 10/100/1000BASE-T Interfaces (GE1 to GE2)

| LED | Color | Function |
|---------|--------|---|
| LNK/ACT | Green | Lights To indicate the link through that port is successfully established. |
| | | Blinking To indicate that the switch is actively sending or receiving data over that port. |
| 1000 | Orange | Lights To indicate that the port is operating at 1000Mbps . |

| | | | |
|--|--|---------------|--|
| | | Lights | If LNK/ACT LED lights up, it indicates that the port is operating at 10/100Mbps . |
| | | Off | If LNK/ACT LED is off, it indicates that the port is linkdown. |

■ **1000BASE-SX/LX SFP Interfaces (GE3 to GE4)**

| LED | Color | Function | |
|---------|--------|-----------------|---|
| LNK/ACT | Green | Lights | To indicate the link through that port is successfully established. |
| | | Blinking | To indicate that the switch is actively sending or receiving data over that port. |
| 1000 | Orange | Lights | To indicate that the port is operating at 1000Mbps . |
| | | Lights | If LNK/ACT LED lights up, it indicates that the port is operating at 100Mbps . |
| | | Off | If LNK/ACT LED is off, it indicates that the port is linkdown. |

2.1.3 Switch Rear Panel

The rear panel of the LRP Managed Switch has an AC power socket, which accepts voltage from 100 to 240V AC at 50-60Hz.

Figure 2-1-3 shows the rear panel of these LRP Managed Switches.

Rear Panel



Figure 2-1-3 Rear Panel of LRP-822CS/LRP-1622CS

■ **AC Power Receptacle**

For compatibility with electric service in most areas of the world, the LRP Managed Switch's power supply automatically adjusts to line power in the range of 100-240V AC at 50/60 Hz.

Plug the female end of the power cord firmly into the receptacle on the rear panel of the LRP Managed Switch. Plug the other end of the power cord into an electrical outlet and the power will be ready.

Power Notice: The device is a power-required device, which means it will not work till it is powered. If your networks should be active all the time, please consider using UPS (Uninterrupted Power Supply) for your device. It will prevent you from network data loss or network downtime.

Power Notice: In some areas, installing a surge suppression device may also help to protect your LRP Managed Switch from being damaged by unregulated surge or current to the LRP Managed Switch.

2.2 Installing the Switch

This section describes how to install your LRP Managed Switch and make connections to the LRP Managed Switch. Please read the following topics and perform the procedures in the order being presented. To install your LRP Managed Switch on a desktop or shelf, simply complete the following steps.

2.2.1 Desktop Installation

To install the LRP Managed Switch on desktop or shelf, please follow these steps:

Step 1: Attach the rubber feet to the recessed areas on the bottom of the LRP Managed Switch.

Step 2: Place the LRP Managed Switch on the desktop or the shelf near an AC power source, as shown in Figure 2-1-4.

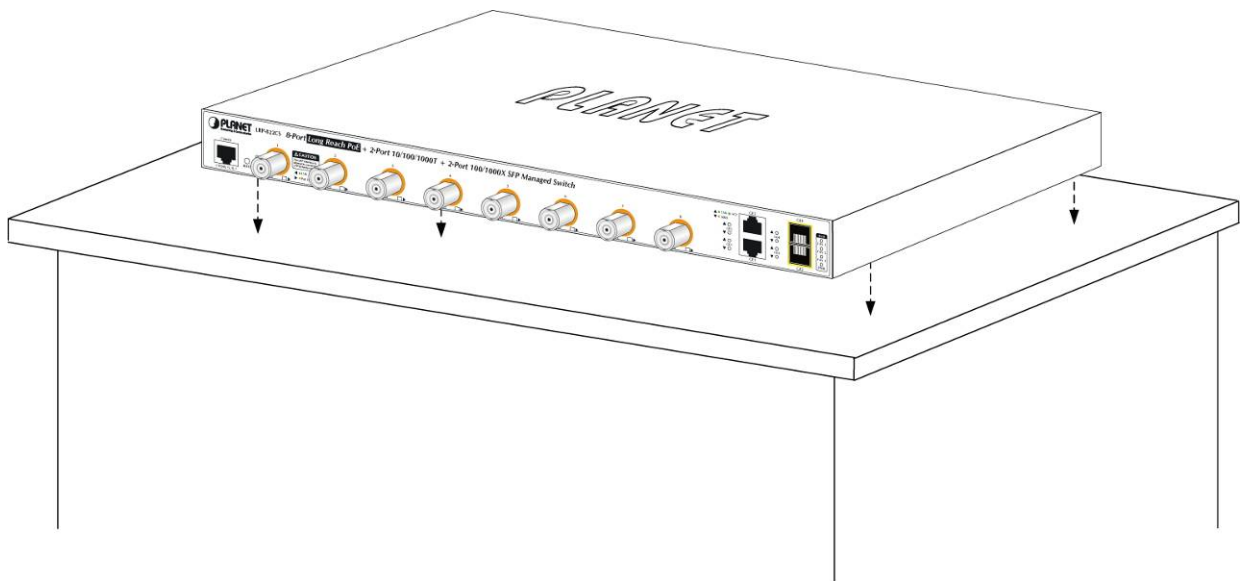

Figure 2-1-4 Place the LRP Managed Switch on the desktop

Step 3: Keep enough ventilation space between the LRP Managed Switch and the surrounding objects.



When choosing a location, please keep in mind the environmental restrictions discussed in Chapter 1, Section 4 under specifications.

Step 4: Connect the LRP Managed Switch to network devices.

Connect one end of a standard network cable to the 10/100/1000 RJ45 ports and standard coaxial cable to LRP ports on the front of the LRP Managed Switch. Connect the other end of the cable to the network devices such as printer server, workstation or router.



Connection to the LRP Managed Switch requires UTP Category 5 network cabling with RJ45 tips. For more information, please see the Cabling Specification in Appendix A.

Step 5: Supply power to the LRP Managed Switch.

Connect one end of the power cable to the LRP Managed Switch. Connect the power plug of the power cable to a standard wall outlet. When the LRP Managed Switch receives power, the Power LED should remain solid Green.

2.2.2 Rack Mounting

To install the LRP Managed Switch in a 19-inch standard rack, please follow the instructions described below.

Step 1: Place the LRP Managed Switch on a hard flat surface, with the front panel positioned towards the front side.

Step 2: Attach the rack-mount bracket to each side of the LRP Managed Switch with supplied screws attached to the package.

Figure 2-1-5 shows how to attach brackets to one side of the LRP Managed Switch.



Figure 2-1-5 Attach Brackets to the LRP Managed Switch.



You must use the screws supplied with the mounting brackets. Damage caused to the parts by using incorrect screws would invalidate the warranty.

Step 3: Secure the brackets tightly.

Step 4: Follow the same steps to attach the second bracket to the opposite side.

Step 5: After the brackets are attached to the LRP Managed Switch, use suitable screws to securely attach the brackets to the rack, as shown in Figure 2-1-6.

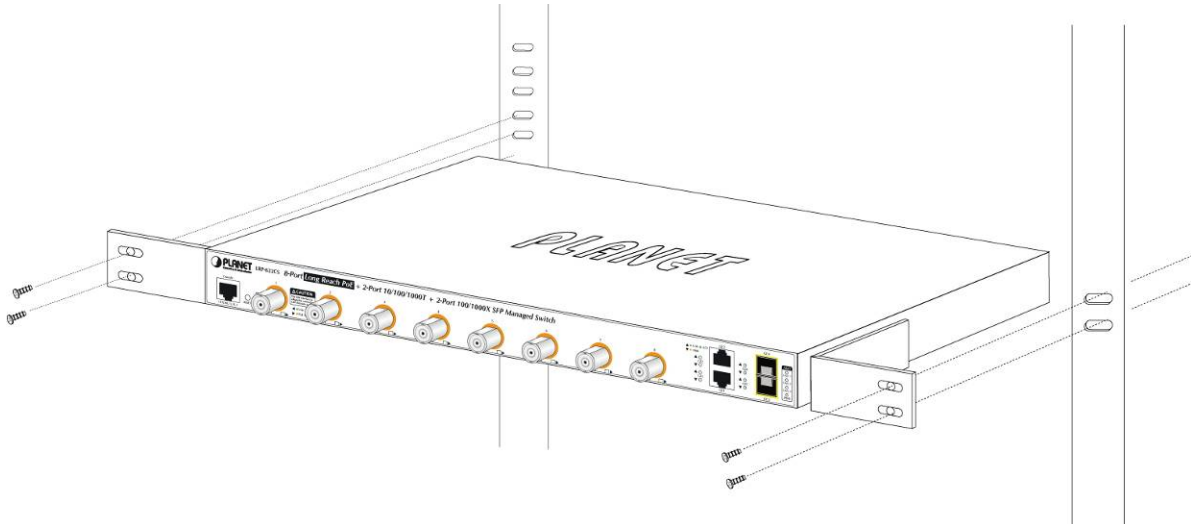

Figure 2-1-6 Mounting LRP Managed Switch in a Rack

Step 6: Proceeds with Steps 4 and 5 of session 2.2.1 Desktop Installation to connect the network cabling and supply power to the LRP Managed Switch.

2.2.3 Installing the SFP transceiver

The sections describe how to insert an SFP transceiver into an SFP slot. The SFP transceivers are hot-pluggable and hot-swappable. You can plug in and out the transceiver to/from any SFP port without having to power down the LRP Managed Switch as Figure 2-1-7 shows.

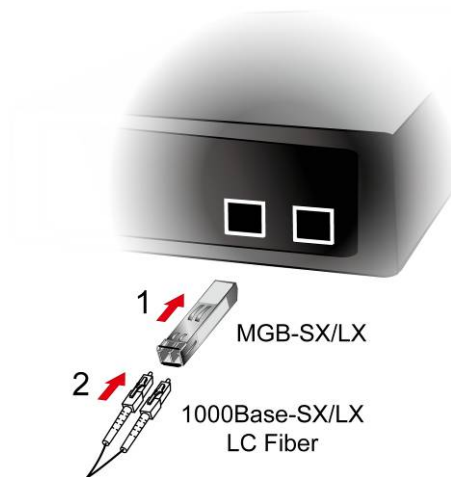

Figure 2-1-7 Plug in the SFP transceiver

■ Approved PLANET SFP Transceivers

PLANET LRP Managed Switch supports both single mode and multi-mode SFP transceivers. The following list of approved PLANET SFP transceivers is correct at the time of publication:

Gigabit SFP Transceiver Modules

- **MGB-GT** SFP-Port 1000BASE-T Module
- **MGB-SX** SFP-Port 1000BASE-SX mini-GBIC module
- **MGB-LX** SFP-Port 1000BASE-LX mini-GBIC module
- **MGB-L50** SFP-Port 1000BASE-LX mini-GBIC module – 50km
- **MGB-L70** SFP-Port 1000BASE-LX mini-GBIC module – 70km
- **MGB-L120** SFP-Port 1000BASE-LX mini-GBIC module – 120km
- **MGB-LA10** SFP-Port 1000BASE-LX (WDM,TX:1310nm) – 10km
- **MGB-LA20** SFP-Port 1000BASE-LX (WDM,TX:1310nm) – 20km
- **MGB-LB20** SFP-Port 1000BASE-LX (WDM,TX:1550nm) – 20km
- **MGB-LA40** SFP-Port 1000BASE-LX (WDM,TX:1310nm) – 40km
- **MGB-LB40** SFP-Port 1000BASE-LX (WDM,TX:1550nm) – 40km

Fast Ethernet SFP Transceiver Modules

- **MFB-FX** SFP-Port 100BASE-FX Transceiver – 2km
- **MFB-F20** SFP-Port 100BASE-FX Transceiver – 20km
- **MFB-F60** SFP-Port 100BASE-FX Transceiver – 60km
- **MFB-FA20** SFP-Port 100BASE-BX Transceiver (WDM,TX:1310nm) – 20km
- **MFB-FB20** SFP-Port 100BASE-BX Transceiver (WDM,TX:1550nm) – 20km



It is recommended to use PLANET SFP on the LRP Managed Switch. If you insert an SFP transceiver that is not supported, the LRP Managed Switch will not recognize it.



In the installation steps below, this Manual uses Gigabit SFP transceiver as an example. However, the steps for Fast Ethernet SFP transceiver are similar.

1. Before we connect LRP Managed Switch to the other network device, we have to make sure both sides of the SFP transceivers are with the same media type, for example, 1000BASE-SX to 1000BASE-SX, 1000BASE-LX to 1000BASE-LX.
2. Check whether the fiber-optic cable type matches with the SFP transceiver requirement.
 - To connect to 1000BASE-SX SFP transceiver, please use the multi-mode fiber cable with one side being the male duplex LC connector type.
 - To connect to 1000BASE-LX SFP transceiver, please use the single-mode fiber cable with one side being the male duplex LC connector type.

■ **Connect the Fiber Cable**

1. Insert the duplex LC connector into the SFP transceiver.
2. Connect the other end of the cable to a device with SFP transceiver installed.
3. Check the LNK/ACT LED of the SFP slot on the front of the LRP Managed Switch. Ensure that the SFP transceiver is operating correctly.
4. Check the Link mode of the SFP port if the link fails. To function with some fiber-NICs or media converters, user has to set the port Link mode to “**1000 Force**” or “**100 Force**”.

■ **Remove the Transceiver Module**

1. Make sure there is no network activity anymore.
2. Remove the fiber-optic cable gently.
3. Lift up the lever of the MGB module and turn it to a horizontal position.
4. Pull out the module gently through the lever.



Figure 2-1-8 How to Pull Out the SFP Transceiver

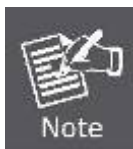

Never pull out the module without lifting up the lever of the module and turning it into a horizontal position. Directly pulling out the module could damage the module and the SFP module slot of the LRP Managed Switch.

2.2.4 Installing the Long Reach PoE Communication

The sections describe how to insert a coaxial cable into a BNC female port. You can plug in and out the coaxial cable to/from any BNC female port without having to power down the LRP Managed Switch.

■ Approved PLANET Long Reach PoE Extenders

The following list of approved PLANET Long Reach PoE extenders is correct at the time of publication:

Long Reach Ethernet Coaxial Extenders

- **LRP-101CE** 1-Port 10/100TX PoE PSE + 1-Port Coax Long Reach PoE Extender



It is recommended to use PLANET Long Reach Ethernet coaxial extenders on the LRP Managed Switch. If you insert a coaxial extender that is not supported, the LRP Managed Switch may damage it.

1. Before we connect LRP Managed Switch to the other network device, we have to make sure both sides of the Long Reach Ethernet coaxial extender/transceiver are with the same media type.
2. Check whether the coaxial cable type matches with the Long Reach Ethernet coaxial extender/transceiver requirement.
 - To connect to LRP Managed Switch, please use the coaxial cable with 75Ω BNC plug with one side being the BNC plug connector type.
 - To connect to Long Reach Ethernet coaxial extenders, please use the coaxial cable with one side being the 75Ω BNC plug connector type.



Because there are various resistance values in the category of RG-59/U or RG-6/U cables, please take care of the conditions of the resistance value of cables as follows:

| Coaxial Cable Type | |
|--------------------|------------------------|
| RG-59/U | Less than 30Ω/1000 ft. |
| RG-6/U | Less than 12Ω/1000 ft |



In the installation steps below, this Manual uses Long Reach Ethernet coaxial extender as an example.

■ Connect the Coaxial Cable

1. Insert the coaxial cable with one side being the 75Ω BNC plug connector into the Long Reach Ethernet coaxial interface.
2. Connect the other end of the cable to a device with **Long Reach Ethernet coaxial extender** installed.

- Tighten the BNC male connector gently.

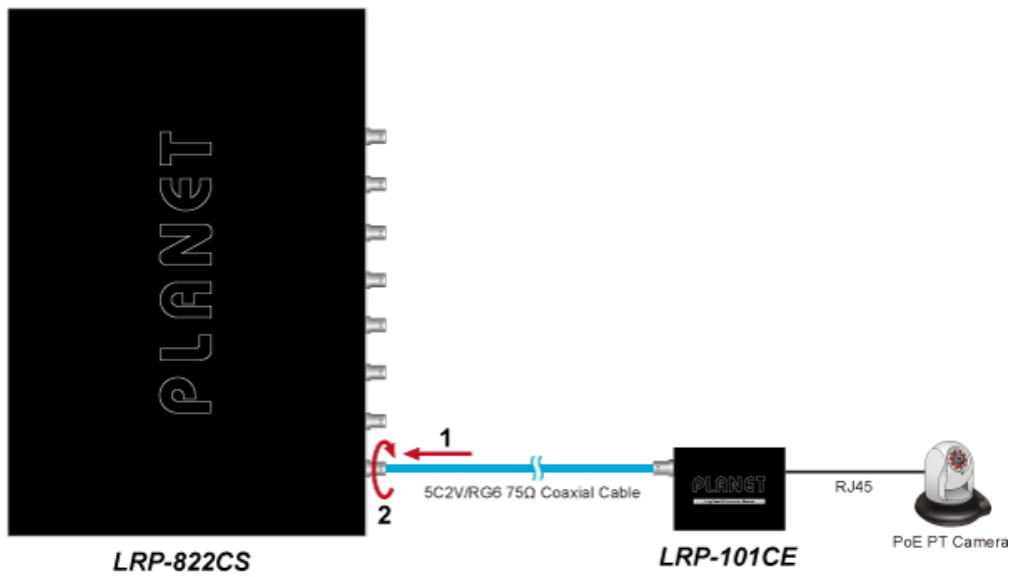

Figure 2-1-8 How to insert the coaxial cable from LRP Managed Switch

- Enable Long Reach Power over Ethernet function for the all LRP ports from WebUI

The screenshot shows the PoE Configuration web interface. At the top, there are navigation links: SAVE | LOGOUT | REBOOT | REFRESH. A left sidebar contains a menu with 'PoE Configuration' highlighted and circled in red, with a red '1' next to it. The main content area is titled 'PoE Configuration' and contains the following settings:

| | |
|-----------------------|--------------|
| System PoE Admin Mode | Enable |
| PoE Management Mode | Enable |
| Temperature Threshold | 64 Degrees C |
| PoE Temperature | 35°C / 95°F |

Below the settings is a 'Power Allocation' section showing a progress bar at 0 W / 240 W. A red '2' is placed over the 'Enable' dropdown in the 'System PoE Admin Mode' setting. At the bottom, there is a table of port configurations and an 'Apply' button circled in red with a red '3' next to it.

| Port | PoE Mode | Schedule | Priority | Current Used [mA] | Power Used [W] | Power Allocation [W] |
|-------|----------|-----------|----------|-------------------|----------------|----------------------|
| 1 | Enable | Profile 1 | Critical | 0 | 0 | 30.8 |
| 2 | Enable | Profile 1 | Critical | 0 | 0 | 30.8 |
| 3 | Enable | Profile 1 | Critical | 0 | 0 | 30.8 |
| 4 | Enable | Profile 1 | Critical | 0 | 0 | 30.8 |
| 5 | Enable | Profile 1 | Critical | 0 | 0 | 30.8 |
| 6 | Enable | Profile 1 | Critical | 0 | 0 | 30.8 |
| 7 | Enable | Profile 1 | Critical | 0 | 0 | 30.8 |
| 8 | Enable | Profile 1 | Critical | 0 | 0 | 30.8 |
| Total | | | | 0 | 0 | 0 |

- Check the LNK LED of the Long Reach Power over Ethernet interface on the front of the LRP Managed Switch. Ensure that the Long Reach Power over Ethernet interface is operating correctly.

■ **Remove the connected the Coaxial Cable**

1. Make sure there is no network activity anymore.
2. Disable Long Reach Power over Ethernet function for the all LRP ports from WebUI.

SAVE | LOGOUT | REBOOT | REFRESH

PoE Configuration

PoE Configuration

| | |
|-----------------------|--------------|
| System PoE Admin Mode | Disable |
| PoE Management Mode | Enable |
| Temperature Threshold | 34 Degrees C |
| PoE Temperature | 35°C / 95°F |

Power Allocation: 0 W / 240 W

| Port | PoE Mode | Schedule | Priority | Current Used [mA] | Power Used [W] | Power Allocation [W] |
|-------|----------|-----------|----------|-------------------|----------------|----------------------|
| 1 | Enable | Profile 1 | Critical | 0 | 0 | 30.8 |
| 2 | Enable | Profile 1 | Critical | 0 | 0 | 30.8 |
| 3 | Enable | Profile 1 | Critical | 0 | 0 | 30.8 |
| 4 | Enable | Profile 1 | Critical | 0 | 0 | 30.8 |
| 5 | Enable | Profile 1 | Critical | 0 | 0 | 30.8 |
| 6 | Enable | Profile 1 | Critical | 0 | 0 | 30.8 |
| 7 | Enable | Profile 1 | Critical | 0 | 0 | 30.8 |
| 8 | Enable | Profile 1 | Critical | 0 | 0 | 30.8 |
| Total | | | | 0 | 0 | 0 |

Apply

3. Loosen the BNC male connector gently.
4. Pull out the coaxial cable gently.

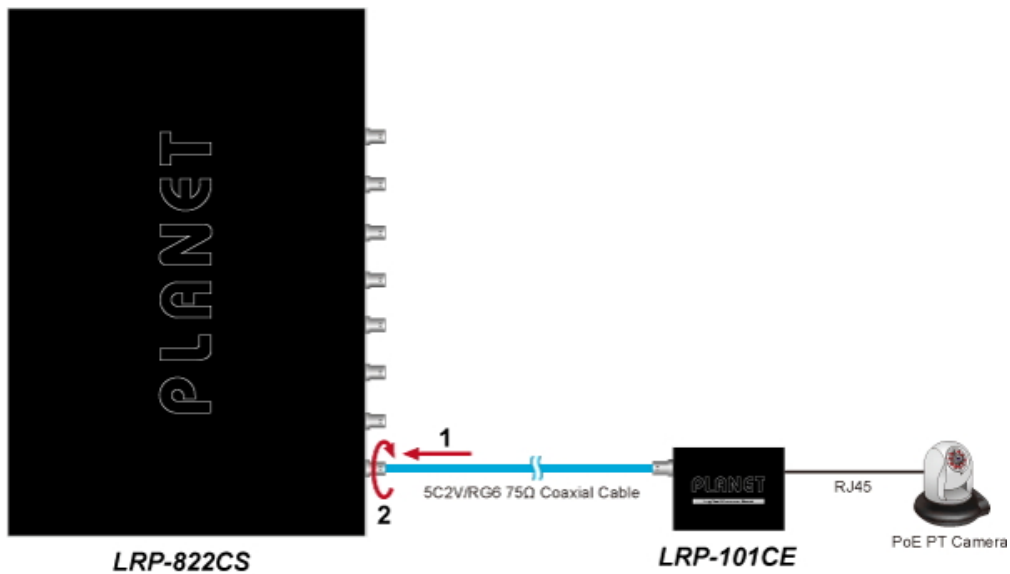

Figure 2-1-8 How to pull out the coaxial cable from LRP Managed Switch



Never pull out the coaxial cable without disabling Long Reach Power over Ethernet function for the port from WebUI. Directly pulling out the coaxial cable could damage the Long Reach Ethernet coaxial extender and the BNC female connector of the LRP Managed Switch.

1. The package contains eight warning stickers, which should be stuck on the coaxial cable connector before using PLANET LRP Managed Switch and LRP extender. If connected with non-PLANET LRP series extender equipment, it might cause damage to the equipment.



2. After the LRP PoE port is enabled, the pin center of the coaxial cable has electricity. Do not touch the pin center or connect this end to any non- PLANET LRP equipment.



3. SWITCH MANAGEMENT

This chapter explains the methods that you can use to configure management access to the LRP Managed Switch. It describes the types of management applications and the communication and management protocols that deliver data between your management device (workstation or personal computer) and the system. It also contains information about port connection options.

This chapter covers the following topics:

- Requirements
- Management Access Overview
- Administration Console Access
- Web Management Access
- SNMP Access
- Standards, Protocols, and Related Reading

3.1 Requirements

- **Workstations** running Windows 2000/XP, 2003, Vista/7/8, 2008, MAC OS9 or later, Linux, UNIX or other platforms are compatible with **TCP/IP** protocols.
- **Workstation** is installed with **Ethernet NIC** (Network Interface Card)
- **Serial Port** connect (Terminal)
 - The above PC with COM Port (DB9 / RS232) or USB-to-RS232 converter
- Ethernet Port connection
 - Network cables -- Use standard network (UTP) cables with RJ45 connectors.
- The above Workstation is installed with **Web browser** and **JAVA runtime environment** plug-in



Note

It is recommended to use Internet Explore 8.0 or above to access LRP Managed Switch.

3.2 Management Access Overview

The LRP Managed Switch gives you the flexibility to access and manage it using any or all of the following methods:

- An administration **console**
- **Web browser** interface
- An external **SNMP-based network management application**

The administration console and Web browser interface support are embedded in the LRP Managed Switch software and are available for immediate use. Each of these management methods has their own advantages. Table 3-1 compares the three management methods.

| Method | Advantages | Disadvantages |
|--------------------|---|---|
| Console | <ul style="list-style-type: none"> • No IP address or subnet needed • Text-based • Telnet functionality and HyperTerminal built into Windows 95/98/NT/2000/ME/XP operating systems • Secure | <ul style="list-style-type: none"> • Must be near the switch or use dial-up connection • Not convenient for remote users • Modem connection may prove to be unreliable or slow |
| Web Browser | <ul style="list-style-type: none"> • Ideal for configuring the switch remotely • Compatible with all popular browsers • Can be accessed from any location • Most visually appealing | <ul style="list-style-type: none"> • Security can be compromised (hackers need only know the IP address and subnet mask) • May encounter lag times on poor connections |
| SNMP Agent | <ul style="list-style-type: none"> • Communicates with switch functions at the MIB level • Based on open standards | <ul style="list-style-type: none"> • Requires SNMP manager software • Least visually appealing of all three methods • Some settings require calculations • Security can be compromised (hackers only need to know the community name) |

Table 3-1 Comparison of Management Methods

3.3 Administration Console

The administration console is an internal, character-oriented, and command line user interface for performing system administration such as displaying statistics or changing option settings. Using this method, you can view the administration console from a terminal, personal computer, Apple Macintosh, or workstation connected to the LRP Managed Switch's console port.

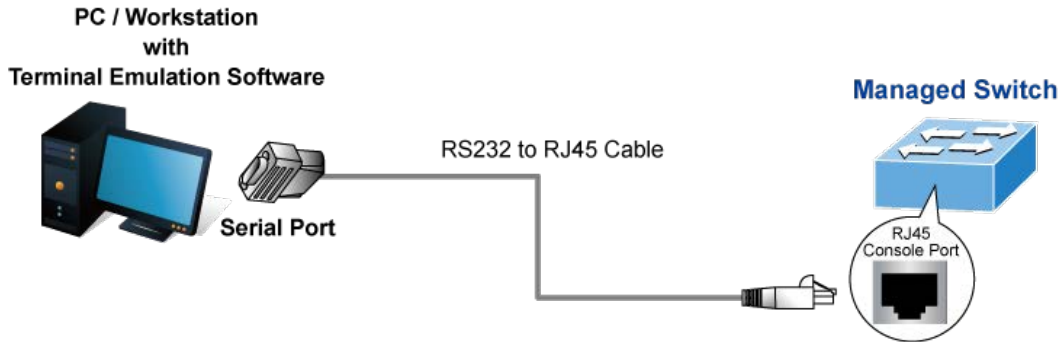

Figure 3-1-1: Console Management

Direct Access

Direct access to the administration console is achieved by directly connecting a terminal or a PC equipped with a terminal-emulation program (such as **HyperTerminal**) to the LRP Managed Switch console (serial) port. When using this management method, a **straight RS232 to RJ45 cable** is required to connect the switch to the PC. After making this connection, configure the terminal-emulation program to use the following parameters:

The default parameters are:

- 115200 bps
- 8 data bits
- No parity
- 1 stop bit

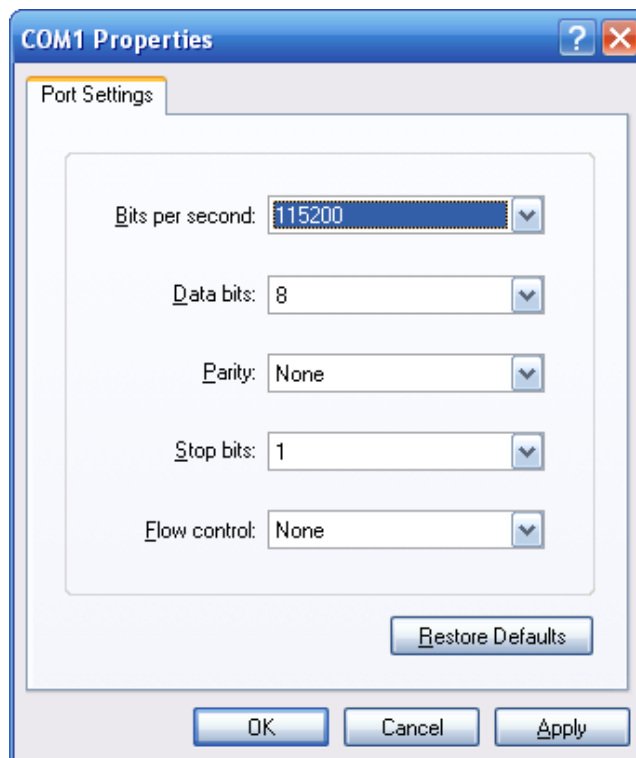

Figure 3-1-2: Terminal Parameter Settings

You can change these settings, if desired, after you log on. This management method is often preferred because you can remain connected and monitor the system during system reboots. Also, certain error messages are sent to the serial port,

regardless of the interface through which the associated action was initiated. A Macintosh or PC attachment can use any terminal-emulation program for connecting to the terminal serial port. A workstation attachment under UNIX can use an emulator such as TIP.

3.4 Web Management

The LRP Managed Switch offers management features that allow users to manage the LRP Managed Switch from anywhere on the network through a standard browser such as Microsoft Internet Explorer. After you set up your IP address for the switch, you can access the LRP Managed Switch's Web interface applications directly in your Web browser by entering the IP address of the LRP Managed Switch.

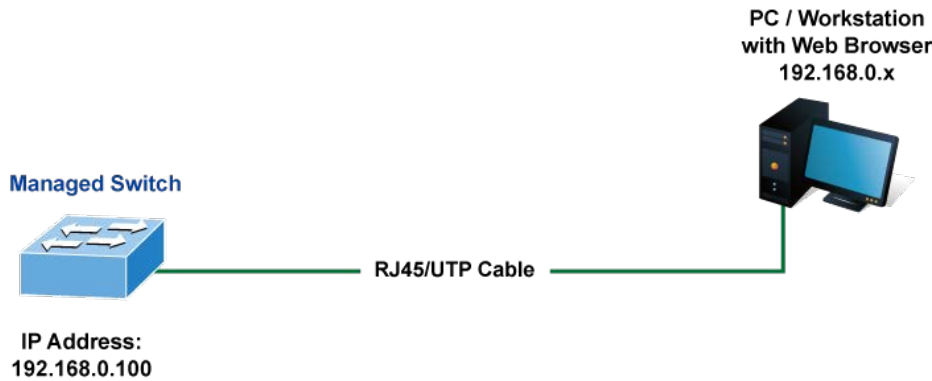

Figure 3-1-3 Web Management

You can then use your Web browser to list and manage the LRP Managed Switch configuration parameters from one central location, just as if you were directly connected to the LRP Managed Switch's console port. Web Management requires either **Microsoft Internet Explorer 8.0** or later, **Google Chrome**, **Safari** or **Mozilla Firefox 1.5**, or later.

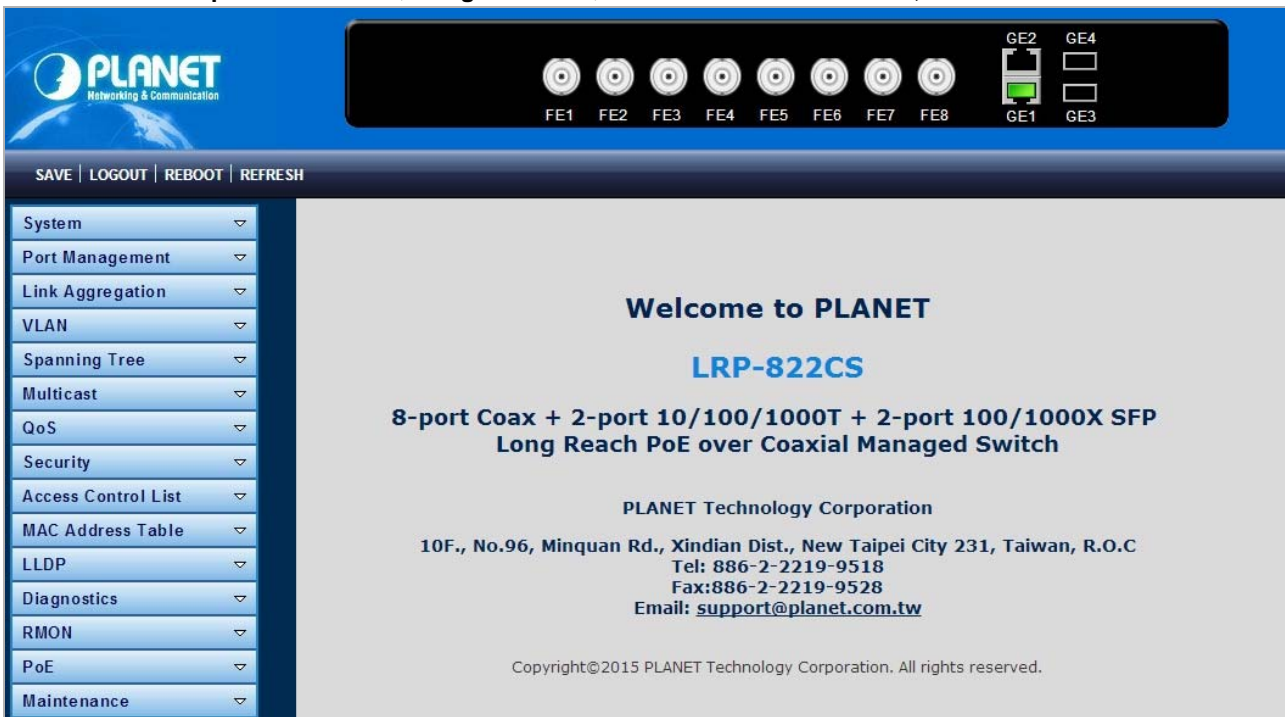

Figure 3-1-4 Web Main Screen of LRP Managed Switch

3.5 SNMP-based Network Management

You can use an external SNMP-based application to configure and manage the LRP Managed Switch, such as SNMP Network Manager, HP Openview Network Node Management (NNM) or What's Up Gold. This management method requires the SNMP agent on the switch and the SNMP Network Management Station to use the **same community string**. This management method, in fact, uses two community strings: the **get community** string and the **set community** string. If the SNMP Network management Station only knows the set community string, it can read and write to the MIBs. However, if it only knows the get community string, it can only read MIBs. The default gets and sets community strings for the LRP Managed Switch are public.

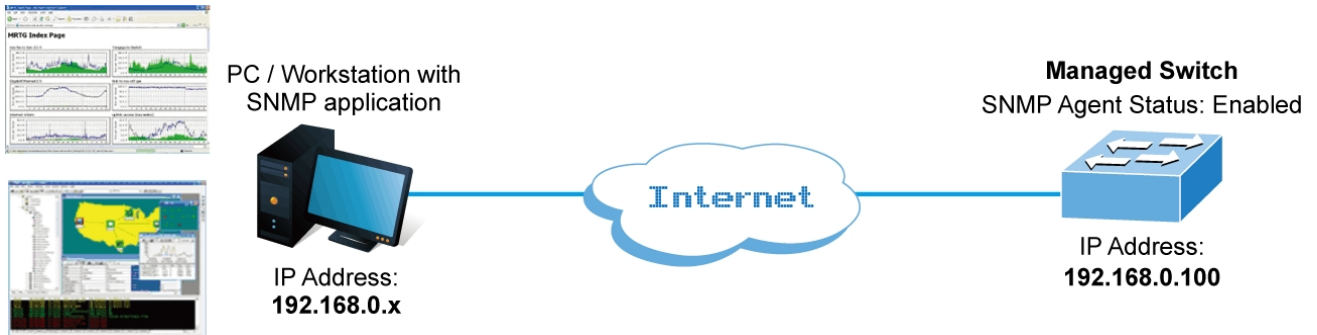

Figure 3-1-5 SNMP management

3.6 PLANET Smart Discovery Utility

For easily listing the LRP Managed Switch in your Ethernet environment, the Planet Smart Discovery Utility from user's manual CD-ROM is an ideal solution. The following installation instructions are to guide you to running the Planet Smart Discovery Utility.

1. Deposit the Planet Smart Discovery Utility in administrator PC.
2. Run this utility as the following screen appears.

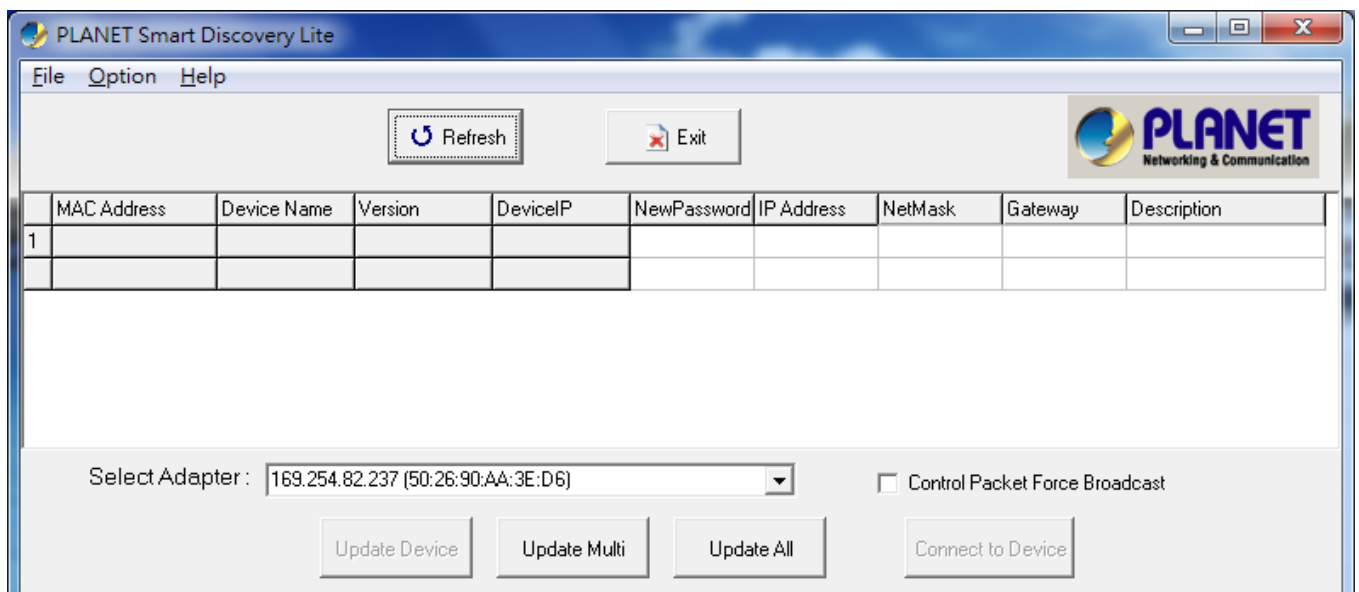

Figure 3-1-6: Planet Smart Discovery Utility Screen



If there are two LAN cards or above in the same administrator PC, choose a different LAN card by using the **“Select Adapter”** tool.

3. Press the **“Refresh”** button for the currently connected devices in the discovery list as the screen shows below:

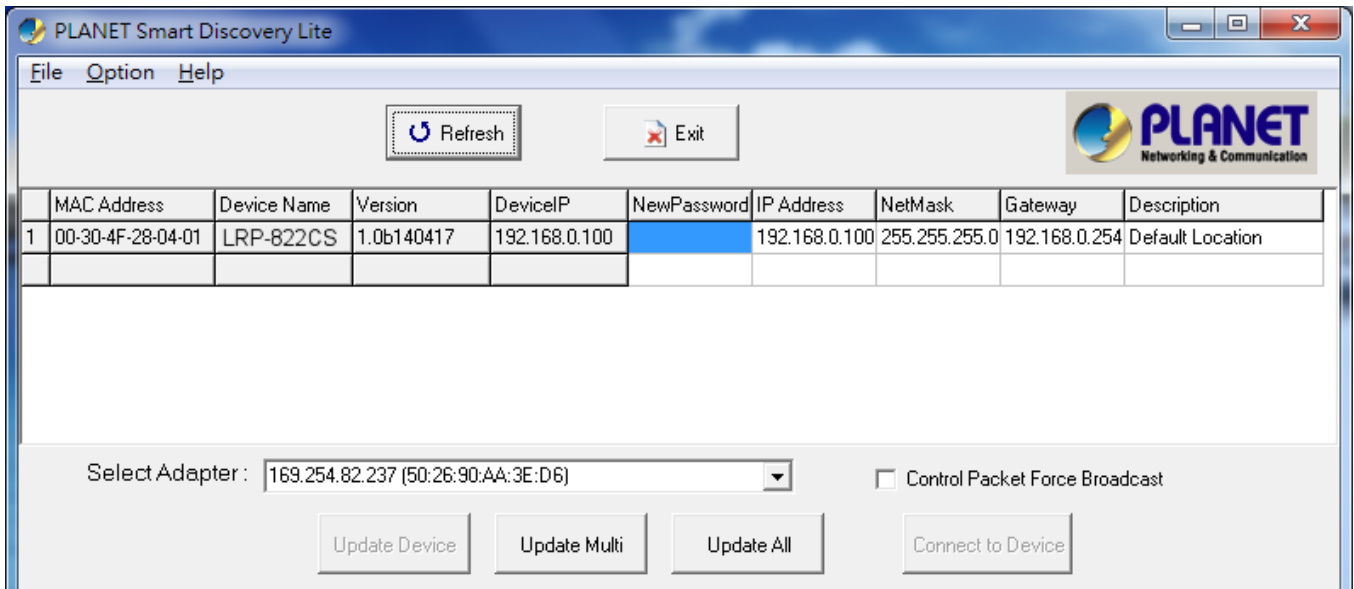

Figure 3-1-7: Planet Smart Discovery Utility Screen

1. This utility shows all necessary information from the devices, such as MAC Address, Device Name, firmware version and Device IP Subnet address. It can also assign new password, IP subnet address and description to the devices.
2. After setup is completed, press the **“Update Device”**, **“Update Multi”** or **“Update All”** button to take effect. The meaning of the 3 buttons above are shown below:
 - **Update Device:** use the current setting on one single device.
 - **Update Multi:** use the current setting on multi-devices.
 - **Update All:** use the current setting on whole devices in the list.

The same functions mentioned above also can be found in **“Option”** tools bar.
3. To click the **“Control Packet Force Broadcast”** function, it allows you to assign a new setting value to the Web Smart Switch under a different IP subnet address.
4. Press the **“Connect to Device”** button and the Web login screen appears in [Figure 3-1-4](#).
5. Press the **“Exit”** button to shut down the Planet Smart Discovery Utility.

4. WEB CONFIGURATION

This section introduces the configuration and functions of the Web-based management.

About Web-based Management

The LRP Managed Switch offers management features that allow users to manage the LRP Managed Switch from anywhere on the network through a standard browser such as Microsoft Internet Explorer.

The Web-based Management supports Internet Explorer 8.0. It is based on Java Applets with an aim to reduce network bandwidth consumption, enhance access speed and present an easy viewing screen.



By default, IE8.0 or later version does not allow Java Applets to open sockets. The user has to explicitly modify the browser setting to enable Java Applets to use network ports.

The LRP Managed Switch can be configured through an Ethernet connection, making sure the manager PC must be set on the same IP subnet address as the LRP Managed Switch.

For example, the default IP address of the LRP Managed Switch is **192.168.0.100**, then the manager PC should be set at **192.168.0.x** (where x is a number between 1 and 254, except 100), and the default subnet mask is 255.255.255.0.

If you have changed the default IP address of the LRP Managed Switch to 192.168.1.1 with subnet mask 255.255.255.0 via console, then the manager PC should be set at 192.168.1.x (where x is a number between 2 and 254) to do the relative configuration on manager PC.

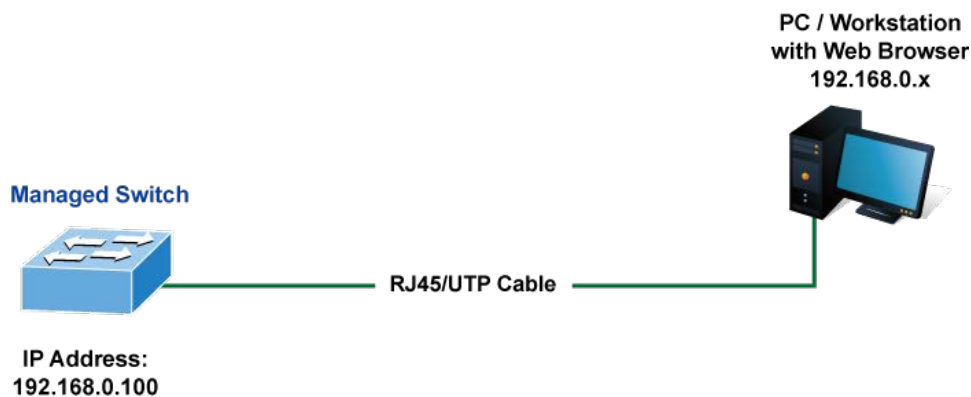

Figure 4-1-1 Web Management

■ Logging on the switch

1. Use Internet Explorer 8.0 or above Web browser. Enter the factory-default IP address to access the Web interface. The factory-default IP address is as follows:

<http://192.168.0.100>

- When the following login screen appears, please enter the default username "admin" with password "admin" (or the username/password you have changed via console) to login the main screen of LRP Managed Switch. The login screen in Figure 4-1-2 appears.

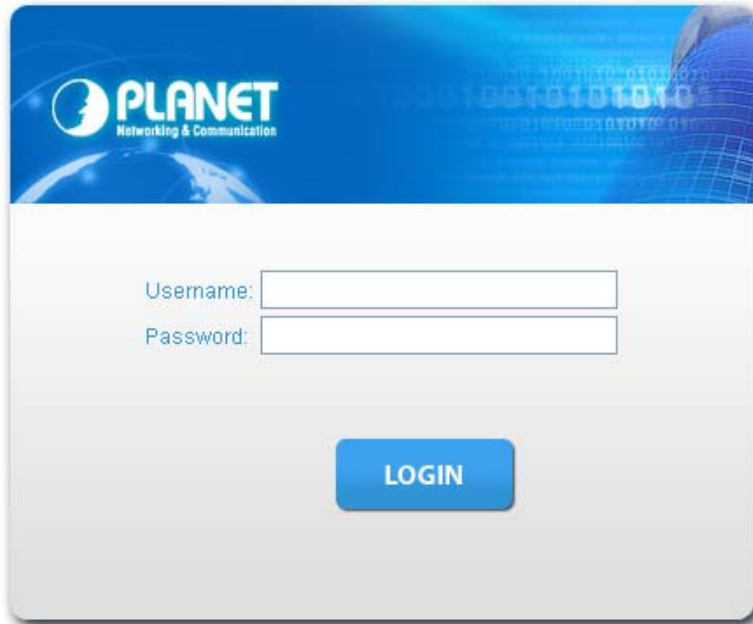

Figure 4-1-2 Login screen

Default User Name: **admin**

Default Password: **admin**

After entering the username and password, the main screen appears as Figure 4-1-3.



Figure 4-1-3 Default Main Page

Now, you can use the Web management interface to continue the switch management or manage the LRP Managed Switch by Web interface. The Switch Menu on the left of the web page lets you access all the commands and statistics the LRP Managed Switch provides.



Note

-
- It is recommended to use Internet Explore 8.0 or above to access LRP Managed Switch.
 - The changed IP address takes effect immediately after clicking on the **Save** button. You need to use the new IP address to access the Web interface.
-



Note

-
- For security reason, please change and memorize the new password after this first setup.
 - Only accept command in lowercase letter under Web interface.
-

4.1 Main Web Page

The LRP Managed Switch provides a Web-based browser interface for configuring and managing it. This interface allows you to access the LRP Managed Switch using the Web browser of your choice. This chapter describes how to use the LRP Managed Switch's Web browser interface to configure and manage it.

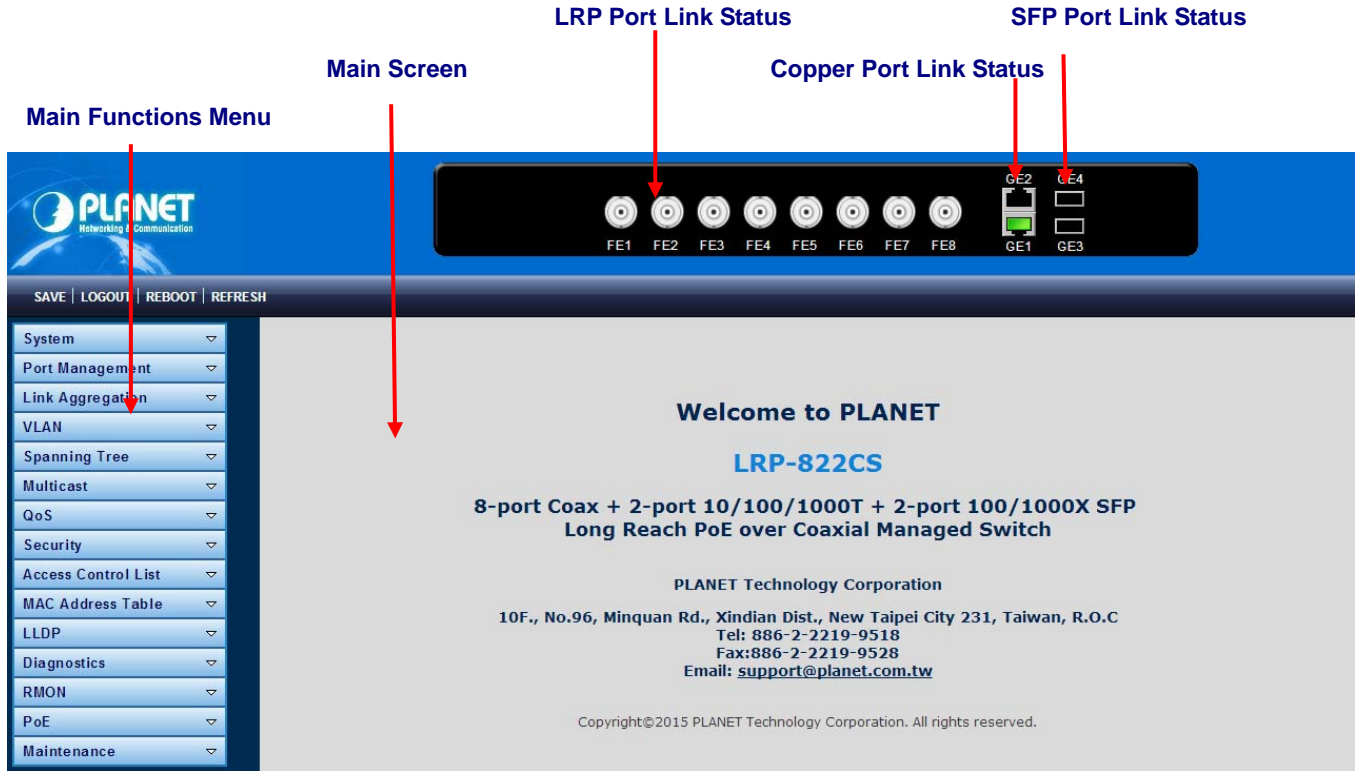

Figure 4-1-4 Main Page

Panel Display

The Web agent displays an image of the LRP Managed Switch's ports. The Mode can be set to display different information for the ports, including Link up or Link down. Clicking on the image of a port opens the **Port Statistics** page.

The port states are illustrated as follows:

| State | Disabled | Down | Link |
|------------|----------|------|------|
| LRP Ports | | | |
| RJ45 Ports | | | |
| SFP Ports | | | |

Main Menu

Using the onboard Web agent, you can define system parameters, manage and control the LRP Managed Switch, and all its ports, or monitor network conditions. Via the Web-Management, the administrator can set up the LRP Managed Switch by selecting the functions those listed in the Main Function. The screen in [Figure 4-1-5](#) appears.

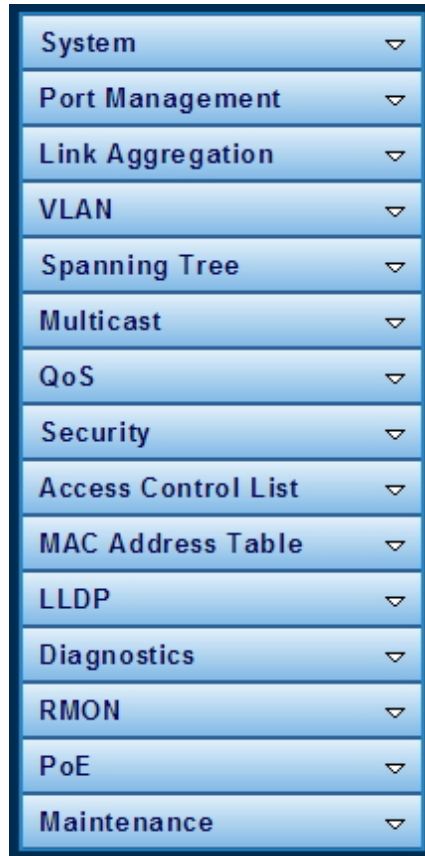

Figure 4-1-5 LRP Managed Switch Main Functions Menu

Buttons



: Click to save changes or reset to default.



: Click to logout the LRP Managed Switch.



: Click to reboot the LRP Managed Switch.



: Click to refresh the page.

4.1.1 Save Button

This save button allows save the running / startup / backup configuration or reset switch in default parameter. The screen in [Figure 4-1-6](#) appears.

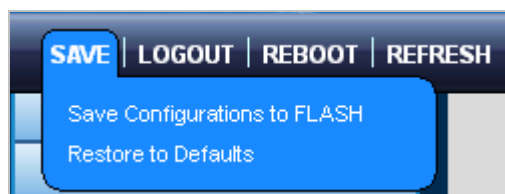

Figure 4-1-6 Save Button Screenshot

The page includes the following fields:

| Object | Description |
|--|---|
| <ul style="list-style-type: none"> • Save Configuration to FLASH | Click to save the configuration. For more detailed information, please refer to chapter 4.1.2 |
| <ul style="list-style-type: none"> • Restore to Default | Click to reset switch in default parameter. For more detailed information, please refer to chapter 4.15.1 |

4.1.2 Configuration Manager

The system file folder contains configuration settings. The screen in [Figure 4-1-7](#) appears.

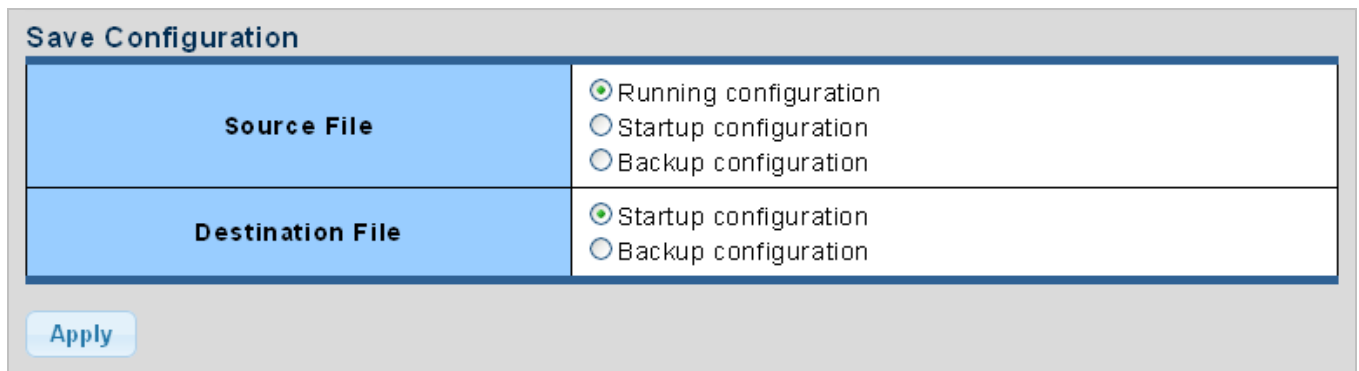



Figure 4-1-7 Save Button Screenshot

The page includes the following fields:

| Object | Description |
|--|---|
| <ul style="list-style-type: none"> • Running Configuration | Refers to the running configuration sequence use in the switch. In switch, the running configuration file stores in the RAM. In the current version, the running configuration sequence running-config can be saved from the RAM to FLASH by saving “ Source File = Running Configuration ” to “ Destination File = Startup Configuration ”, so that the running configuration sequence becomes the startup configuration file, which is called configuration save. To prevent illicit file upload and easier configuration, switch mandates the name of running configuration file to be running-config. |
| <ul style="list-style-type: none"> • Startup Configuration | Refers to the configuration sequence used in switch startup. Startup configuration file stores in nonvolatile storage, corresponding to the so-called configuration save. If the device supports multi-config file, name the configuration file to be .cfg file, the default is startup.cfg. If the device does not support multi-config file, mandates the name of startup configuration file to be startup-config. |
| <ul style="list-style-type: none"> • Backup Configuration | The backup configuration is empty in FLASH; please save the backup configuration first by “ Maintenance > Backup Manager ”. |

Buttons

: Click to save configuration.

4.1.2.1 Saving Configuration

In the LRP Managed Switch, the running configuration file stores in the RAM. In the current version, the running configuration sequence of running-config can be saved from the RAM to FLASH by "Save Configurations to FLASH" function, so that the running configuration sequence becomes the startup configuration file, which is called configuration save.

To save all applied changes and set the current configuration as a startup configuration. The startup-configuration file will be loaded automatically across a system reboot.

1. Click "Save > Save Configurations to FLASH" to login the "Configuration Manager" page.



2. Select "Source File = Running Configuration" and "Destination File = Startup Configuration".

| Save Configuration | |
|-------------------------|---|
| Source File | <input checked="" type="radio"/> Running configuration <input type="radio"/> Startup configuration <input type="radio"/> Backup configuration |
| Destination File | <input checked="" type="radio"/> Startup configuration <input type="radio"/> Backup configuration |



3. Press the "Apply" button to save running configuration to start up configuration.

4.2 System

Use the System menu items to display and configure basic administrative details of the LRP Managed Switch. Under System the following topics are provided to configure and view the system information. This section has the following items:

- **System Information** The switch system information is provided here.
- **IP Configurations** Configure the switch-managed IP information on this page.
- **IPv6 Configuration** Configure the switch-managed IPv6 information on this page.
- **User Configuration** Configure new user name and password on this page.
- **Time Settings** Configure SNTP on this page.
- **Log Management** The switch log information is provided here.
- **SNMP Management** Configure SNMP on this page.

4.2.1 System Information

The System Info page provides information for the current device information. System Info page helps a switch administrator to identify the hardware MAC address, software version and system uptime. The screens in [Figure 4-2-1](#) & [Figure 4-2-2](#) appear.



| System Information | |
|--------------------|---------------------------------------|
| Information Name | Information Value |
| System Name | Edit LRP-822CS |
| System Location | Edit Default Location |
| System Contact | Edit Default Contact |
| MAC Address | 00:30:4F:00:00:00 |
| IP Address | 192.168.0.100 |
| Subnet Mask | 255.255.255.0 |
| Gateway | 192.168.0.254 |
| Loader Version | 2011.12.46351 |
| Loader Date | Apr 16 2014 - 14:51:06 |
| Firmware Version | 1.0b150417 |
| Firmware Date | Wed May 7 15:41:06 UZT 2015 |
| System Object ID | 1.3.6.1.4.1.10456.1.1509 |
| System Up Time | 0 days, 2 hours, 6 mins, 32 secs |
| PCB/HW Version | V1 |

Figure 4-2-1 System Information Page Screenshot

The page includes the following fields:

| Object | Description |
|---------------------------|---|
| • System Name | Display the current system name |
| • System Location | Display the current system location |
| • System Contact | Display the current system contact |
| • MAC Address | The MAC address of this LRP Managed Switch. |
| • IP Address | The IP address of this LRP Managed Switch. |
| • Subnet Mask | The subnet mask of this LRP Managed Switch. |
| • Gateway | The gateway of this LRP Managed Switch. |
| • Loader Version | The loader version of this LRP Managed Switch. |
| • Loader Date | The loader date of this LRP Managed Switch. |
| • Firmware Version | The firmware version of this LRP Managed Switch. |
| • Firmware Date | The firmware date of this LRP Managed Switch. |
| • System Object ID | The system object ID of the LRP Managed Switch. |
| • System Up Time | The period of time the device has been operational. |
| • PCN/HW Version | The hardware version of this LRP Managed Switch. |

Buttons

: Click to edit parameter.

4.2.2 IP Configurations

The IP Configuration includes the IP Address, Subnet Mask and Gateway. The configured column is used to view or change the IP configuration. Fill out the IP Address, Subnet Mask and Gateway for the device. The screens in [Figure 4-2-2](#) & [Figure 4-2-3](#) appear.

IP Address Setting

| | |
|---------------------|--|
| Mode | <input checked="" type="radio"/> Static <input type="radio"/> DHCP |
| IP Address | <input type="text" value="192.168.1.1"/> |
| Subnet Mask | <input type="text" value="255.255.255.0"/> |
| Gateway | <input type="text" value="192.168.1.254"/> |
| DNS Server 1 | <input type="text" value="168.95.1.1"/> |
| DNS Server 2 | <input type="text" value="168.95.192.1"/> |



Figure 4-2-2 IP Address Setting Page Screenshot

The page includes the following fields:

| Object | Description |
|---|---|
| <ul style="list-style-type: none"> • Mode | <p>Indicates the IP address mode operation. Possible modes are:</p> <p>Static: Enable NTP mode operation.</p> <p>When enabling NTP mode operation, the agent forwards and transfers NTP messages between the clients and the server when they are not on the same subnet domain.</p> <p>DHCP: Enable DHCP client mode operation.</p> <p>Enable the DHCP client by checking this box. If DHCP fails and the configured IP address is zero, DHCP will retry. If DHCP fails and the configured IP address is non-zero, DHCP will stop and the configured IP settings will be used. The DHCP client will announce the configured System Name as hostname to provide DNS lookup.</p> |
| <ul style="list-style-type: none"> • IP Address | Provide the IP address of this switch in dotted decimal notation. |
| <ul style="list-style-type: none"> • Subnet Mask | Provide the subnet mask of this switch in dotted decimal notation. |
| <ul style="list-style-type: none"> • Gateway | Provide the IP address of the router in dotted decimal notation. |
| <ul style="list-style-type: none"> • DNS Server 1/2 | Provide the IP address of the DNS Server in dotted decimal notation. |

Buttons

Apply : Click to apply changes.

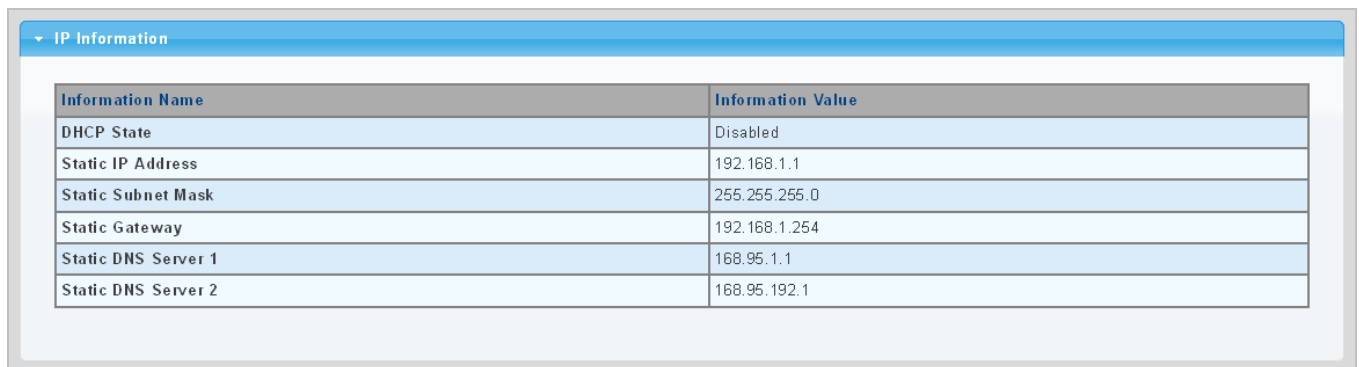

Figure 4-2-3 IP Information Page Screenshot

The page includes the following fields:

| Object | Description |
|---|----------------------------------|
| <ul style="list-style-type: none"> • DHCP State | Display the current DHCP state. |
| <ul style="list-style-type: none"> • IP Address | Display the current IP address. |
| <ul style="list-style-type: none"> • Subnet Mask | Display the current subnet mask. |
| <ul style="list-style-type: none"> • Gateway | Display the current gateway. |
| <ul style="list-style-type: none"> • DNS Server 1/2 | Display the current DNS server. |

4.2.3 IPv6 Configuration

The IPv6 Configuration includes Auto Configuration, IPv6 Address and Gateway. The configured column is used to view or change the IPv6 configuration. Fill out the Auto Configuration, IPv6 Address and Gateway for the device. The screens in [Figure 4-2-4](#) & [Figure 4-2-5](#) appear.

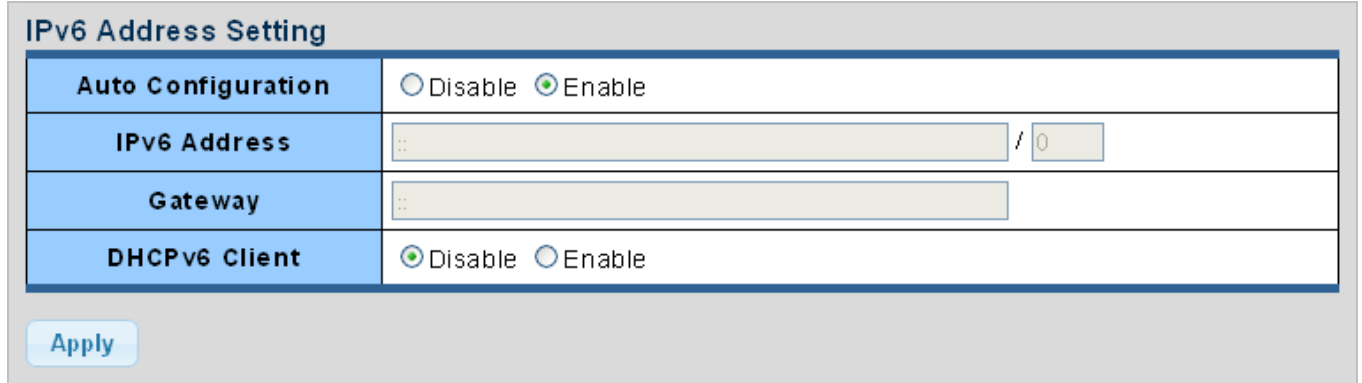

Figure 4-2-4 IPv6 Address Setting Page Screenshot

The page includes the following fields:

| Object | Description |
|---|---|
| <ul style="list-style-type: none"> • Auto Configuration | <p>Enable IPv6 auto-configuration by checking this box.</p> <p>If it fails, the configured IPv6 address is zero. The router may delay responding to a router solicitation for a few seconds; the total time needed to complete auto-configuration can be significantly longer.</p> |
| <ul style="list-style-type: none"> • IPv6 Address | <p>Provide the IPv6 address of this switch.</p> <p>IPv6 address is in 128-bit records represented as eight fields of up to four hexadecimal digits with a colon separating each field (:). For example, 'fe80::215:c5ff:fe03:4dc7'.</p> <p>The symbol '::' is a special syntax that can be used as a shorthand way of representing multiple 16-bit groups of contiguous zeros; but it can only appear once. It also uses the following legally IPv4 address. For example, ':::192.1.2.34'.</p> <p>Provide the IPv6 Prefix of this switch. The allowed range is 1 through 128.</p> |
| <ul style="list-style-type: none"> • Gateway | <p>Provide the IPv6 gateway address of this switch.</p> |
| <ul style="list-style-type: none"> • DHCPv6 Client | <p>To enable this LRP Managed Switch to accept a configuration from a Dynamic Host Configuration Protocol version 6 (DHCPv6) server. By default, the LRP Managed Switch does not perform DHCPv6 client actions. DHCPv6 clients request the delegation of long-lived prefixes that they can push to individual local hosts.</p> |

Buttons

Apply : Click to apply changes.

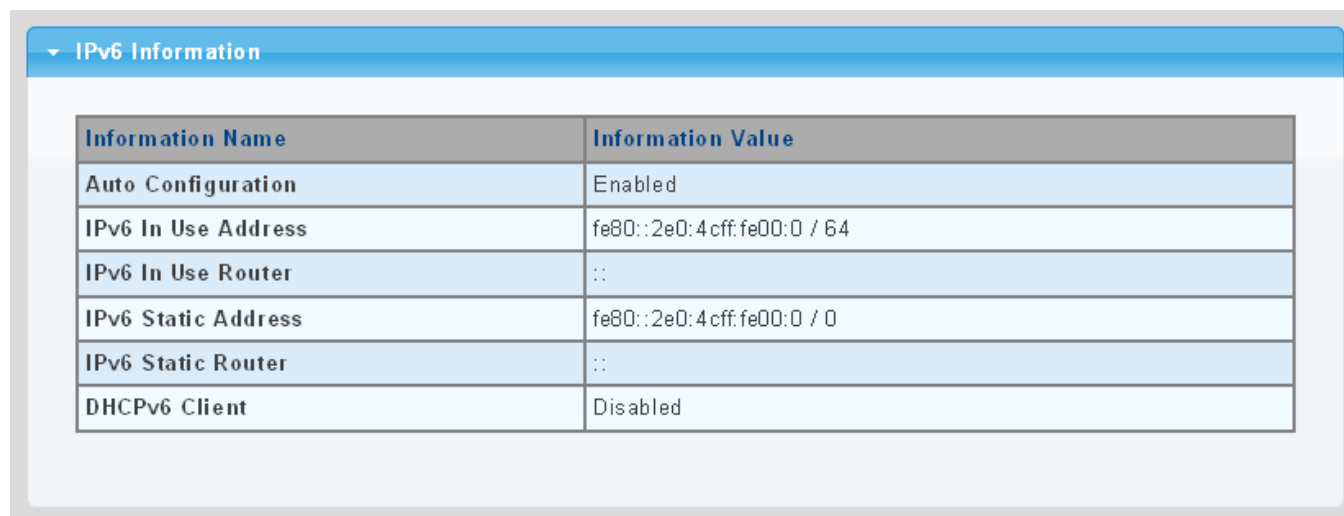

Figure 4-2-5 IPv6 Information Page Screenshot

The page includes the following fields:

| Object | Description |
|------------------------------|--|
| • Auto Configuration | Display the current auto configuration state |
| • IPv6 In Use Address | Display the current IPv6 in-use address |
| • IPv6 In Use Router | Display the current in-use gateway |
| • IPv6 Static Address | Display the current IPv6 static address |
| • IPv6 Static Router | Display the current IPv6 static gateway |
| • DHCPv6 Client | Display the current DHCPv6 client status |

4.2.4 User Configuration

This page provides an overview of the current users and privilege type. Currently the only way to login as another user on the Web server is to close and reopen the browser. After the setup is completed, please press the “**Apply**” button to take effect. Please login Web interface with a new user name and password; the screens in [Figure 4-2-6](#) & [Figure 4-2-7](#) appear.

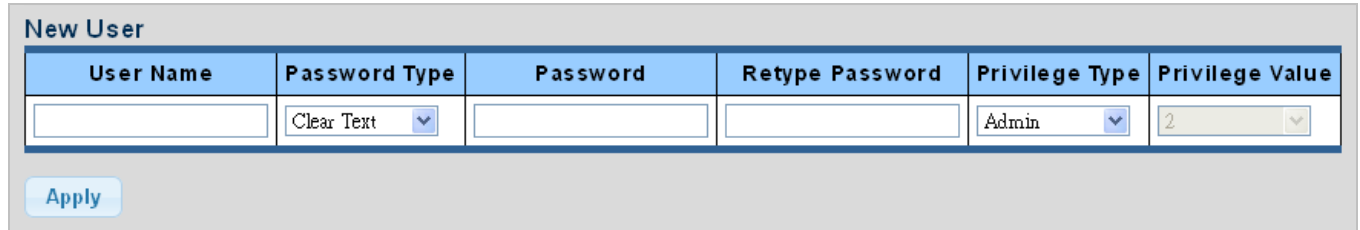

Figure 4-2-6 Local User Information Page Screenshot

The page includes the following fields:

| Object | Description |
|--|--|
| <ul style="list-style-type: none"> • Username | The name identifying the user. Maximum length: 32 characters; Maximum number of users: 8 |
| <ul style="list-style-type: none"> • Password Type | The password type for the user. |
| <ul style="list-style-type: none"> • Password | Enter the user’s new password here. (Range: 0-32 characters plain text, case sensitive) |
| <ul style="list-style-type: none"> • Retype Password | Please enter the user’s new password here again to confirm. |
| <ul style="list-style-type: none"> • Privilege Type | The privilege type for the user. Options: <ul style="list-style-type: none"> • Admin • User • Other |

Buttons

 : Click to apply changes.

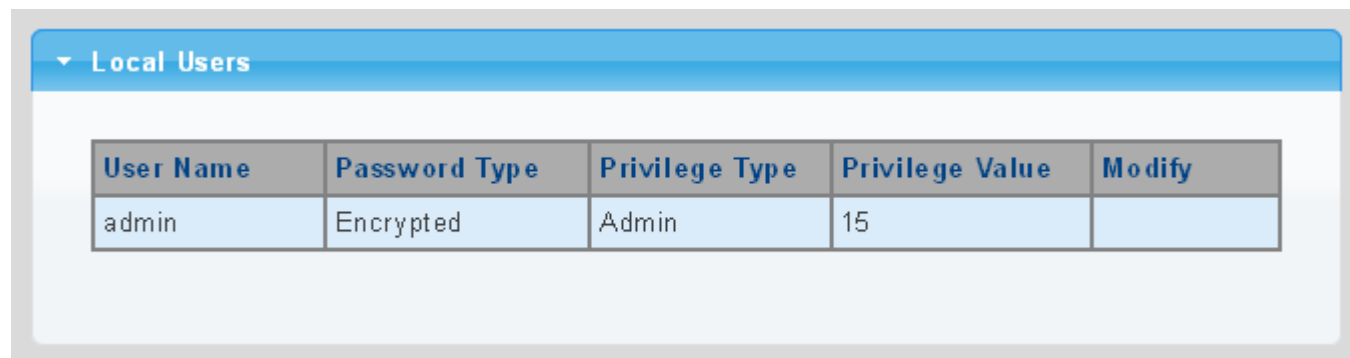

Figure 4-2-7 Local User Page Screenshot

The page includes the following fields:

| Object | Description |
|------------------|---|
| • Username | Display the current username |
| • Password Type | Display the current password type |
| • Privilege Type | Display the current privilege type |
| • Modify | Click to modify the local user entry <input type="button" value="Delete"/> : Delete the current user |

4.2.5 Time Settings

4.2.5.1 System Time

Configure SNTP on this page.

SNTP is an acronym for **Simple Network Time Protocol**, a network protocol for synchronizing the clocks of computer systems. You can specify SNTP Servers and set GMT Time zone. The SNTP Configuration screens in [Figure 4-2-8](#) & [Figure 4-2-9](#) appear.

System Time Setting

| | |
|------------------------------------|--|
| Enable SNTP | <input checked="" type="radio"/> Disable <input type="radio"/> Enable |
| Manual Time | Year <input type="text" value="2000"/> Month <input type="text" value="Jan"/> Day <input type="text" value="1"/> Hours <input type="text" value="0"/> Minutes <input type="text" value="0"/> Seconds <input type="text" value="0"/> |
| Time Zone | <input type="text" value="None"/> |
| Daylight Saving Time | <input type="text" value="Disable"/> |
| Daylight Saving Time Offset | <input type="text" value="60"/> (1 - 1440) Minutes |
| Recurring From | Day <input type="text" value="Sun"/> Week <input type="text" value="1"/> Month <input type="text" value="Jan"/> Hours <input type="text" value="0"/> Minutes <input type="text" value="0"/> |
| Recurring To | Day <input type="text" value="Sun"/> Week <input type="text" value="1"/> Month <input type="text" value="Jan"/> Hours <input type="text" value="0"/> Minutes <input type="text" value="0"/> |
| Non-recurring From | Year <input type="text" value="2000"/> Month <input type="text" value="Jan"/> Date <input type="text" value="1"/> Hours <input type="text" value="0"/> Minutes <input type="text" value="0"/> |
| Non-recurring To | Year <input type="text" value="2000"/> Month <input type="text" value="Jan"/> Date <input type="text" value="1"/> Hours <input type="text" value="0"/> Minutes <input type="text" value="0"/> |

Figure 4-2-8 SNTP Setup Page Screenshot

The page includes the following fields:

| Object | Description |
|---------------|--|
| • Enable SNTP | Enabled: Enable SNTP mode operation. When enabling SNTP mode operation, the agent forwards and transfers |

| | |
|--|---|
| | <p>SNTP messages between the clients and the server when they are not on the same subnet domain.</p> <p>Disabled: Disable SNTP mode operation.</p> |
| <ul style="list-style-type: none"> • Manual Time | <p>To set time manually.</p> <ul style="list-style-type: none"> ■ Year - Select the starting Year. ■ Month - Select the starting month. ■ Day - Select the starting day. ■ Hours - Select the starting hour. ■ Minutes - Select the starting minute. ■ Seconds - Select the starting seconds. |
| <ul style="list-style-type: none"> • Time Zone | <p>Allows to select the time zone according to the current location of switch.</p> |
| <ul style="list-style-type: none"> • Daylight Saving Time | <p>This is used to set the clock forward or backward according to the configurations set below for a defined Daylight Saving Time duration. Select 'Disable' to disable the Daylight Saving Time configuration. Select 'Recurring' and configure the Daylight Saving Time duration to repeat the configuration every year. Select 'Non-Recurring' and configure the Daylight Saving Time duration for single time configuration. (Default : Disabled).</p> |
| <ul style="list-style-type: none"> • Daylight Saving Time Offset | <p>Enter the number of minutes to add during Daylight Saving Time. (Range: 1 to 1440)</p> |
| <ul style="list-style-type: none"> • Recurring From | <ul style="list-style-type: none"> • Week - Select the starting week number. • Day - Select the starting day. • Month - Select the starting month. • Hours - Select the starting hour. • Minutes - Select the starting minute. |
| <ul style="list-style-type: none"> • Recurring To | <ul style="list-style-type: none"> • Week - Select the starting week number. • Day - Select the starting day. • Month - Select the starting month. • Hours - Select the starting hour. • Minutes - Select the starting minute. |
| <ul style="list-style-type: none"> • Non-recurring From | <ul style="list-style-type: none"> • Week - Select the starting week number. • Day - Select the starting day. • Month - Select the starting month. • Hours - Select the starting hour. • Minutes - Select the starting minute. |
| <ul style="list-style-type: none"> • Non-recurring To | <ul style="list-style-type: none"> • Week - Select the starting week number. • Day - Select the starting day. • Month - Select the starting month. • Hours - Select the starting hour. • Minutes - Select the starting minute. |

Buttons

Apply : Click to apply changes.

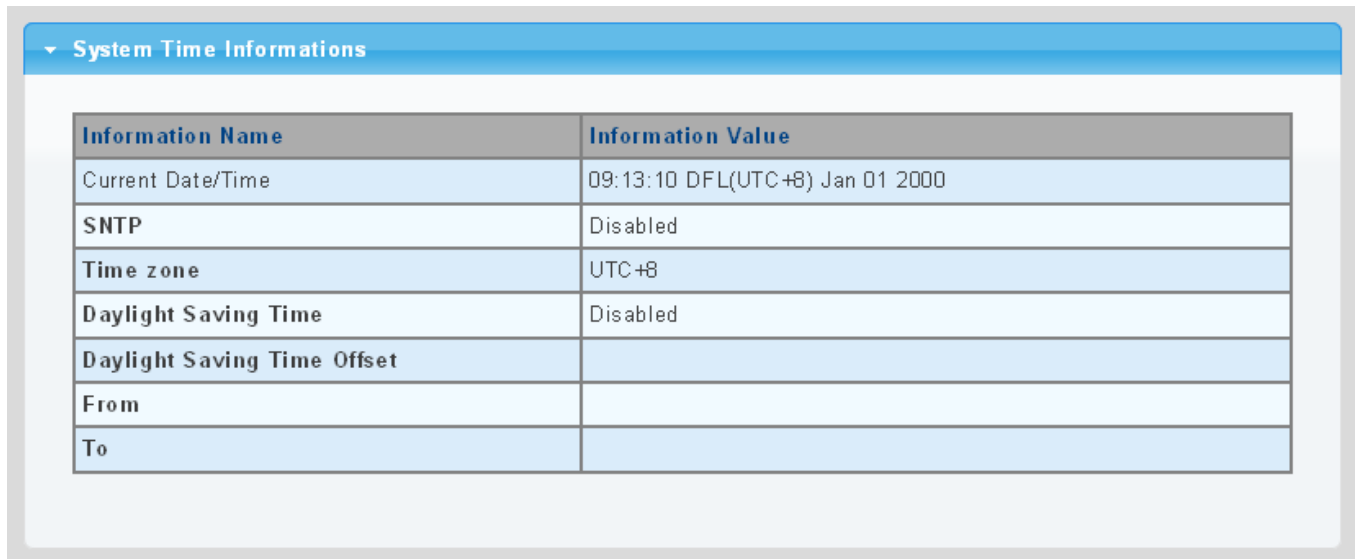

Figure 4-2-9 Time Information Page Screenshot

The page includes the following fields:

| Object | Description |
|--------------------------------------|---|
| • Current Data/Time | Display the current data/time |
| • SNTP | Display the current SNTP state |
| • Time Zone | Display the current time zone |
| • Daylight Saving Time | Display the current daylight saving time state |
| • Daylight Saving Time Offset | Display the current daylight saving time offset state |
| • From | Display the current daylight saving time from |
| • To | Display the current daylight saving time to |

4.2.5.2 SNTP Server Settings

The SNTP Server Configuration screens in [Figure 4-2-10](#) & [Figure 4-2-11](#) appear.

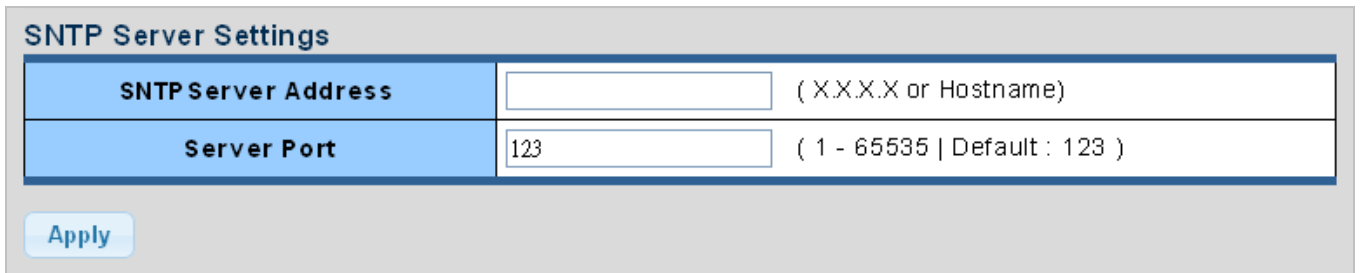

The screenshot shows a configuration form titled "SNTP Server Settings". It contains two input fields: "SNTP Server Address" with a placeholder "(X.X.X.X or Hostname)" and "Server Port" with a value of "123" and a range "(1 - 65535 | Default : 123)". An "Apply" button is located at the bottom left of the form.

Figure 4-2-10 SNTP Setup Page Screenshot

The page includes the following fields:

| Object | Description |
|-----------------------|---|
| • SNTP Server Address | Type the IP address or domain name of the SNTP server |
| • Server Port | Type the port number of the SNTP |

Buttons

: Click to apply changes.

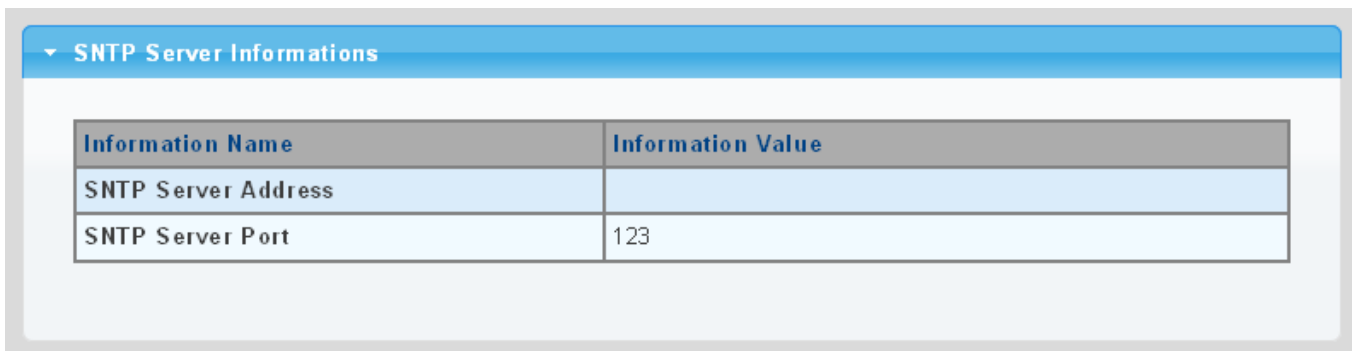

The screenshot shows a summary table under the heading "SNTP Server Informations". The table lists the configuration values for the SNTP server.

| Information Name | Information Value |
|---------------------|-------------------|
| SNTP Server Address | |
| SNTP Server Port | 123 |

Figure 4-2-11 SNTP Server Information Page Screenshot

The page includes the following fields:

| Object | Description |
|-----------------------|---|
| • SNTP Server Address | Display the current SNTP server address |
| • Server Port | Display the current SNTP server port |

4.2.6 Log Management

The LRP Managed Switch log management is provided here. The local logs allow you to configure and limit system messages that are logged to flash or RAM memory. The default is for event levels 0 to 3 to be logged to flash and levels 0 to 6 to be logged to RAM. The following table lists the event levels of the LRP Managed Switch:

| Level | Severity Name | Description |
|-------|----------------------|--|
| 7 | Debug | Debugging messages |
| 6 | Informational | Informational messages only |
| 5 | Notice | Normal but significant condition, such as cold start |
| 4 | Warning | Warning conditions (e.g., return false, unexpected return) |
| 3 | Error | Error conditions (e.g., invalid input, default used) |
| 2 | Critical | Critical conditions (e.g., memory allocation, or free memory error - resource exhausted) |
| 1 | Alert | Immediate action needed |
| 0 | Emergency | System unusable |

4.2.6.1 Local Log

The switch system local log information is provided here. The local Log screens in [Figure 4-2-12](#) & [Figure 4-2-13](#) appear.

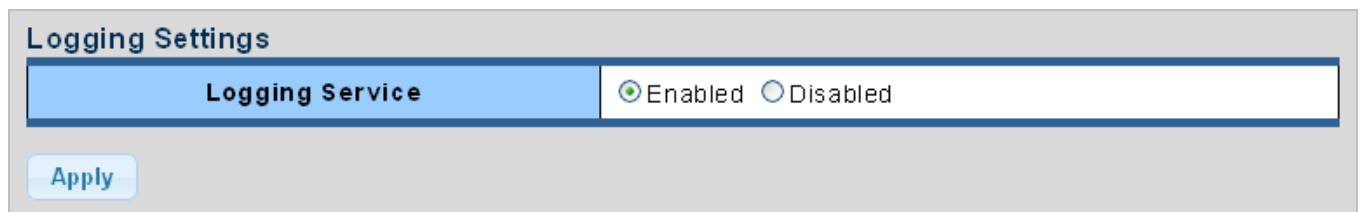

Figure 4-2-12 Logging Settings Page Screenshot

The page includes the following fields:

| Object | Description |
|--|---|
| <ul style="list-style-type: none"> • Logging Service | <p>Enabled: Enable logging service operation.</p> <p>Disabled: Disable logging service operation.</p> |

Buttons

: Click to apply changes.

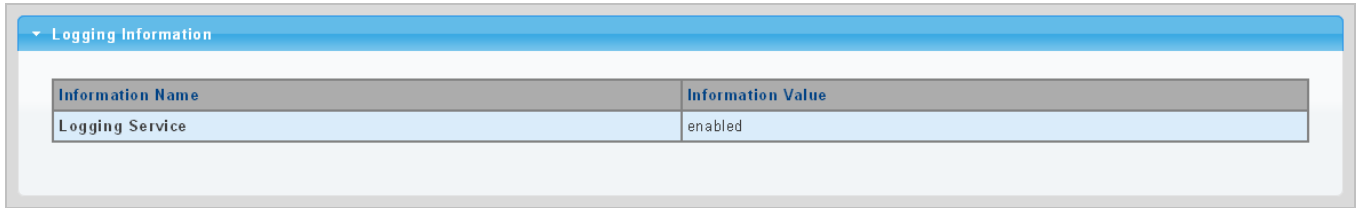

Figure 4-2-13 Logging Information Page Screenshot

The page includes the following fields:

| Object | Description |
|---|--|
| <ul style="list-style-type: none"> Logging Service | Display the current logging service status |

4.2.6.2 Local Log

The switch system local log information is provided here. The local Log screens in [Figure 4-2-14](#) & [Figure 4-2-15](#) appear.

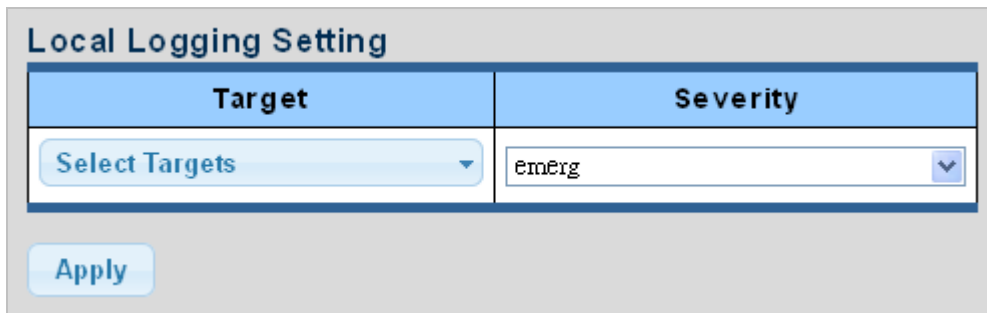



Figure 4-2-14 Local Log Target Setting Page Screenshot

The page includes the following fields:

| Object | Description |
|--|--|
| <ul style="list-style-type: none"> Target | The target of the local log entry. The following target types are supported: <ul style="list-style-type: none"> Buffered: Target the buffer of the local log. File: Target the file of the local log. |
| <ul style="list-style-type: none"> Severity | The severity of the local log entry. The following severity types are supported: <ul style="list-style-type: none"> emerg: Emergency level of the system unstable for local log. alert: Alert level of the immediate action needed for local log. crit: Critical level of the critical conditions for local log. error: Error level of the error conditions for local log. warning: Warning level of the warning conditions for local log. notice: Notice level of the normal but significant conditions for local log. info: Informational level of the informational messages for local log. debug: Debug level of the debugging messages for local log. |

Buttons

: Click to apply changes.

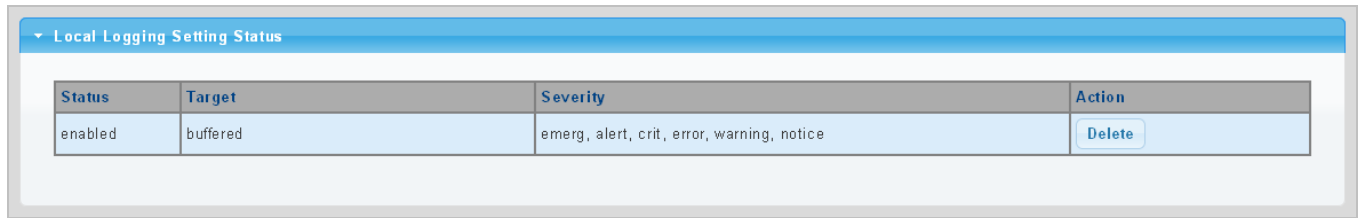



Figure 4-2-15 Local Log Setting Status Page Screenshot

The page includes the following fields:

| Object | Description |
|-------------------|---|
| • Status | Display the current local log state |
| • Target | Display the current local log target |
| • Severity | Display the current local log severity |
| • Action |  : Delete the current status |

4.2.6.3 Remote Syslog

Configure remote syslog on this page. The Remote Syslog page allows you to configure the logging of messages that are sent to syslog servers or other management stations. You can also limit the event messages sent to only those messages below a specified level.

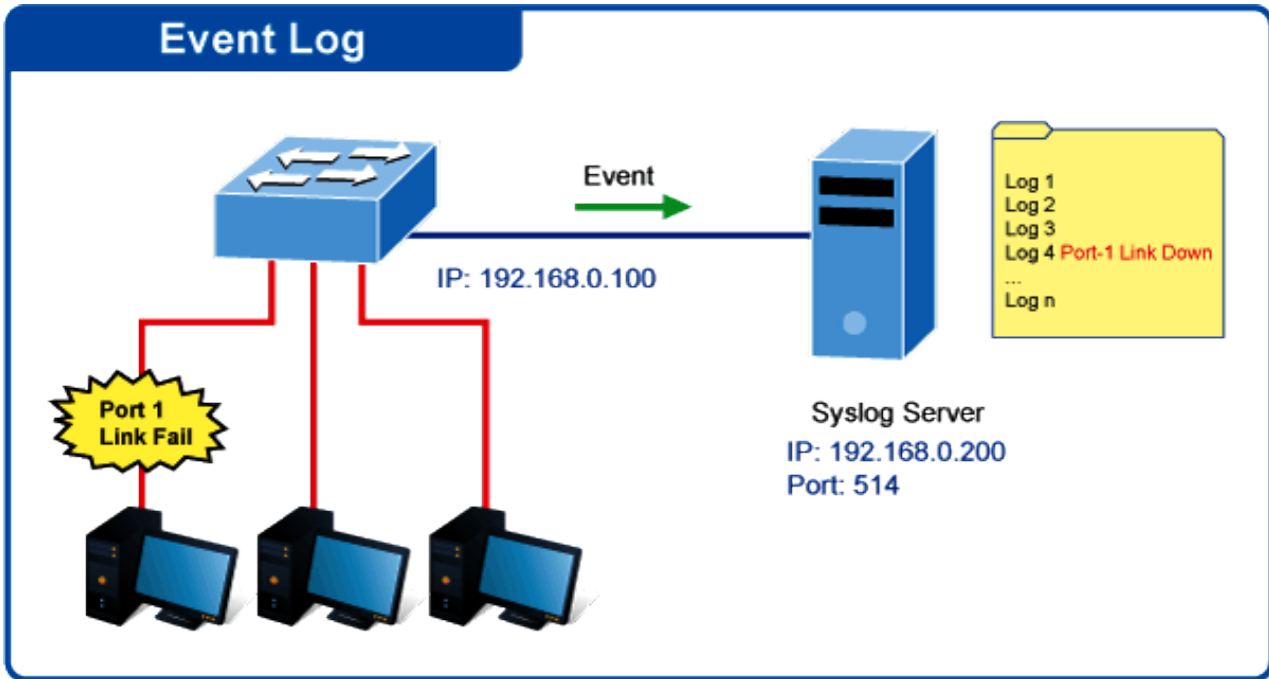

The Remote Syslog screens in [Figure 4-2-16](#) & [Figure 4-2-17](#) appear.

| Remote Logging Setting | | | |
|------------------------|--|------------------------------------|-------------------------------------|
| Server Address | Server Port | Severity | Facility |
| <input type="text"/> | <input type="text" value="514"/> (1-65535) | <input type="text" value="emerg"/> | <input type="text" value="local0"/> |

Figure 4-2-16 Remote Log Target Page Screenshot

The page includes the following fields:

| Object | Description |
|-------------------------|---|
| • Server Address | Provide the remote syslog IP address of this switch. |
| • Server Port | Provide the port number of remote syslog server. Default Port no.: 514 |
| • Severity | The severity of the local log entry. The following severity types are supported: <ul style="list-style-type: none"> ■ emerg: Emergency level of the system unstable for local log. ■ alert: Alert level of the immediate action needed for local log. |

| | |
|-------------------|---|
| | <ul style="list-style-type: none"> ■ crit: Critical level of the critical conditions for local log. ■ error: Error level of the error conditions for local log. ■ warning: Warning level of the warning conditions for local log. ■ notice: Notice level of the normal but significant conditions for local log. ■ info: Informational level of the informational messages for local log. ■ debug: Debug level of the debugging messages for local log. |
| • Facility | Local0~7 : local user 0~7 |

Buttons



 : Click to apply changes.



Figure 4-2-17 Remote Log Setting Status Page Screenshot

The page includes the following fields:

| Object | Description |
|----------------------|--|
| • Status | Display the current remote syslog state |
| • Server Info | Display the current remote syslog server information |
| • Severity | Display the current remote syslog severity |
| • Facility | Display the current remote syslog facility |
| • Action |  : Delete the remote server entry |

4.2.6.4 Log Message

The switch log view is provided here. The Log View screens in [Figure 4-2-18](#), [Figure 4-2-19](#) & [Figure 4-2-20](#) appear.

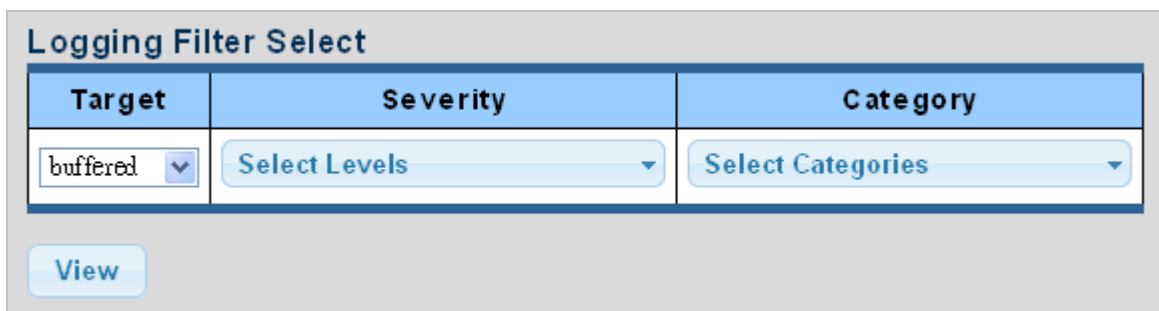

Figure 4-2-18 Log Information Select Page Screenshot

The page includes the following fields:

| Object | Description |
|---|---|
| <ul style="list-style-type: none"> • Target | The target of the log view entry. The following target types are supported: <ul style="list-style-type: none"> ■ Buffered: Target the buffered of the log view. ■ File: Target the file of the log view. |
| <ul style="list-style-type: none"> • Severity | The severity of the log view entry. The following severity types are supported: <ul style="list-style-type: none"> ■ emerg: Emergency level of the system unstable for log view. ■ alert: Alert level of the immediate action needed for log view. ■ crit: Critical level of the critical conditions for log view. ■ error: Error level of the error conditions for log view. ■ warning: Warning level of the warning conditions for log view. ■ notice: Notice level of the normal but significant conditions for log view. ■ info: Informational level of the informational messages for log view. ■ debug: Debug level of the debugging messages for log view. |
| <ul style="list-style-type: none"> • Category | The category of the log view includes: AAA, ACL, CABLE_DIAG, DAI, DHCP_SNOOPING, Dot1X, GVRP, IGMP_SNOOPING, IPSG, L2, LLDP, Mirror, MLD_SNOOPING, Platform, PM, Port, PORT_SECURITY, QoS, Rate, SNMP and STP |

Buttons

 : Click to view log.

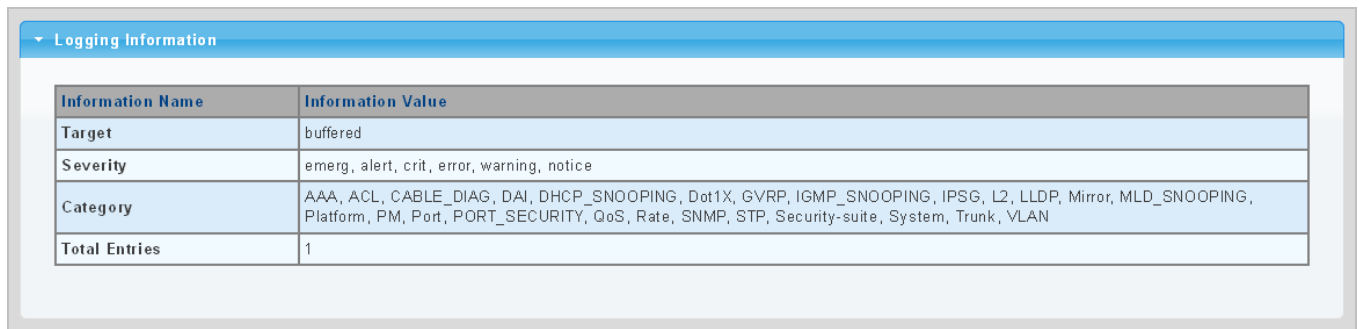

Figure 4-2-19 Logging Information Page Screenshot

The page includes the following fields:

| Object | Description |
|--|----------------------------------|
| <ul style="list-style-type: none"> • Target | Display the current log target |
| <ul style="list-style-type: none"> • Severity | Display the current log severity |
| <ul style="list-style-type: none"> • Category | Display the current log category |
| <ul style="list-style-type: none"> • Total Entries | Display the current log entries |

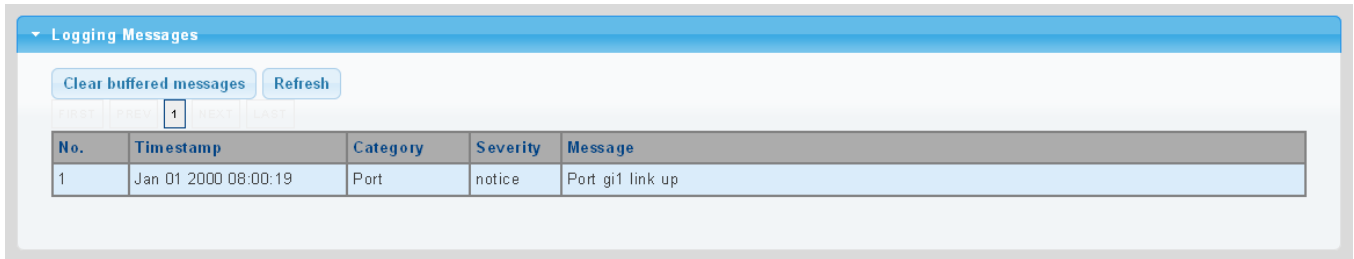

Figure 4-2-20 Logging Messages Page Screenshot

The page includes the following fields:

| Object | Description |
|--------------------|-----------------------------|
| • No. | This is the number for logs |
| • Timestamp | Display the time of log |
| • Category | Display the category type |
| • Severity | Display the severity type |
| • Message | Display the log message |

Buttons

Clear: Click to clear the log.

Refresh: Click to refresh the log.

4.2.7 SNMP Management

4.2.7.1 SNMP Overview

The **Simple Network Management Protocol (SNMP)** is an application layer protocol that facilitates the exchange of management information between network devices. It is part of the **Transmission Control Protocol/Internet Protocol (TCP/IP)** protocol suite. SNMP enables network administrators to manage network performance, find and solve network problems, and plan for network growth.

An SNMP-managed network consists of four components: Network management stations (NMSs), SNMP agent, management information base (MIB) and network-management protocol:

- **Network management stations (NMSs):** Sometimes called consoles, these devices execute management applications that monitor and control network elements. Physically, NMSs are usually engineering workstation-caliber computers with fast CPUs, megapixel color displays, substantial memory, and abundant disk space. At least one NMS must be present in each managed environment.
- **Agents :** Agents are software modules that reside in network elements. They collect and store management information such as the number of error packets received by a network element.
- **Management information base (MIB) :** A MIB is a collection of managed objects residing in a virtual information store. Collections of related managed objects are defined in specific MIB modules.
- **Network-management protocol :** A management protocol is used to convey management information between agents and NMSs. SNMP is the Internet community's de facto standard management protocol.

SNMP Operations

SNMP itself is a simple request/response protocol. NMSs can send multiple requests without receiving a response.

- **Get --** Allows the NMS to retrieve an object instance from the agent.
- **Set --** Allows the NMS to set values for object instances within an agent.
- **Trap --** Used by the agent to asynchronously inform the NMS of some event. The SNMPv2 trap message is designed to replace the SNMPv1 trap message.

SNMP Community

An SNMP community is the group that devices and management stations running SNMP belong to. It helps define where information is sent. The community name is used to identify the group. An SNMP device or agent may belong to more than one SNMP community. It will not respond to requests from management stations that do not belong to one of its communities.

SNMP default communities are:

- **Write** = private
- **Read** = public

4.2.7.2 SNMP System Information

Configure SNMP setting on this page. The SNMP System global setting screens in [Figure 4-2-21](#) & [Figure 4-2-22](#) appear.

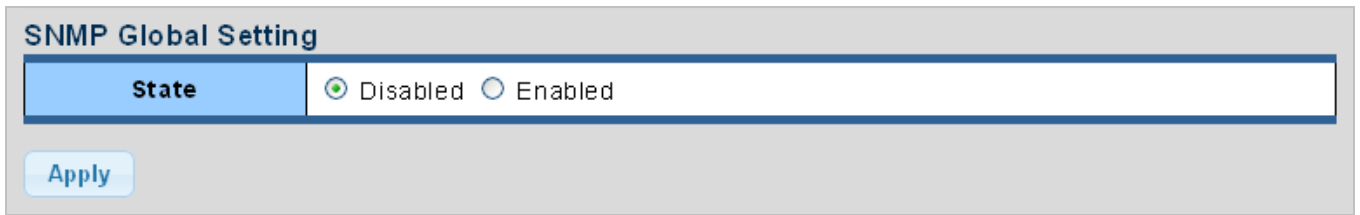

Figure 4-2-21 SNMP Global Setting Page Screenshot

The page includes the following fields:

| Object | Description |
|---|--|
| <ul style="list-style-type: none"> • Status | Indicates the SNMP mode operation. Possible modes are: Enabled: Enable SNMP mode operation. Disabled: Disable SNMP mode operation. |

Buttons



: Click to apply changes.

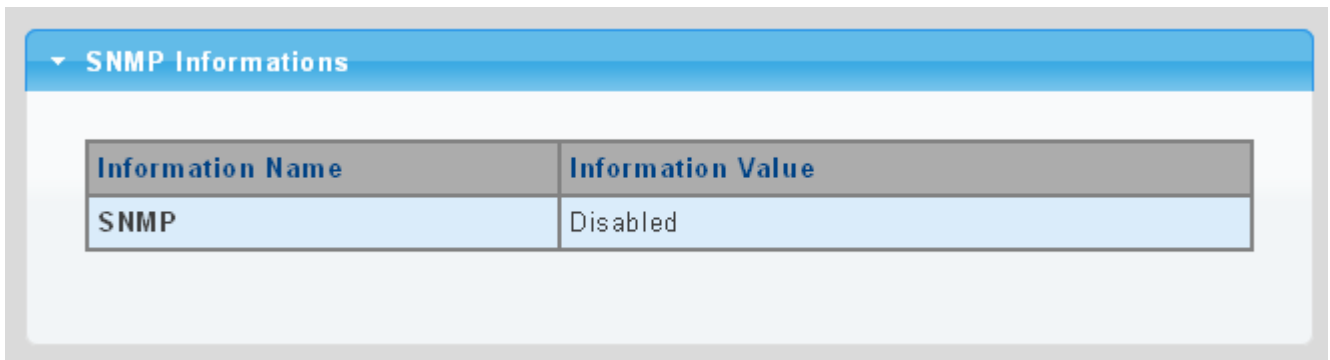

Figure 4-2-22 SNMP Information Page Screenshot

The page includes the following fields:

| Object | Description |
|---|---------------------------------|
| <ul style="list-style-type: none"> • SNMP | Display the current SNMP status |

4.2.7.3 SNMP View

Configure SNMPv3 view table on this page. The entry index keys are **View Name** and **OID Subtree**. The SNMPv3 View Table Setting screens in [Figure 4-2-23](#) and [Figure 4-2-24](#) appear.

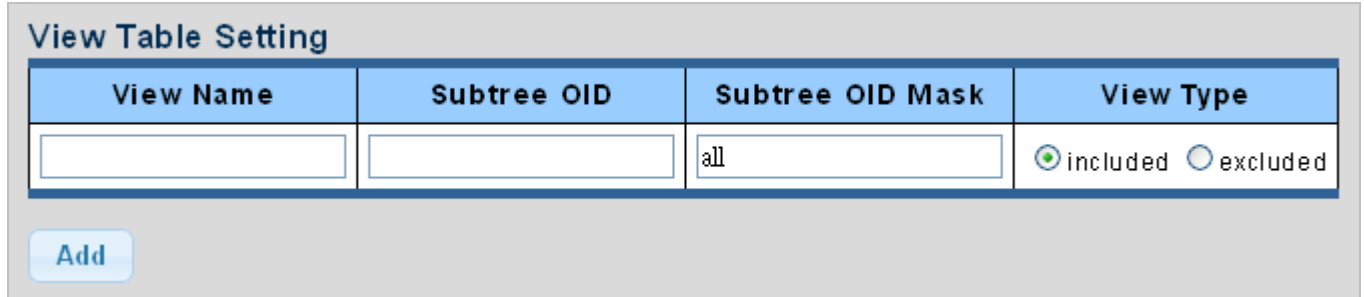

| View Name | Subtree OID | Subtree OID Mask | View Type |
|----------------------|----------------------|------------------|--|
| <input type="text"/> | <input type="text"/> | all | <input checked="" type="radio"/> included <input type="radio"/> excluded |

Figure 4-2-23 SNMPv3 View Table Setting Page Screenshot

The page includes the following fields:

| Object | Description |
|---|--|
| <ul style="list-style-type: none"> • View Name | <p>A string identifying the view name that this entry should belong to.</p> <p>The allowed string length is 1 to 16.</p> |
| <ul style="list-style-type: none"> • Subtree OID | <p>The OID defining the root of the subtree to add to the named view.</p> <p>The allowed string content is digital number or asterisk(*).</p> |
| <ul style="list-style-type: none"> • Subtree OID Mask | <p>The bitmask identifies which positions in the specified object identifier are to be regarded as "wildcards" for the purpose of pattern-matching.</p> |
| <ul style="list-style-type: none"> • View Type | <p>Indicates the view type that this entry should belong to. Possible view type are:</p> <p>included: An optional flag to indicate that this view subtree should be included.</p> <p>excluded: An optional flag to indicate that this view subtree should be excluded.</p> <p>General, if a view entry's view type is 'excluded', it should exist another view entry in which view type is 'included' and its OID subtree oversteps the 'excluded' view entry.</p> |

Buttons

: Click to add a new view entry.

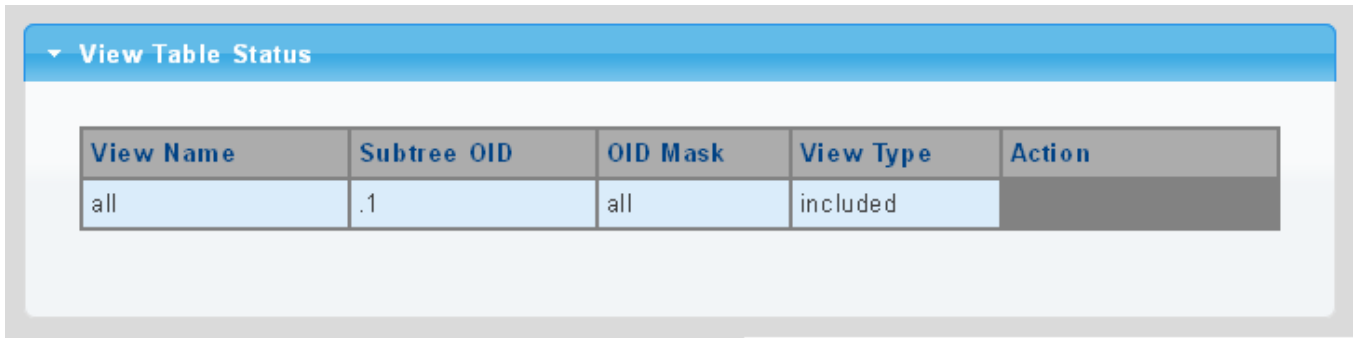

Figure 4-2-24 SNMP View Table Status Page Screenshot

The page includes the following fields:

| Object | Description |
|----------------------|---|
| • View Name | Display the current SNMP view name |
| • Subtree OID | Display the current SNMP subtree OID |
| • OID Mask | Display the current SNMP OID mask |
| • View Type | Display the current SNMP view type |
| • Action | Delete : Delete the view table entry. |

4.2.7.4 SNMP Access Group

Configure SNMPv3 access group on this page. The entry index keys are **Group Name**, **Security Model** and **Security Level**. The SNMPv3 Access Group Setting screens in [Figure 4-2-25](#) & [Figure 4-2-26](#) appear.

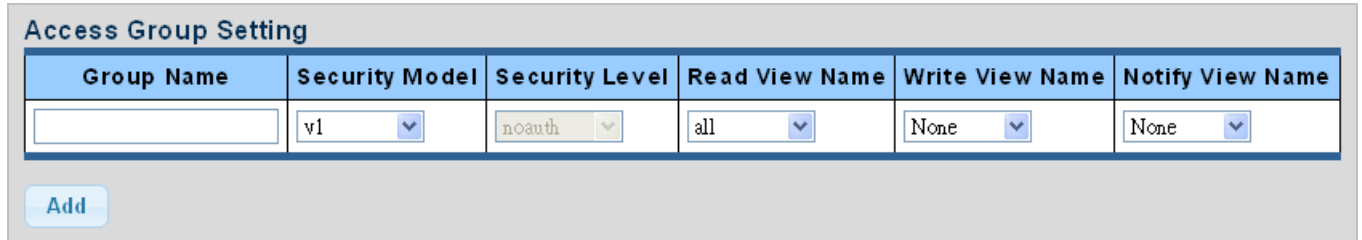

| Group Name | Security Model | Security Level | Read View Name | Write View Name | Notify View Name |
|----------------------|----------------|----------------|----------------|-----------------|------------------|
| <input type="text"/> | v1 | noauth | all | None | None |

Add

Figure 4-2-25 SNMPv3 Access Group Setting Page Screenshot

The page includes the following fields:

| Object | Description |
|---|--|
| <ul style="list-style-type: none"> • Group Name | <p>A string identifying the group name that this entry should belong to.</p> <p>The allowed string length is 1 to 16.</p> |
| <ul style="list-style-type: none"> • Security Model | <p>Indicates the security model that this entry should belong to.</p> <p>Possible security models are:</p> <ul style="list-style-type: none"> ■ v1: Reserved for SNMPv1. ■ v2c: Reserved for SNMPv2c. ■ V3: Reserved for SNMPv3 or User-based Security Model (USM) |
| <ul style="list-style-type: none"> • Security Level | <p>Indicates the security model that this entry should belong to.</p> <p>Possible security models are:</p> <ul style="list-style-type: none"> ■ Noauth: None authentication and none privacy security levels are assigned to the group. ■ auth: Authentication and none privacy. ■ priv: Authentication and privacy. <p>Note: The Security Level applies to SNNPv3 only.</p> |
| <ul style="list-style-type: none"> • Read View Name | <p>Read view name is the name of the view in which you can only view the contents of the agent.</p> <p>The allowed string length is 1 to 16.</p> |
| <ul style="list-style-type: none"> • Write View Name | <p>Write view name is the name of the view in which you enter data and configure the contents of the agent.</p> <p>The allowed string length is 1 to 16.</p> |
| <ul style="list-style-type: none"> • Notify View Name | <p>Notify view name is the name of the view in which you specify a notify, inform, or trap.</p> |

Buttons

Add: Click to add a new access entry.

Delete: Check to delete the entry.

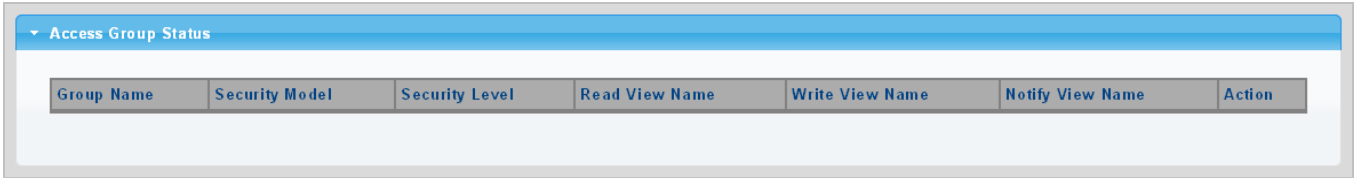

Figure 4-2-26 SNMP View Table Status Page Screenshot

The page includes the following fields:

| Object | Description |
|---------------------------|--|
| • Group Name | Display the current SNMP access group name |
| • Security Model | Display the current security model |
| • Security Level | Display the current security level |
| • Read View Name | Display the current read view name |
| • Write View Name | Display the current write view name |
| • Notify View Name | Display the current notify view name |
| • Action | Delete : Delete the access group entry. |

4.2.7.5 SNMP Community

Configure SNMP Community on this page. The SNMP Community screens in [Figure 4-2-27](#) & [Figure 4-2-28](#) appear.

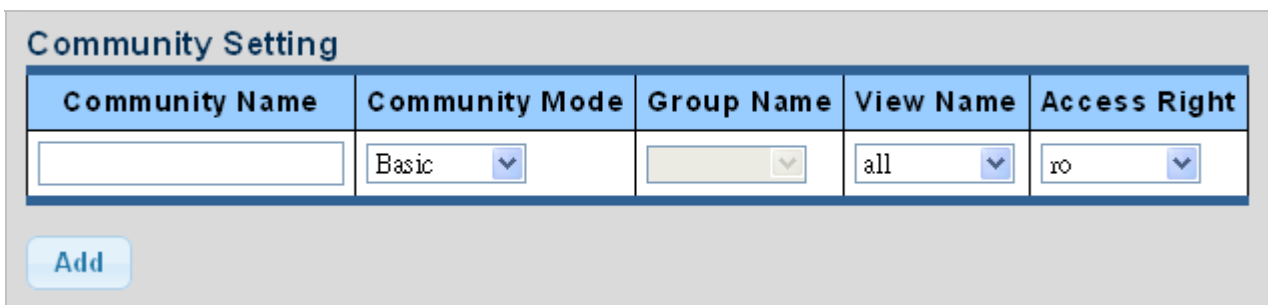

Figure 4-2-27 Community Setting Page Screenshot

The page includes the following fields:

| Object | Description |
|-------------------------|--|
| • Community Name | Indicates the community read/write access string to permit access to SNMP agent. The allowed string length is 0 to 16. |
| • Community Mode | Indicates the SNMP community supported mode. Possible versions are: <ul style="list-style-type: none"> ■ Basic: Set SNMP community mode supported version 1 and 2c. ■ Advanced: Set SNMP community mode supported version 3. |
| • Group Name | A string identifying the group name that this entry should belong to. The allowed string length is 1 to 16. |
| • View Name | A string identifying the view name that this entry should belong to. The allowed string length is 1 to 16. |
| • Access Right | Indicates the SNMP community type operation. Possible types are: <ul style="list-style-type: none"> RO=Read-Only: Set access string type in read-only mode. RW=Read-Write: Set access string type in read-write mode. |

Buttons

 : Click to apply changes.

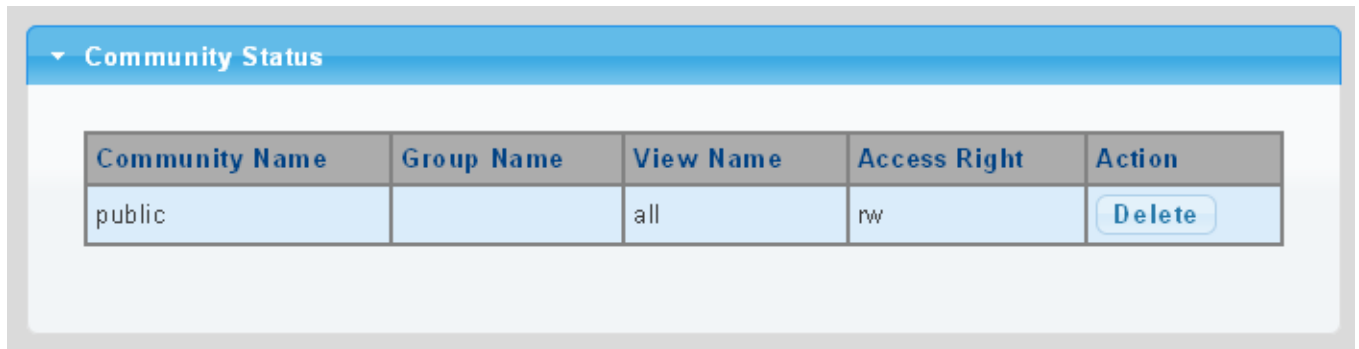



Figure 4-2-28 Community Status Page Screenshot

The page includes the following fields:

| Object | Description |
|-------------------------|--|
| • Community Name | Display the current community type |
| • Group Name | Display the current SNMP access group's name |
| • View Name | Display the current view name |
| • Access Right | Display the current access type |
| • Delete |  : Delete the community entry |

4.2.7.6 SNMP User

Configure SNMPv3 users table on this page. Each SNMPv3 user is defined by a unique name. Users must be configured with a specific security level and assigned to a group. The SNMPv3 group restricts users to a specific read, write, and notify view. The entry index key is **User Name**. The SNMPv3 User Setting screens in [Figure 4-2-29](#) & [Figure 4-2-30](#) appear.

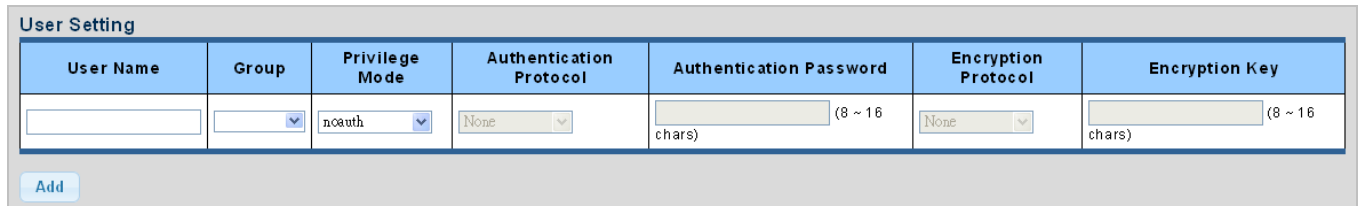

| User Name | Group | Privilege Mode | Authentication Protocol | Authentication Password | Encryption Protocol | Encryption Key |
|----------------------|-------------------------------|-------------------------------------|-----------------------------------|--|-----------------------------------|--|
| <input type="text"/> | <input type="text" value=""/> | <input type="text" value="noauth"/> | <input type="text" value="None"/> | <input type="text" value=""/> (8 ~ 16 chars) | <input type="text" value="None"/> | <input type="text" value=""/> (8 ~ 16 chars) |

Figure 4-2-29 SNMPv3 Users Configuration Page Screenshot

The page includes the following fields:

| Object | Description |
|--|--|
| <ul style="list-style-type: none"> User Name | <p>A string identifying the user name that this entry should belong to.</p> <p>The allowed string length is 1 to 16.</p> |
| <ul style="list-style-type: none"> Group | <p>The SNMP Access Group. A string identifying the group name that this entry should belong to.</p> |
| <ul style="list-style-type: none"> Privilege Mode | <p>Indicates the security model that this entry should belong to. Possible security models are:</p> <ul style="list-style-type: none"> ■ NoAuth: None authentication and none privacy. ■ Auth: Authentication and none privacy. ■ Priv: Authentication and privacy. <p>The value of security level cannot be modified if entry already exists. That means you must first ensure that the value is set correctly.</p> |
| <ul style="list-style-type: none"> Authentication Protocol | <p>Indicates the authentication protocol that this entry should belong to. Possible authentication protocols are:</p> <ul style="list-style-type: none"> ■ None: None authentication protocol. ■ MD5: An optional flag to indicate that this user using MD5 authentication protocol. ■ SHA: An optional flag to indicate that this user using SHA authentication protocol. <p>The value of security level cannot be modified if entry already exist. That means you must first ensure that the value is set correctly.</p> |
| <ul style="list-style-type: none"> Authentication Password | <p>A string identifying the authentication pass phrase. For both MD5 and SHA authentication protocol, the allowed string length is 8 to 16.</p> |
| <ul style="list-style-type: none"> Encryption Protocol | <p>Indicates the privacy protocol that this entry should belong to. Possible privacy</p> |

| | |
|---|--|
| | <p>protocol are:</p> <ul style="list-style-type: none"> ■ None: None privacy protocol. ■ DES: An optional flag to indicate that this user using DES authentication protocol. |
| <ul style="list-style-type: none"> • Encryption Key | <p>A string identifying the privacy pass phrase. The allowed string length is 8 to 16.</p> |

Buttons



: Click to add a new user entry.

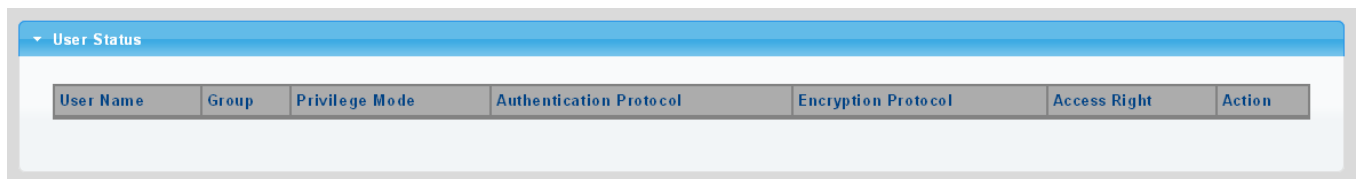



Figure 4-2-30 SNMPv3 Users Status Page Screenshot

The page includes the following fields:

| Object | Description |
|----------------------------------|---|
| • User Name | Display the current user name |
| • Group | Display the current group |
| • Privilege Mode | Display the current privilege mode |
| • Authentication Protocol | Display the current authentication protocol |
| • Encryption Protocol | Display the current encryption protocol |
| • Access Right | Display the current access right |
| • Action |  : Delete the user entry |

4.2.7.7 SNMPv1, 2 Notification Recipients

Configure SNMPv1 and 2 notification recipients on this page. The SNMPv1, 2 Notification Recipients screens in [Figure 4-2-31](#) & [Figure 4-2-32](#) appear.



Figure 4-2-31 SNMPv1, 2 Notification Recipients Page Screenshot

The page includes the following fields:

| Object | Description |
|-------------------------|--|
| • Server Address | Indicates the SNMP trap destination address. It allow a valid IP address in dotted decimal notation ('x.y.z.w'). It can also represent a legally valid IPv4 address. For example, '192.1.2.34'. |
| • SNMP Version | Indicates the SNMP trap supported version. Possible versions are: <ul style="list-style-type: none"> ■ SNMP v1: Set SNMP trap supported version 1. ■ SNMP v2c: Set SNMP trap supported version 2c. |
| • Notify Type | Set the notify type in traps or informs. |
| • Community Name | Indicates the community access string when send SNMP trap packet. |
| • UDP Port | Indicates the SNMP trap destination port. SNMP Agent will send SNMP message via this port, the port range is 1~65535. |
| • Time Out | Indicates the SNMP trap inform timeout. The allowed range is 1 to 300 . |
| • Retries | Indicates the SNMP trap inform retry times. The allowed range is 1 to 255 . |

Buttons

Add : Click to add a new SNMPv1, 2 host entry.

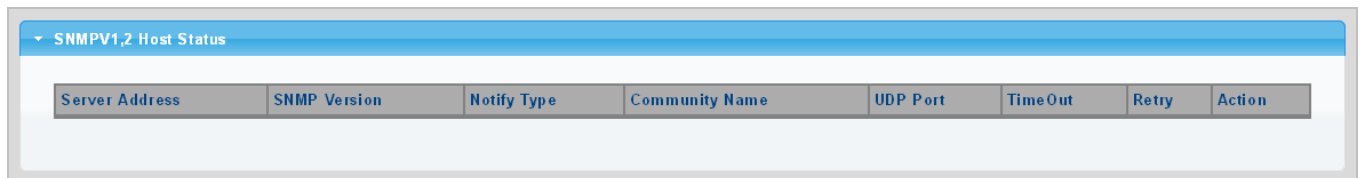

Figure 4-2-32 SNMPv1, 2 Host Status Page Screenshot

The page includes the following fields:

| Object | Description |
|-------------------------|--|
| • Server Address | Display the current server address |
| • SNMP Version | Display the current SNMP version |
| • Notify Type | Display the current notify type |
| • Community Name | Display the current community name |
| • UDP Port | Display the current UDP port |
| • Time Out | Display the current time out |
| • Retries | Display the current retry times |
| • Action | Delete : Delete the SNMPv1, 2 host entry. |

4.2.7.9 SNMPv3 Notification Recipients

Configure SNMPv3 notification recipients on this page. The SNMPv1, 2 Notification Recipients screens in [Figure 4-2-33](#) & [Figure 4-2-34](#) appear.

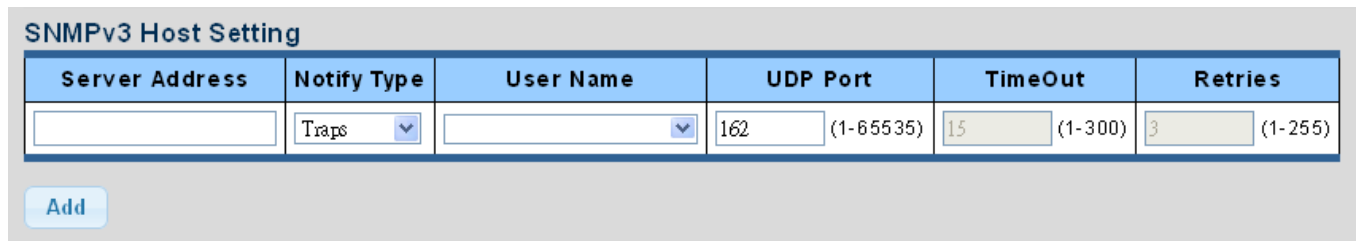

The screenshot shows a form titled "SNMPv3 Host Setting" with the following fields:

| Server Address | Notify Type | User Name | UDP Port | TimeOut | Retries |
|----------------------|--|----------------------|---------------|------------|-----------|
| <input type="text"/> | Traps <input type="button" value="v"/> | <input type="text"/> | 162 (1-65535) | 15 (1-300) | 3 (1-255) |

Below the table is an "Add" button.

Figure 4-2-33 SNMPv3 Notification Recipients Page Screenshot

The page includes the following fields:

| Object | Description |
|-------------------------|--|
| • Server Address | Indicates the SNMP trap destination address. It allows a valid IP address in dotted decimal notation ('x.y.z.w'). It can also represent a legally valid IPv4 address. For example, '::192.1.2.34'. |
| • Notify Type | Set the notify type in traps or informs. |
| • User Name | Indicates the user string when send SNMP trap packet. |
| • UDP Port | Indicates the SNMP trap destination port. SNMP Agent will send SNMP message via this port, the port range is 1~65535. |
| • Time Out | Indicates the SNMP trap inform timeout. The allowed range is 1 to 300 . |
| • Retries | Indicates the SNMP trap inform retry times. The allowed range is 1 to 255 . |

Buttons



: Click to add a new SNMPv3 host entry.

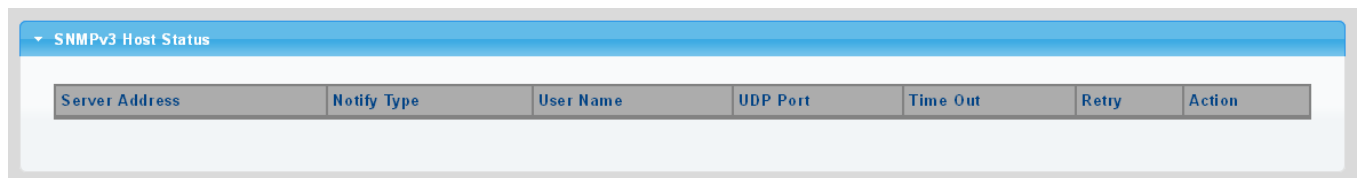

The screenshot shows a table titled "SNMPv3 Host Status" with the following columns:

| Server Address | Notify Type | User Name | UDP Port | Time Out | Retry | Action |
|----------------|-------------|-----------|----------|----------|-------|--------|
|----------------|-------------|-----------|----------|----------|-------|--------|

Figure 4-2-34 SNMPv3 Host Status Page Screenshot

The page includes the following fields:

| Object | Description |
|-------------------------|------------------------------------|
| • Server Address | Display the current server address |
| • Notify Type | Display the current notify type |

| | |
|--------------------|--|
| • User Name | Display the current user name |
| • UDP Port | Display the current UDP port |
| • Time Out | Display the current time out |
| • Retries | Display the current retry times |
| • Action |  : Delete the SNMPv3 host entry |

4.2.7.10 SNMP Engine ID

Configure SNMPv3 Engine ID on this page. The entry index key is Engine ID. The remote engine ID is used to compute the security digest for authenticating and encrypting packets sent to a user on the remote host. The SNMPv3 Engine ID Setting screens in [Figure 4-2-35](#) & [Figure 4-2-36](#) appear.

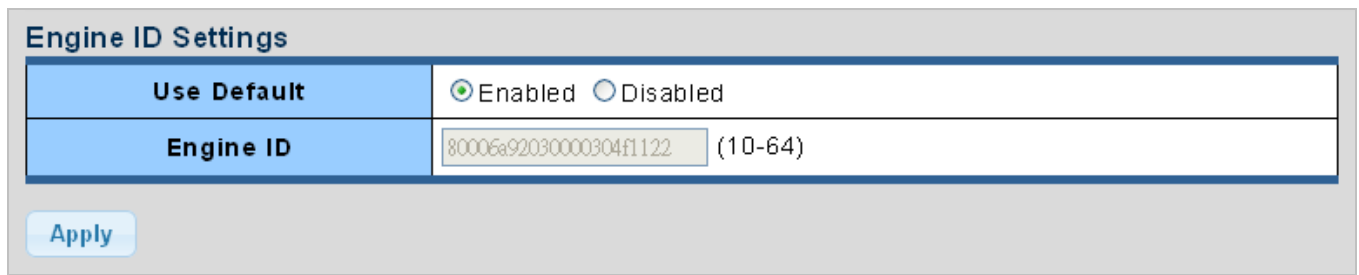

Figure 4-2-35 SNMPv3 Engine ID Setting Page Screenshot

The page includes the following fields:

| Object | Description |
|--------------------|--|
| • Engine ID | An octet string identifying the engine ID that this entry should belong to. The string must contain an even number between 10 and 64 hexadecimal digits, but all-zeros and all-'F's are not allowed. |

Buttons

: Click to apply changes.

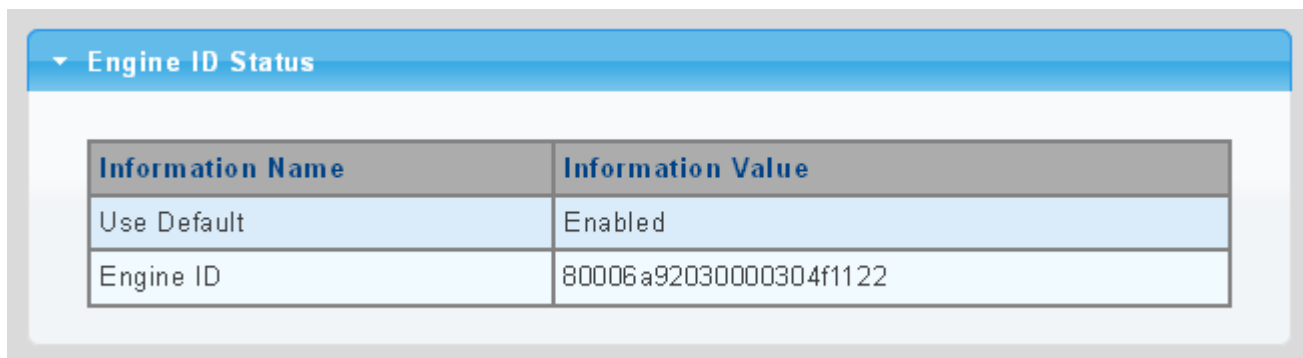

| Information Name | Information Value |
|------------------|------------------------|
| Use Default | Enabled |
| Engine ID | 80006a92030000304f1122 |

Figure 4-2-36 SNMPv3 Engine ID Status Page Screenshot

The page includes the following fields:

| Object | Description |
|----------------|-------------------------------|
| • User Default | Display the current status |
| • Engine ID | Display the current engine ID |

4.2.7.11 SNMP Remote Engine ID

Configure SNMPv3 remote Engine ID on this page. The SNMPv3 Remote Engine ID Setting screens in [Figure 4-2-37](#) & [Figure 4-2-38](#) appear.

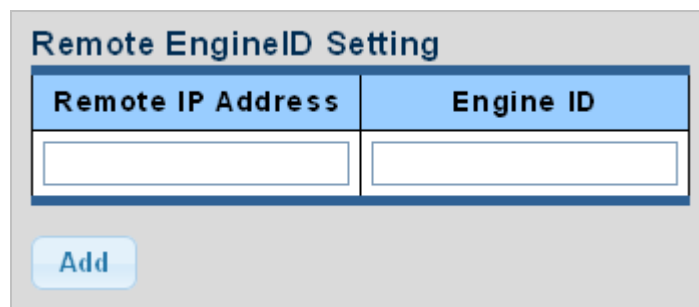

| Remote IP Address | Engine ID |
|----------------------|----------------------|
| <input type="text"/> | <input type="text"/> |

Figure 4-2-37 SNMPv3 Remote Engine ID Setting Page Screenshot

The page includes the following fields:

| Object | Description |
|---------------------|---|
| • Remote IP Address | Indicates the SNMP remote engine ID address. It allows a valid IP address in dotted decimal notation ('x.y.z.w'). |
| • Engine ID | An octet string identifying the engine ID that this entry should belong to. |

Buttons

: Click to apply changes.

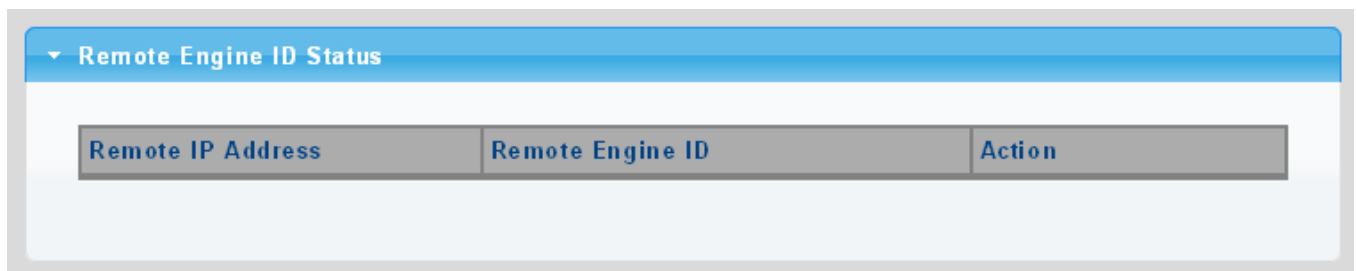

| Remote Engine ID Status | | |
|-------------------------|------------------|--------|
| Remote IP Address | Remote Engine ID | Action |
| | | |

Figure 4-2-38 SNMPv3 Remote Engine ID Status Page Screenshot

The page includes the following fields:

| Object | Description |
|---------------------|--|
| • Remote IP Address | Display the current remote IP address |
| • Engine ID | Display the current engine ID |
| • Action | Delete : Delete the remote IP address entry |

4.3 Port Management

Use the Port Menu to display or configure the LRP Managed Switch's ports. This section has the following items:

- **Port Configuration** Configures port configuration settings
- **LRP Port Configuration** Configures LRP port configuration settings
- **Port Counters** Lists Ethernet and RMON port statistics
- **Bandwidth Utilization** Displays current bandwidth utilization
- **Port Mirroring** Sets the source and target ports for mirroring
- **Jumbo Frame** Sets the jumbo frame on the switch
- **Port Error Disable Configuration** Configures port error disable settings
- **Port Error Disabled Status** Disables port error status
- **Protected Ports** Configures protected ports settings
- **EEE** Configures EEE settings
- **SFP Module Information** Displays SFP module information.

4.3.1 Port Configuration

This page displays current port configurations and status. Ports can also be configured here. The table has one row for each port on the selected switch in a number of columns, which are:

The Port Configuration screens in [Figure 4-3-1A](#) & [Figure 4-3-2A](#) appear.

Port settings

| Port Select | Enabled | Speed | Duplex | Flow Control |
|----------------|---|--------------|--------|---|
| Select Ports ▾ | <input checked="" type="radio"/> Enabled <input type="radio"/> Disabled | Auto ▾ | Auto ▾ | <input type="radio"/> Enabled <input checked="" type="radio"/> Disabled |
| Fiber Ports ▾ | <input checked="" type="radio"/> Enabled <input type="radio"/> Disabled | Auto-1000M ▾ | Full ▾ | <input type="radio"/> Enabled <input checked="" type="radio"/> Disabled |

Apply

Figure 4-3-1A Port Settings Page Screenshot

The page includes the following fields:

| Object | Description |
|---|--|
| <ul style="list-style-type: none"> • Port Select | Select port number from this drop-down list. |
| <ul style="list-style-type: none"> • Enabled | Indicates the port state operation. Possible states are: Enabled - Start up the port manually. Disabled – Shut down the port manually. |
| <ul style="list-style-type: none"> • Speed | Select any available link speed for the given switch port. Draw the menu bar to select the mode. <ul style="list-style-type: none"> ■ Auto - Setup Auto negotiation. ■ Auto-10M - Setup 10M Auto negotiation. ■ Auto-100M - Setup 100M Auto negotiation. ■ Auto-1000M - Setup 1000M Auto negotiation. ■ Auto-10/100M - Setup 10/100M Auto negotiation. ■ 10M - Setup 10M Force mode. ■ 100M - Setup 100M Force mode. ■ 1000M - Setup 1000M Force mode. |
| <ul style="list-style-type: none"> • Duplex | Select any available link duplex for the given switch port. Draw the menu bar to select the mode. <ul style="list-style-type: none"> ■ Auto - Setup Auto negotiation. ■ Full - Force sets Full-Duplex mode. ■ Half - Force sets Half-Duplex mode. |
| <ul style="list-style-type: none"> • Flow Control | When Auto Speed is selected for a port, this section indicates the flow control capability that is advertised to the link partner. When a fixed-speed setting is selected, that is what is used. Current Rx column indicates whether pause frames on the port are obeyed. Current Tx column indicates whether pause frames on the port are transmitted. The Rx and Tx settings are determined by the result of the last Auto-Negotiation. Check the configured column to use flow control. This setting is related to the setting for Configured Link Speed. |

Buttons



: Click to apply changes.

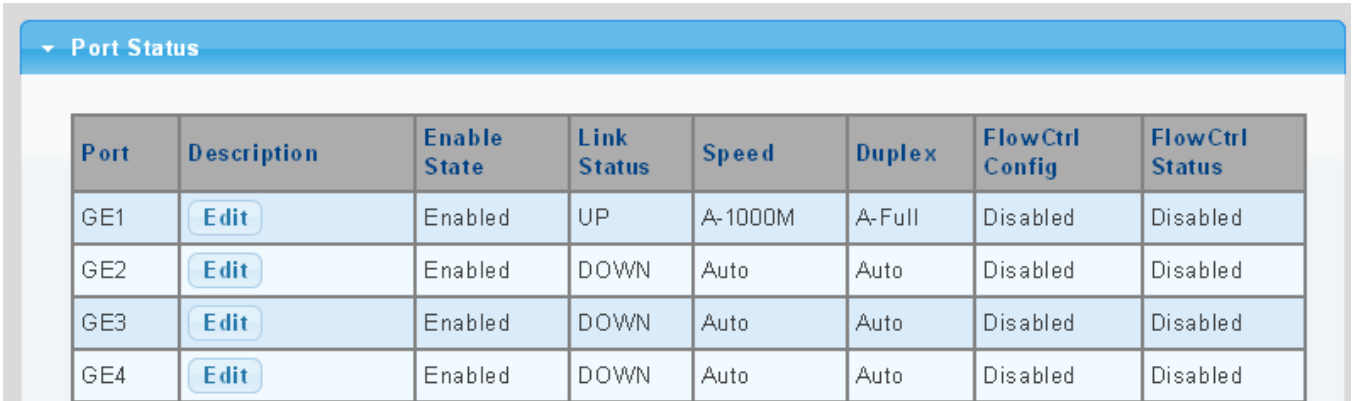

| Port | Description | Enable State | Link Status | Speed | Duplex | FlowCtrl Config | FlowCtrl Status |
|------|----------------------|--------------|-------------|---------|--------|-----------------|-----------------|
| GE1 | Edit | Enabled | UP | A-1000M | A-Full | Disabled | Disabled |
| GE2 | Edit | Enabled | DOWN | Auto | Auto | Disabled | Disabled |
| GE3 | Edit | Enabled | DOWN | Auto | Auto | Disabled | Disabled |
| GE4 | Edit | Enabled | DOWN | Auto | Auto | Disabled | Disabled |

Figure 4-3-2A Port Status Page Screenshot

The page includes the following fields:

| Object | Description |
|------------------------------|--|
| • Port | This is the logical port number for this row |
| • Description | Click Edit to indicate the port name |
| • Enable State | Display the current port state |
| • Link Status | Display the current link status |
| • Speed | Display the current speed status of the port |
| • Duplex | Display the current duplex status of the port |
| • Flow Control Configuration | Display the current flow control configuration of the port |
| • Flow Control Status | Display the current flow control status of the port |

4.3.2 LRP Port Configuration

This page displays current LRP port configurations and status. Ports can also be configured here. The table has one row for each port on the selected switch in a number of columns, which are:

The Port Configuration screens in [Figure 4-3-1B](#) & [Figure 4-3-2B](#) appear.

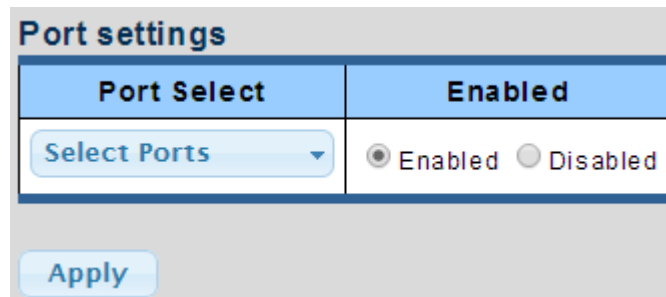



Figure 4-3-1B LRP Port Settings Page Screenshot

The page includes the following fields:

| Object | Description |
|--|---|
| <ul style="list-style-type: none"> • Port Select | Select port number from this drop-down list. |
| <ul style="list-style-type: none"> • Enabled | Indicates the port state operation. Possible state are: Enabled - Start up the port manually. Disabled – Shut down the port manually. |

Buttons

 : Click to apply changes.

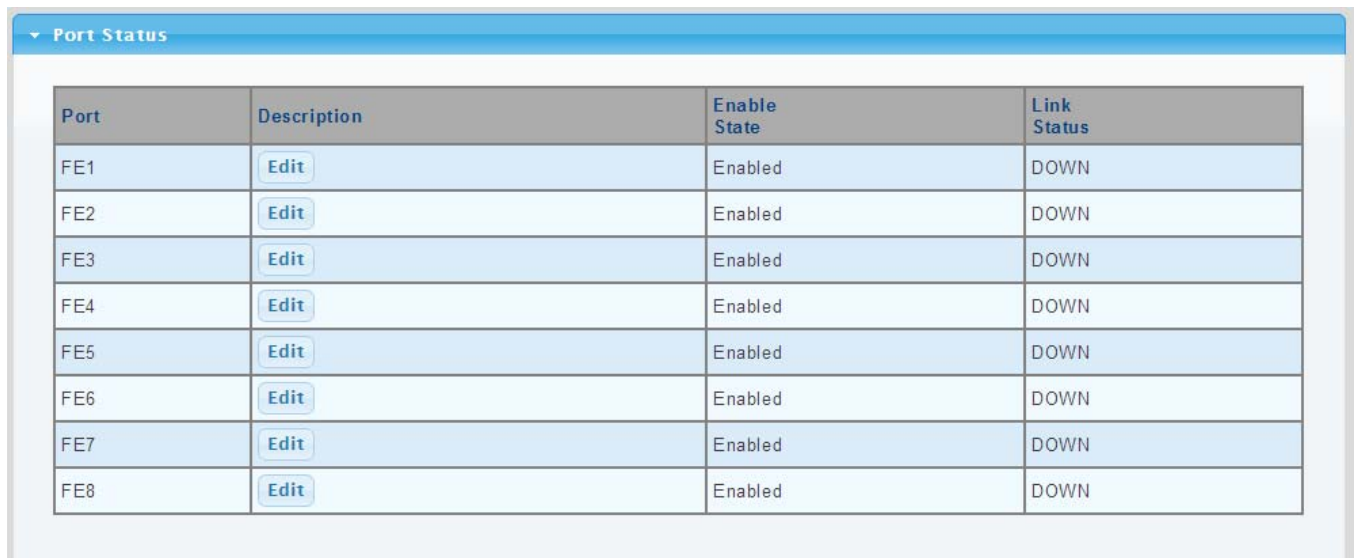



Figure 4-3-2B Port Status Page Screenshot

The page includes the following fields:

| Object | Description |
|---|---|
| <ul style="list-style-type: none"> • Port | This is the logical port number for this row |
| <ul style="list-style-type: none"> • Description | Click  to indicate the port name |
| <ul style="list-style-type: none"> • Enable State | Display the current port state |
| <ul style="list-style-type: none"> • Link Status | Display the current link status |

4.3.3 Port Counters

This page provides an overview of traffic and trunk statistics for all switch ports. The Port Statistics screens in [Figure 4-3-3](#), [Figure 4-3-4](#), [Figure 4-3-5](#) & [Figure 4-3-6](#) appear.

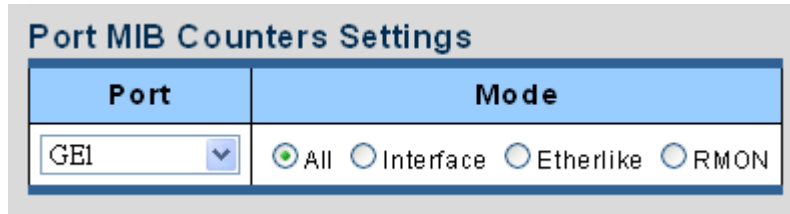

Figure 4-3-3 Port MIB Counters Page Screenshot

The page includes the following fields:

| Object | Description |
|--|--|
| <ul style="list-style-type: none"> • Port | Select port number from this drop-down list. |
| <ul style="list-style-type: none"> • Mode | Select port counters mode. Option: <ul style="list-style-type: none"> • All • Interface • Ether-link • RMON |

| Interface Counters | Counters Value |
|----------------------------------|----------------|
| Received Octets | 0 |
| Received Unicast Packets | 0 |
| Received Unknown Unicast Packets | 0 |
| Received Discards Packets | 0 |
| Transmit Octets | 0 |
| Transmit Unicast Packets | 0 |
| Transmit Unknown Unicast Packets | 0 |
| Transmit Discards Packets | 0 |
| Received Multicast Packets | 0 |
| Received Broadcast Packets | 0 |
| Transmit Multicast Packets | 0 |
| Transmit Broadcast Packets | 0 |

Figure 4-3-4 Interface Counters Page Screenshot

| Object | Description |
|---|--|
| <ul style="list-style-type: none"> • Received Octets | <p>The total number of octets received on the interface, including framing characters.</p> |
| <ul style="list-style-type: none"> • Received Unicast Packets | <p>The number of subnetwork-unicast packets delivered to a higher-layer protocol.</p> |
| <ul style="list-style-type: none"> • Received Unknown Unicast Packets | <p>The number of packets received via the interface which is discarded because of an unknown or unsupported protocol.</p> |
| <ul style="list-style-type: none"> • Received Discarded Packets | <p>The number of inbound packets which were chosen to be discarded even though no errors had been detected to prevent their being deliverable to a higher-layer protocol. One possible reason for discarding such a packet could be to free up buffer space.</p> |
| <ul style="list-style-type: none"> • Transmit Octets | <p>The total number of octets transmitted out of the interface, including framing characters.</p> |
| <ul style="list-style-type: none"> • Transmit Unicast Packets | <p>The total number of packets that higher-level protocols requested is transmitted to a subnetwork-unicast address, including those that were discarded or not sent.</p> |
| <ul style="list-style-type: none"> • Transmit Unknown Unicast Packets | <p>The total number of packets that higher-level protocols requested is transmitted to a subnetwork-unicast address, including those that were discarded or not sent.</p> |
| <ul style="list-style-type: none"> • Transmit Discarded Packets | <p>The number of inbound packets which is chosen to be discarded even though no errors have been detected to prevent from being delivered to a higher-layer protocol. One possible reason for discarding such a packet could be to free up buffer space.</p> |
| <ul style="list-style-type: none"> • Received Multicast Packets | <p>The number of packets, delivered by this sub-layer to a higher (sub-) layer, is addressed to a multicast address at this sub-layer.</p> |
| <ul style="list-style-type: none"> • Received Broadcast Packets | <p>The number of packets, delivered by this sub-layer to a higher (sub-) layer, addressed to a broadcast address at this sub-layer.</p> |
| <ul style="list-style-type: none"> • Transmit Multicast Packets | <p>The total number of packets that higher-level protocols requested is transmitted and is addressed to a multicast address at this sub-layer, including those that were discarded or not sent.</p> |
| <ul style="list-style-type: none"> • Transmit Broadcast Packets | <p>The total number of packets that higher-level protocols requested is transmitted, and addressed to a broadcast address at this sub-layer, including those that were discarded or not sent.</p> |

| Ethernet-link Counters | Counters Value |
|----------------------------|----------------|
| Alignment Errors | 0 |
| FCS Errors | 0 |
| Single Collision Frames | 0 |
| Multiple Collision Frames | 0 |
| Deferred Transmissions | 0 |
| Late Collision | 0 |
| Excessive Collision | 0 |
| Frame Too Longs | 0 |
| Symbol Errors | 0 |
| Control In Unknown Opcodes | 0 |
| In Pause Frames | 0 |
| Out Pause Frames | 0 |

Figure 4-3-5 Ethernet link Counters Page Screenshot

| Object | Description |
|---|---|
| <ul style="list-style-type: none"> • Alignment Errors | The number of alignment errors (missynchronized data packets). |
| <ul style="list-style-type: none"> • FCS Errors | A count of frames received on a particular interface that are an integral number of octets in length but do not pass the FCS check. This count does not include frames received with frame-too-long or frame-too-short error. |
| <ul style="list-style-type: none"> • Single Collision Frames | The number of successfully transmitted frames for which transmission is inhibited by exactly one collision. |
| <ul style="list-style-type: none"> • Multiple Collision Frames | A count of successfully transmitted frames for which transmission is inhibited by more than one collision. |
| <ul style="list-style-type: none"> • Deferred Transmissions | A count of frames for which the first transmission attempt on a particular interface is delayed because the medium was busy. |
| <ul style="list-style-type: none"> • Late Collision | The number of times that a collision is detected later than 512 bit-times into the transmission of a packet. |
| <ul style="list-style-type: none"> • Excessive Collision | A count of frames for which transmission on a particular interface fails due to excessive collisions. This counter does not increase when the interface is operating in full-duplex mode. |
| <ul style="list-style-type: none"> • Frame Too Long | A count of frames received on a particular interface that exceeds the maximum permitted frame size. |
| <ul style="list-style-type: none"> • Symbol Errors | The number of received and transmitted symbol errors |
| <ul style="list-style-type: none"> • Control In Unknown Opcodes | The number of received control unknown opcodes |
| <ul style="list-style-type: none"> • In Pause Frames | The number of received pause frames |
| <ul style="list-style-type: none"> • Out Pause Frames | The number of transmitted pause frames |

| RMON Counters | Counters Value |
|------------------------|----------------|
| Drop Events | 0 |
| Octets | 0 |
| Packets | 0 |
| Broadcast Packets | 0 |
| Multicast Packets | 0 |
| CRC / Alignment Errors | 0 |
| Undersize Packets | 0 |
| Oversize Packets | 0 |
| Fragments | 0 |
| Jabbers | 0 |
| Collisions | 0 |
| 64 Bytes Frame | 0 |
| 65-127 Byte Frames | 0 |
| 128-255 Byte Frames | 0 |
| 256-511 Byte Frames | 0 |
| 512-1023 Byte Frames | 0 |
| 1024-1518 Byte Frames | 0 |

Figure 4-3-6 RMON Counters Page Screenshot

| Object | Description |
|---|---|
| <ul style="list-style-type: none"> • Drop Events | The total number of events in which packets were dropped due to lack of resources. |
| <ul style="list-style-type: none"> • Octets | The total number of octets received and transmitted on the interface, including framing characters. |
| <ul style="list-style-type: none"> • Packets | The total number of packets received and transmitted on the interface. |
| <ul style="list-style-type: none"> • Broadcast Packets | The total number of good frames received that were directed to the broadcast address. Note that this does not include multicast packets. |
| <ul style="list-style-type: none"> • Multicast Packets | The total number of good frames received that were directed to this multicast address. |
| <ul style="list-style-type: none"> • CRC / Alignment Errors | The number of CRC/alignment errors (FCS or alignment errors). |
| <ul style="list-style-type: none"> • Undersize Packets | The total number of frames received that were less than 64 octets long (excluding framing bits, but including FCS octets) and were otherwise well formed. |
| <ul style="list-style-type: none"> • Oversize Packets | The total number of frames received that were longer than 1518 octets (excluding framing bits, but including FCS octets) and were otherwise well formed. |

| | |
|--|---|
| <ul style="list-style-type: none"> • Fragments | <p>The total number of frames received that were less than 64 octets in length (excluding framing bits, but including FCS octets) and had either an FCS or alignment error.</p> |
| <ul style="list-style-type: none"> • Jabbers | <p>The total number of frames received that were longer than 1518 octets (excluding framing bits, but including FCS octets), and had either an FCS or alignment error.</p> |
| <ul style="list-style-type: none"> • Collisions | <p>The best estimate of the total number of collisions on this Ethernet segment.</p> |
| <ul style="list-style-type: none"> • 64 Bytes Frames | <p>The total number of frames (including bad packets) received and transmitted that were 64 octets in length (excluding framing bits but including FCS octets).</p> |
| <ul style="list-style-type: none"> • 65-127 Byte Frames • 128-255 Byte Frames • 256-511 Byte Frames • 512-1023 Byte Frames • 1024-1518 Byte Frames | <p>The total number of frames (including bad packets) received and transmitted where the number of octets falls within the specified range (excluding framing bits but including FCS octets).</p> |

4.3.4 Bandwidth Utilization

The **Bandwidth Utilization** page displays the percentage of the total available bandwidth being used on the ports. Bandwidth utilization statistics can be viewed using a line graph. The Bandwidth Utilization screen in [Figure 4-3-7](#) appears.

To view the port utilization, click on the **Port Management** folder and then the **Bandwidth Utilization** link:

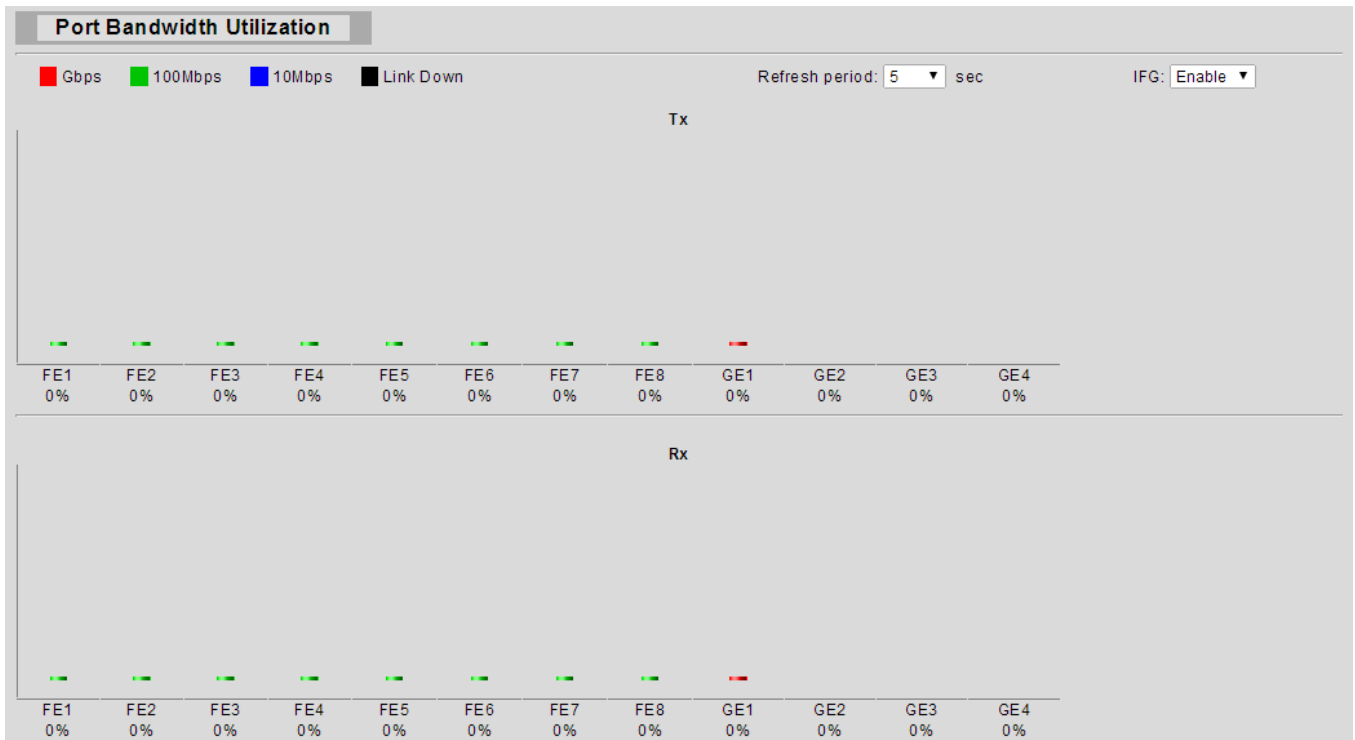

Figure 4-3-7 Port Bandwidth Utilization Page Screenshot

The page includes the following fields:

| Object | Description |
|---|--|
| <ul style="list-style-type: none"> • Refresh Period | This shows the period interval between last and next refresh. Options: <ul style="list-style-type: none"> ■ 2 sec ■ 5 sec ■ 10 sec |
| <ul style="list-style-type: none"> • IFG | Allow user to enable or disable this function |

4.3.5 Port Mirroring

Configure port Mirroring on this page. This function provides monitoring of network traffic that forwards a copy of each incoming or outgoing packet from one port of a network switch to another port where the packet can be studied. It enables the manager to keep close track of switch performance and alter it if necessary.

- To debug network problems, selected traffic can be copied, or mirrored, to a mirror port where a frame analyzer can be attached to analyze the frame flow.
- The LRP Managed Switch can unobtrusively mirror traffic from any port to a monitor port. You can then attach a protocol analyzer or RMON probe to this port to perform traffic analysis and verify connection integrity.

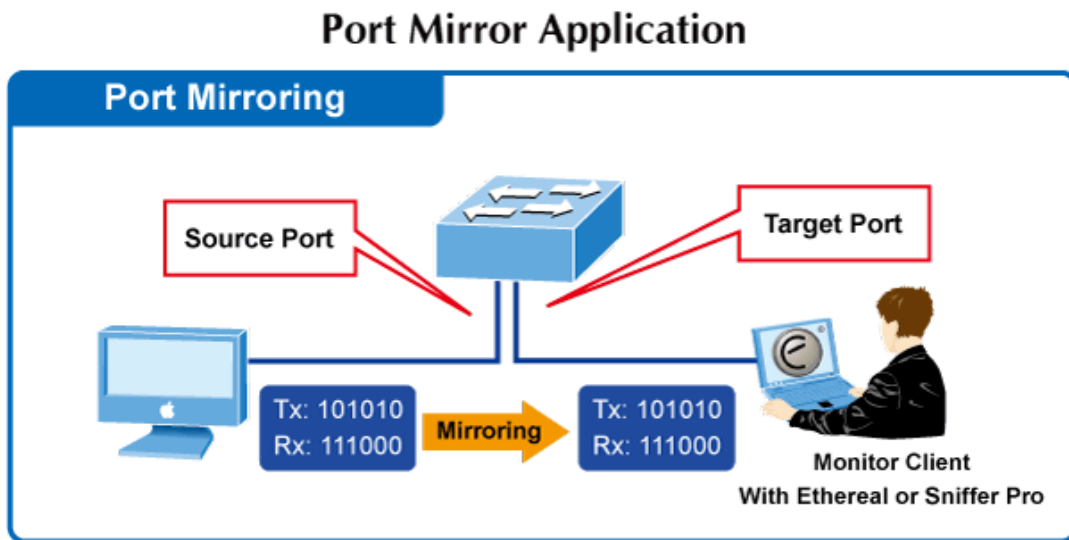

Figure 4-3-8 Port Mirror Application

The traffic to be copied to the mirror port is selected as follows:

- All frames received on a given port (also known as ingress or source mirroring).
- All frames transmitted on a given port (also known as egress or destination mirroring).

Mirror Port Configuration

The Port Mirror Configuration screens in [Figure 4-3-9](#) & [Figure 4-3-10](#) appear.

Mirror Setting

| | |
|------------------------------|-------------------|
| Session ID | Select Session ▾ |
| Monitor session state | Disable ▾ |
| Destination Port | GE1 ▾ |
| allow-ingress | Disable ▾ |
| Sniffer RX Ports | Select RX Ports ▾ |
| Sniffer TX Ports | Select TX Ports ▾ |

Apply

Figure 4-3-9 Port Mirroring Settings Page Screenshot

The page includes the following fields:

| Object | Description |
|--------------------------------|---|
| • Session ID | Set the port mirror session ID. Possible ID are: 1 to 4 . |
| • Monitor Session State | Enable or disable the port mirroring function. |
| • Destination Port | Select the port to mirror destination port. |
| • Allow-ingress | Frames from ports that have either source (RX) or destination (TX) mirroring enabled are mirrored to this port. |
| • Sniffer TX Ports | Frames transmitted from these ports are mirrored to the mirroring port. Frames received are not mirrored. |
| • Sniffer RX Ports | Frames received at these ports are mirrored to the mirroring port. Frames transmitted are not mirrored. |

Buttons

Apply: Click to apply changes.

▼ Mirror Status

| Session ID | Destination Port | Ingress State | Source TX Port | Source RX Port |
|------------|------------------|---------------|----------------|----------------|
| 1 | N/A | N/A | N/A | N/A |
| 2 | N/A | N/A | N/A | N/A |
| 3 | N/A | N/A | N/A | N/A |
| 4 | N/A | N/A | N/A | N/A |

Figure 4-3-10 Mirroring Status Page Screenshot

The page includes the following fields:

| Object | Description |
|--------------------|----------------------------------|
| • Session ID | Display the session ID |
| • Destination Port | This is the mirroring port entry |
| • Ingress State | Display the ingress state |
| • Source TX Port | Display the current TX ports |
| • Source RX Port | Display the current RX ports |

4.3.6 Jumbo Frame

This page provides to select the maximum frame size allowed for the switch port. The Jumbo Frame screens in [Figure 4-3-11](#) & [Figure 4-3-12](#) appear.



Figure 4-3-11 Jumbo Frame Setting Page Screenshot

The page includes the following fields:

| Object | Description |
|-----------------------|--|
| • Jumbo Frame (Bytes) | Enter the maximum frame size allowed for the switch port, including FCS. The allowed range is 64 bytes to 9216 bytes. |

Buttons

Apply: Click to apply changes.

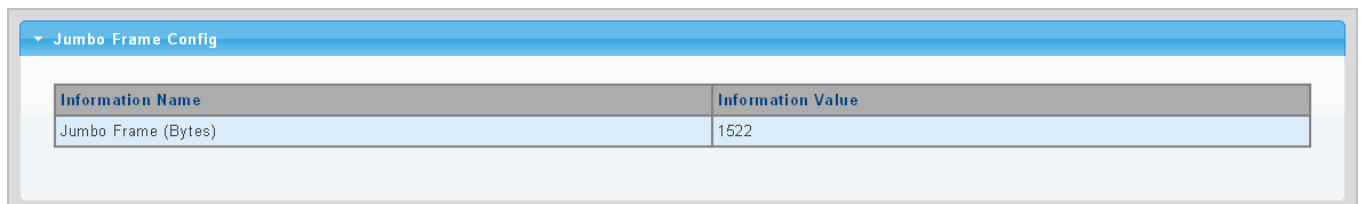

Figure 4-3-12 Jumbo Frame Information Page Screenshot

The page includes the following fields:

| Object | Description |
|---------|--|
| • Jumbo | Display the current maximum frame size |



Jumbo Frame is available for GE1~GE4 only.

4.3.7 Port Error Disabled Configuration

This page provides to set port error disable function. The Port Error Disable Configuration screens in [Figure 4-3-13](#) & [Figure 4-3-14](#) appear.

Error Disabled Recovery

| | |
|--------------------------------|---|
| Recovery Interval | <input type="text" value="300"/> (Seconds) |
| BPDU Guard | <input type="radio"/> Enabled <input checked="" type="radio"/> Disabled |
| Self Loop | <input type="radio"/> Enabled <input checked="" type="radio"/> Disabled |
| Broadcast Flood | <input type="radio"/> Enabled <input checked="" type="radio"/> Disabled |
| Unknown Multicast Flood | <input type="radio"/> Enabled <input checked="" type="radio"/> Disabled |
| Unicast Flood | <input type="radio"/> Enabled <input checked="" type="radio"/> Disabled |
| ACL | <input type="radio"/> Enabled <input checked="" type="radio"/> Disabled |
| Port Security Violation | <input type="radio"/> Enabled <input checked="" type="radio"/> Disabled |
| DHCP rate limit | <input type="radio"/> Enabled <input checked="" type="radio"/> Disabled |
| ARP rate limit | <input type="radio"/> Enabled <input checked="" type="radio"/> Disabled |

Figure 4-3-13 Error Disabled Recovery Page Screenshot

The page includes the following fields:

| Object | Description |
|----------------------------------|--|
| • Recovery Interval | The period (in seconds) for which a port will be kept disabled in the event of a port error is detected (and the port action shuts down the port). |
| • BPDU Guard | Enable or disable the port error disabled function to check status by BPDU guard. |
| • Self Loop | Enable or disable the port error disabled function to check status by self loop. |
| • Broadcast Flood | Enable or disable the port error disabled function to check status by broadcast flood. |
| • Unknown Multicast Flood | Enable or disable the port error disabled function to check status by unknown multicast flood. |
| • Unicast Flood | Enable or disable the port error disabled function to check status by unicast flood. |
| • ACL | Enable or disable the port error disabled function to check status by ACL. |
| • Port Security | Enable or disable the port error disabled function to check status by port security |

| | |
|--------------------------|---|
| Violation | violation. |
| • DHCP Rate Limit | Enable or disable the port error disabled function to check status by DHCP rate limit |
| • ARP Rate Limit | Enable or disable the port error disabled function to check status by ARP rate limit |

Buttons

Apply : Click to apply changes.

▼ **Error Disable Information**

| Information Name | Information Value |
|-------------------------|-------------------|
| Recovery Interval | 300 |
| BPDU Guard | disabled |
| Self Loop | disabled |
| Broadcast Flood | disabled |
| Unknown Multicast Flood | disabled |
| Unicast Flood | disabled |
| ACL | disabled |
| Port Security Violation | disabled |
| DHCP rate limit | disabled |
| ARP rate limit | disabled |

Figure 4-3-14 Error Disabled Information Page Screenshot

The page includes the following fields:

| Object | Description |
|----------------------------------|--|
| • Recovery Interval | Display the current recovery interval time |
| • BPDU Guard | Display the current BPDU guard status |
| • Self Loop | Display the current self loop status |
| • Broadcast Flood | Display the current broadcast flood status |
| • Unknown Multicast Flood | Display the current unknown multicast flood status |
| • Unicast Flood | Display the current unicast flood status |
| • ACL | Display the current ACL status |
| • Port Security Violation | Display the current port security violation status |
| • DHCP Rate Limit | Display the current DHCP rate limit status |
| • ARP Rate Limit | Display the current ARP rate limit status |

4.3.8 Port Error Disabled

This page provides disable that transitions a port into error disable and the recovery options. The ports were disabled by some protocols such as BPDU Guard, Loopback and UDLD. The Port Error Disable screen in [Figure 4-3-15](#) appears.

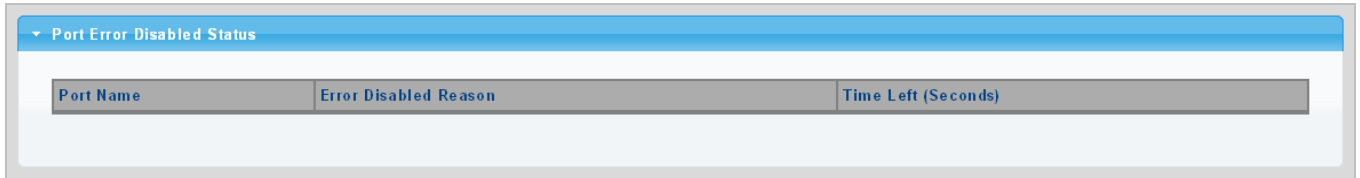

Figure 4-3-15 Port Error Disable Page Screenshot

The displayed counters are:

| Object | Description |
|-------------------------------|---|
| • Port Name | Display the port for error disable |
| • Error Disable Reason | Display the error disabled reason of the port |
| • Time Left (Seconds) | Display the time left |

4.3.9 Protected Ports

Overview

When a switch port is configured to be a member of protected group (also called Private VLAN), communication between protected ports within that group can be prevented. Two application examples are provided in this section:

- Customers connected to an ISP can be members of the protected group, but they are not allowed to communicate with each other within that VLAN.
- Servers in a farm of web servers in a Demilitarized Zone (DMZ) are allowed to communicate with the outside world and with database servers on the inside segment, but are not allowed to communicate with each other

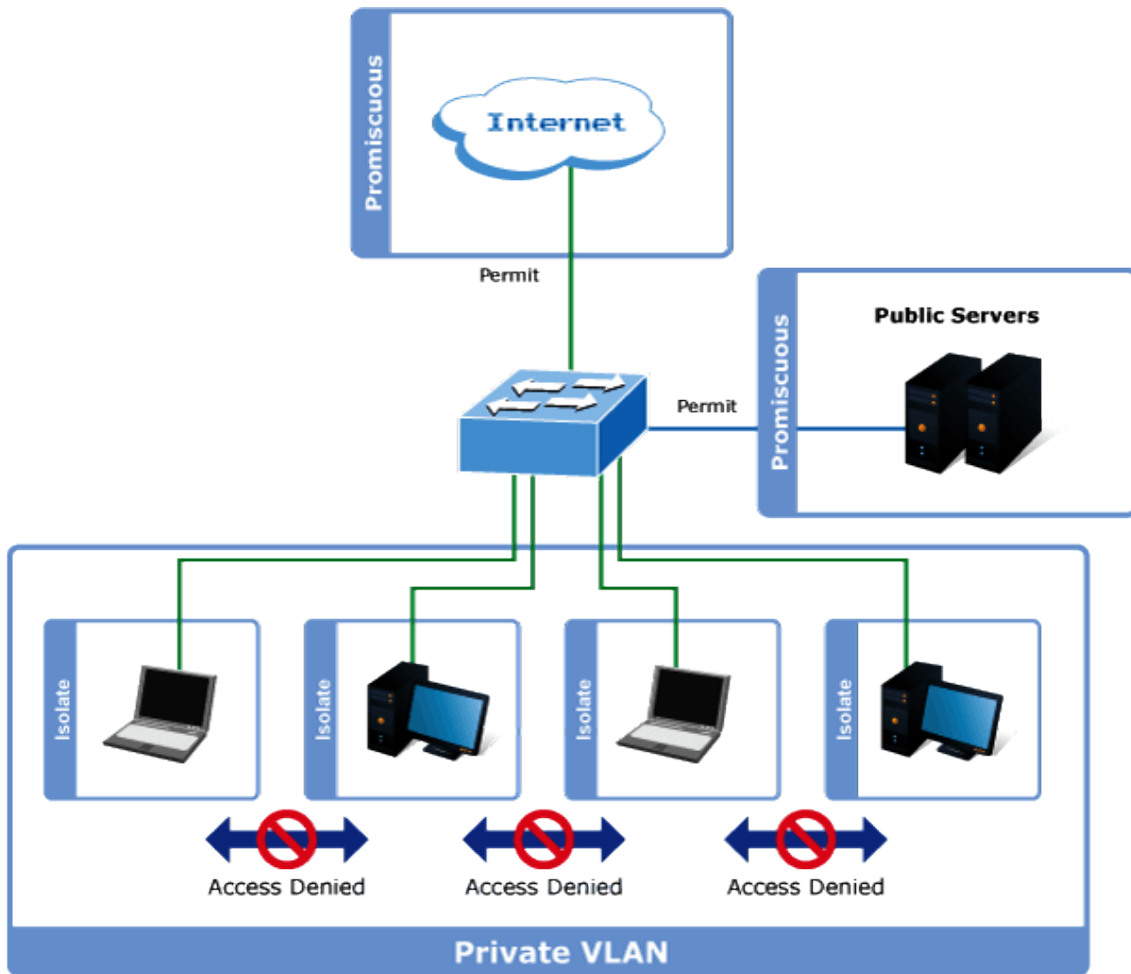

For protected port group to be applied, the LRP Managed Switch must first be configured for standard VLAN operation. Ports in a protected port group fall into one of these two groups:

- **Promiscuous (Unprotected) ports**

- Ports from which traffic can be forwarded to all ports in the private VLAN
- Ports which can receive traffic from all ports in the private VLAN

- **Isolated (Protected) ports**

- Ports from which traffic can only be forwarded to promiscuous ports in the private VLAN
- Ports which can receive traffic from only promiscuous ports in the private VLAN

The configuration of promiscuous and isolated ports applies to all private VLANs. When traffic comes in on a promiscuous port in a private VLAN, the VLAN mask from the VLAN table is applied. When traffic comes in on an isolated port, the private VLAN mask is applied in addition to the VLAN mask from the VLAN table. This reduces the ports to which forwarding can be done to just the promiscuous ports within the private VLAN.

The port settings relate to the currently unit, as reflected by the page header. The Port Isolation Configuration screens in [Figure 4-3-16](#) & [Figure 4-3-17](#) appear.

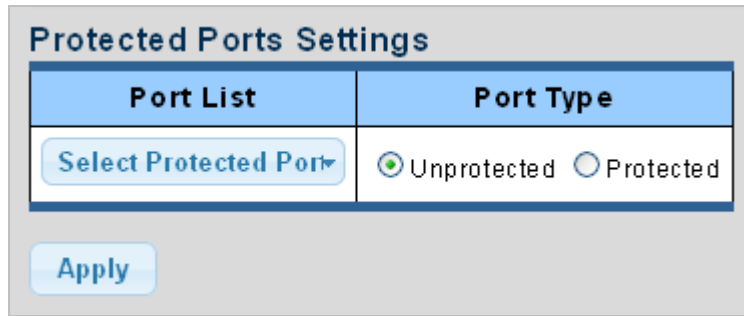



Figure 4-3-16 Protected Ports Settings Page Screenshot

The page includes the following fields:

| Object | Description |
|--|---|
| <ul style="list-style-type: none"> • Port List | Select port number from this drop-down list. |
| <ul style="list-style-type: none"> • Port Type | Displays protected port types. <ul style="list-style-type: none"> - Protected: A single stand-alone VLAN that contains one promiscuous port and one or more isolated (or host) ports. This VLAN conveys traffic between the isolated ports and a lone promiscuous port. - Unprotected: A promiscuous port can communicate with all the interfaces within a private VLAN. This is the default setting. |

Buttons

: Click to apply changes.

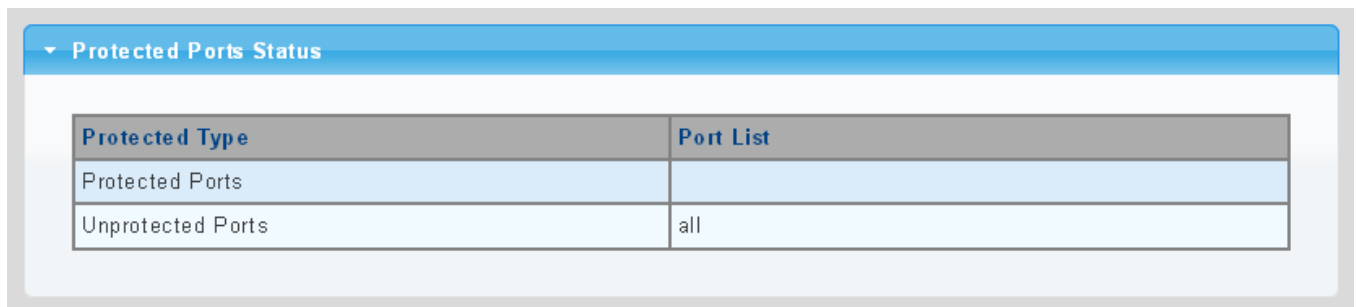

Figure 4-3-17 Port Isolation Status Page Screenshot

The page includes the following fields:

| Object | Description |
|--|---------------------------------------|
| <ul style="list-style-type: none"> • Protected Ports | Display the current protected ports |
| <ul style="list-style-type: none"> • Unprotected Ports | Display the current unprotected ports |

4.3.10 EEE

What is EEE

EEE is a power saving option that reduces the power usage when there is low or no traffic utilization. EEE works by powering down circuits when there is no traffic. When a port gets data to be transmitted all circuits are powered up. The time it takes to power up the circuits is named wakeup time. The default wakeup time is 17 us for 1Gbit links and 30 us for other link speeds.

EEE devices must agree upon the value of the wakeup time in order to make sure that both the receiving and transmitting device has all circuits powered up when traffic is transmitted. The devices can exchange wakeup time information using the LLDP protocol. EEE works for ports in auto-negotiation mode, where the port is negotiated to either 1G or 100 Mbit full duplex mode. For ports that are not EEE-capable the corresponding EEE checkboxes are grayed out and thus impossible to enable EEE for. The EEE port settings relate to the currently unit, as reflected by the page header.

When a port is powered down for saving power, outgoing traffic is stored in a buffer until the port is powered up again. Because there are some overhead in turning the port down and up, more power can be saved if the traffic can be buffered up until a large burst of traffic can be transmitted. Buffering traffic will give some latency in the traffic.

The EEE Port Settings screens in [Figure 4-3-18](#) & [Figure 4-3-19](#) appear.

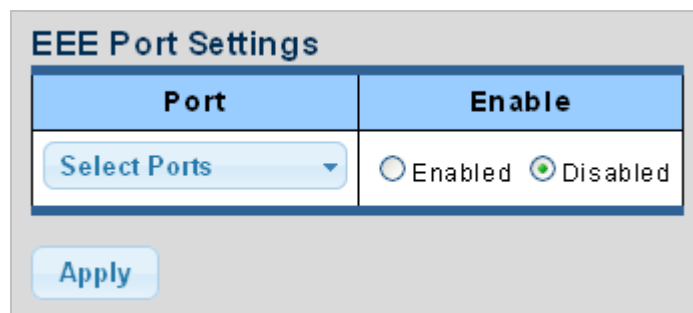

Figure 4-3-18 EEE Port Settings Page Screenshot

The page includes the following fields:

| Object | Description |
|----------|---|
| • Port | Select port number from this drop-down list |
| • Enable | Enable or disable the EEE function |

Buttons

: Click to apply changes.

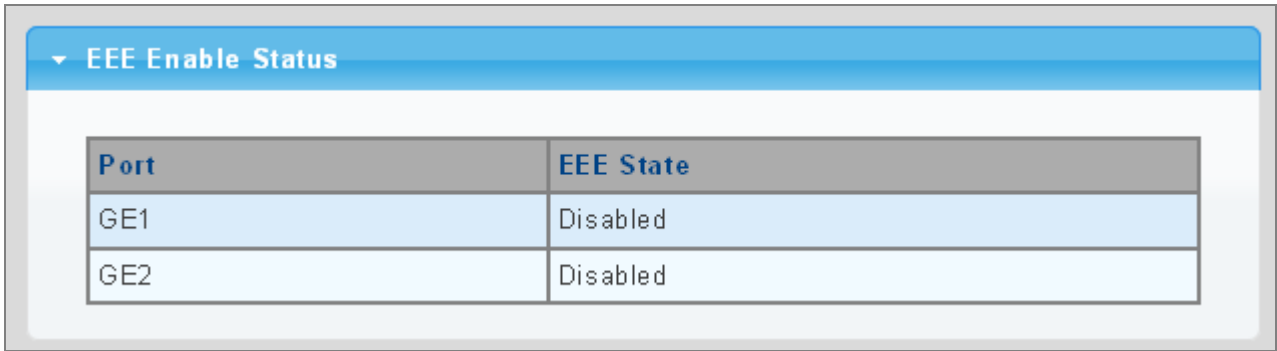

| EEE Enable Status | |
|-------------------|-----------|
| Port | EEE State |
| GE1 | Disabled |
| GE2 | Disabled |

Figure 4-3-19 EEE Enable Status Page Screenshot

The page includes the following fields:

| Object | Description |
|-------------|--|
| • Port | The switch port number of the logical port |
| • EEE State | Display the current EEE state |



EEE is available for GE1~GE2 only.

4.3.11 SFP Module Information

LRP Managed Switch has supported the SFP module with **digital diagnostics monitoring (DDM)** function, this feature is also known as digital optical monitoring (DOM). You can check the physical or operational status of an SFP module via the SFP Module Information Page. This Page shows the operational status, such as the transceiver type, speed, wavelength, optical output power, optical input power, temperature, laser bias current and transceiver supply voltage in real time. You can also use the hyperlink of port no. to check the statistics on a specific interface.

4.3.11.1 SFP Module Status

The SFP Module Status screens in [Figure 4-3-20](#) & [Figure 4-3-21](#) appear.

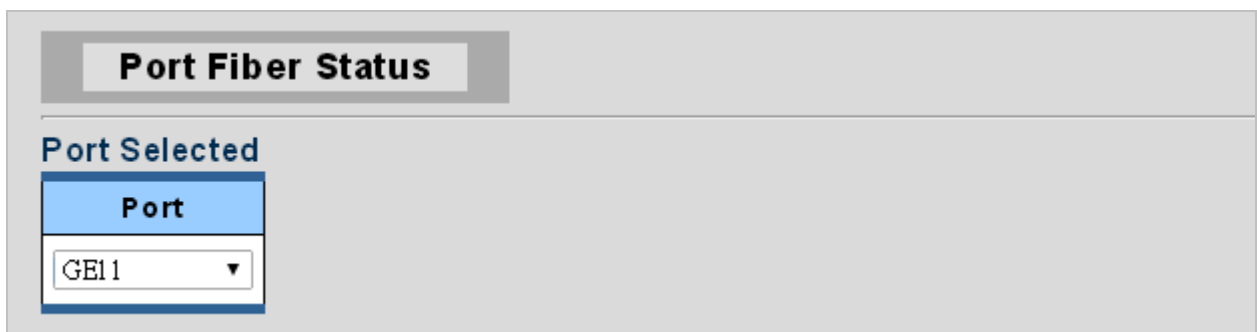

Figure 4-3-20 Port Selected Page Screenshot with Sample Switch

The page includes the following fields:

| Object | Description |
|--|---|
| <ul style="list-style-type: none"> • Port | Select port number from this drop-down list |



Figure 4-3-21 Fiber Port Status Page Screenshot

The page includes the following fields:

| Object | Description |
|--|------------------------------------|
| <ul style="list-style-type: none"> • OE-Present | Display the current SFP OE-present |
| <ul style="list-style-type: none"> • LOS | Display the current SFP LOS |

4.3.11.1 SFP Module Detail Status

The SFP Module Detail Status screen in [Figure 4-3-22](#) appears.

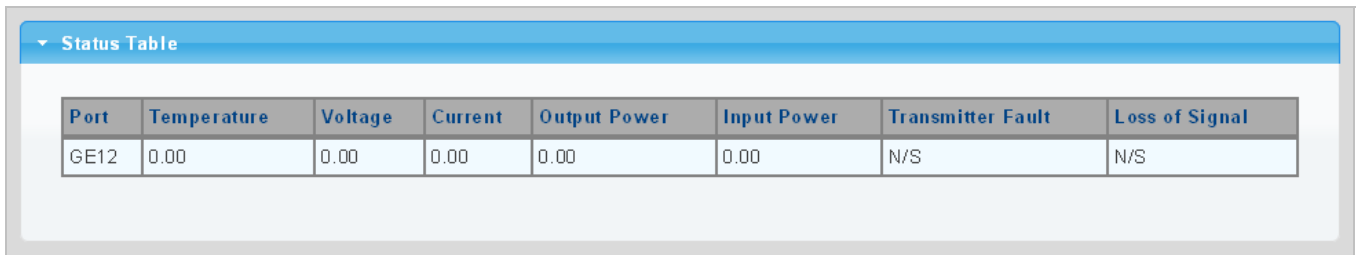

| Port | Temperature | Voltage | Current | Output Power | Input Power | Transmitter Fault | Loss of Signal |
|------|-------------|---------|---------|--------------|-------------|-------------------|----------------|
| GE12 | 0.00 | 0.00 | 0.00 | 0.00 | 0.00 | N/S | N/S |

Figure 4-3-22 SFP Module Detail Status Page Screenshot with Sample Switch

The page includes the following fields:

| Object | Description |
|-------------------------|---|
| • Port | The logical port for the settings contained in the same row |
| • Temperature | Display the current SFP temperature |
| • Voltage | Display the current SFP voltage |
| • Current | Display the current SFP current |
| • Output Power | Display the current SFP output power |
| • Input Power | Display the current SFP input power |
| • Transmit Fault | Display the current SFP transmit fault |
| • Loss of Signal | Display the current SFP loss of signal. |
| • Rate Ready | Display the current SFP rate ready. |

4.4 Link Aggregation

Port Aggregation optimizes port usage by linking a group of ports together to form a single Link Aggregated Groups (LAGs). Port Aggregation multiplies the bandwidth between the devices, increases port flexibility, and provides link redundancy.

Each LAG is composed of ports of the same speed, set to full-duplex operations. Ports in a LAG can be of different media types (UTP/Fiber, or different fiber types) provided they operate at the same speed.

Aggregated Links can be assigned manually (**Port Trunk**) or automatically by enabling Link Aggregation Control Protocol (**LACP**) on the relevant links.

Aggregated Links are treated by the system as a single logical port. Specifically, the Aggregated Link has similar port attributes to a non-aggregated port, including auto-negotiation, speed, duplex setting, etc.

The device supports the following Aggregation links :

- **Static LAGs (Port Trunk)** – Force aggregated selected ports to be a trunk group.
- **Link Aggregation Control Protocol (LACP)** LAGs - LACP LAG negotiate Aggregated Port links with other LACP ports located on a different device. If the other device ports are also LACP ports, the devices establish a LAG between them.

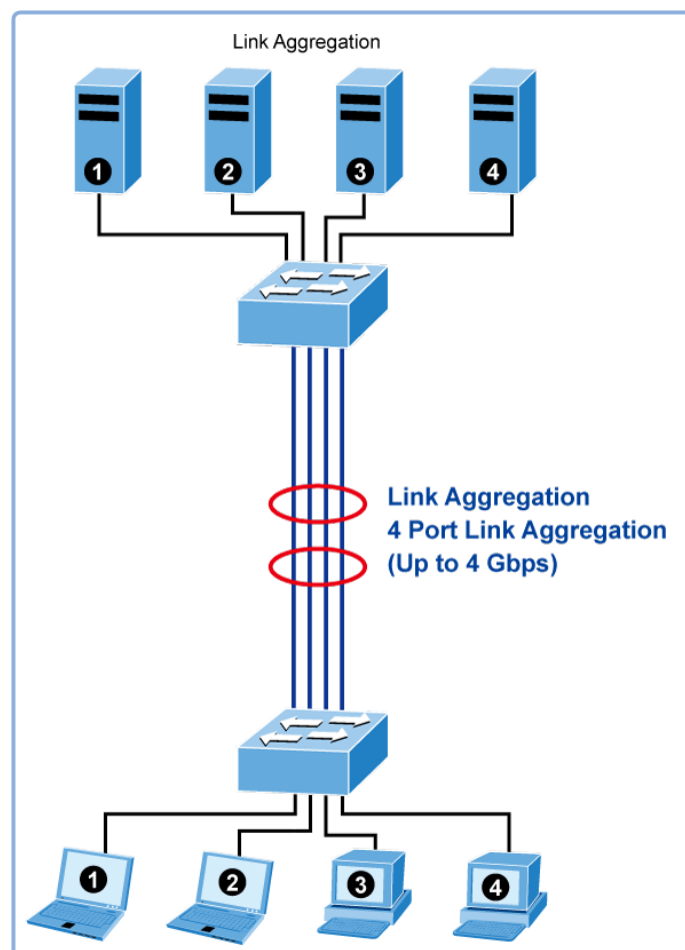

Figure 4-4-1 Link Aggregation

The **Link Aggregation Control Protocol (LACP)** provides a standardized means for exchanging information between Partner Systems that require high-speed redundant links. Link aggregation lets you group up to eight consecutive ports into a single dedicated connection. This feature can expand bandwidth to a device on the network. LACP operation requires full-duplex mode. For more detailed information, refer to the IEEE 802.3ad standard.

Port link aggregations can be used to increase the bandwidth of a network connection or to ensure fault recovery. Link aggregation lets you group up to 8 consecutive ports into a single dedicated connection between any two the Switch or other Layer 2 switches. However, before making any physical connections between devices, use the Link Aggregation Configuration menu to specify the link aggregation on the devices at both ends. When using a port link aggregation, note that:

- The ports used in a link aggregation must all be of the same media type (RJ45, 100 Mbps fiber).
- The ports that can be assigned to the same link aggregation have certain other restrictions (see below).
- Ports can only be assigned to one link aggregation.
- The ports at both ends of a connection must be configured as link aggregation ports.
- None of the ports in a link aggregation can be configured as a mirror source port or a mirror target port.
- All of the ports in a link aggregation have to be treated as a whole when moved from/to, added or deleted from a VLAN.
- The Spanning Tree Protocol will treat all the ports in a link aggregation as a whole.
- Enable the link aggregation prior to connecting any cable between the switches to avoid creating a data loop.
- Disconnect all link aggregation port cables or disable the link aggregation ports before removing a port link aggregation to avoid creating a data loop.

It allows a maximum of 8 ports to be aggregated at the same time. The LRP Managed Switch supports Gigabit Ethernet ports (up to 8 groups). If the group is defined as an LACP static link aggregation group, then any extra ports selected are placed in a standby mode for redundancy if one of the other ports fails. If the group is defined as a local static link aggregation group, then the number of ports must be the same as the group member ports.

Use the Link Aggregation Menu to display or configure the Trunk function. This section has the following items:

- | | |
|----------------------------|--|
| ■ LAG Setting | Configures load balance algorithm configuration settings |
| ■ LAG Management | Configures LAG configuration settings |
| ■ LAG Port Setting | Configures LAG port settings |
| ■ LACP Setting | Configures LACP priority settings |
| ■ LACP Port Setting | Configures LACP configuration settings |
| ■ LAG Status | Displays LAG status / LACP information |

4.4.1 LAG Setting

This page allows configuring load balance algorithm configuration settings. The LAG Setting screens in [Figure 4-4-2](#) & [Figure 4-4-3](#) appear.

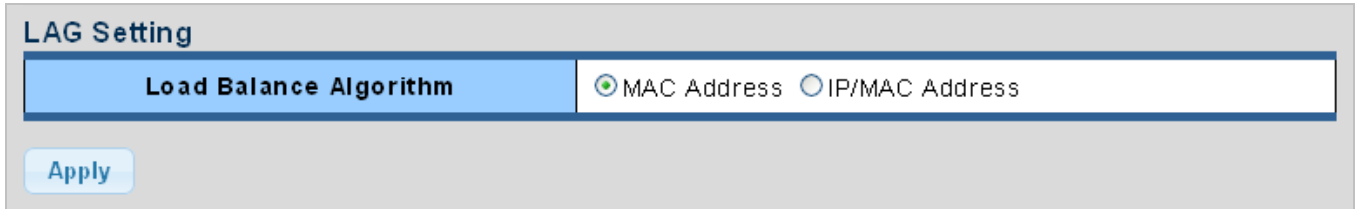

Figure 4-4-2 LAG Setting Page Screenshot

The page includes the following fields:

| Object | Description |
|---|--|
| <ul style="list-style-type: none"> • Load Balance Algorithm | Select load balance algorithm mode: <ul style="list-style-type: none"> ■ MAC Address: The MAC address can be used to calculate the port for the frame. ■ IP/MAC Address: The IP and MAC address can be used to calculate the port for the frame. |

Buttons



: Click to apply changes.

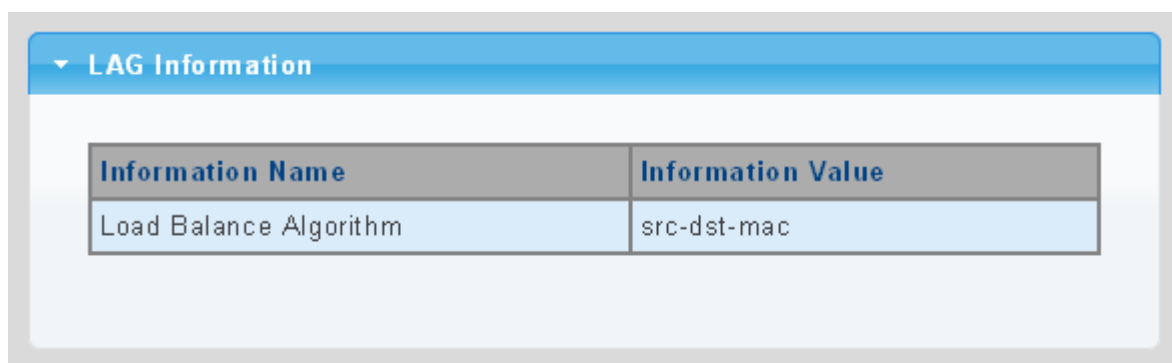

Figure 4-4-3 LAG Information Page Screenshot

The page includes the following fields:

| Object | Description |
|---|--|
| <ul style="list-style-type: none"> • Load Balance Algorithm | Display the current load balance algorithm |

4.4.2 LAG Management

This page is used to configure the LAG management. The LAG Management screens in [Figure 4-4-4](#) & [Figure 4-4-5](#) appear.

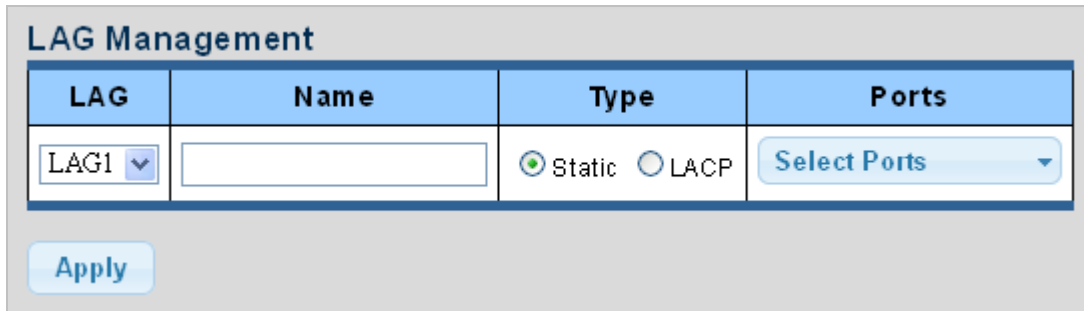
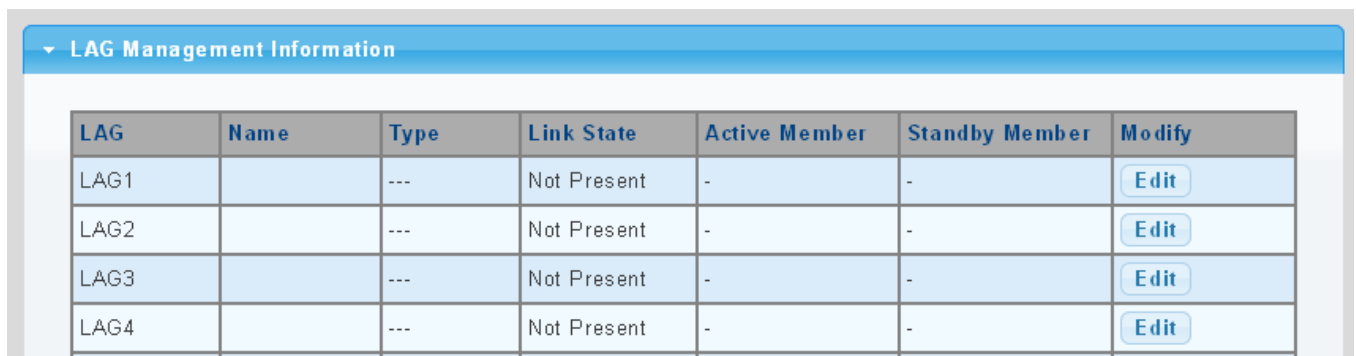

Figure 4-4-4 LAG Management Page Screenshot

The page includes the following fields:

| Object | Description |
|---------|--|
| • LAG | Select LAG number from this drop-down list |
| • Name | Indicates each LAG name |
| • Type | Indicates the trunk type Static: Force aggregated selected ports to be a trunk group. LACP: LACP LAG negotiate Aggregated Port links with other LACP ports located on a different device. If the other device ports are also LACP ports, the devices establish a LAG between them. |
| • Ports | Select port number from this drop-down list to establish Link Aggregation |



| LAG | Name | Type | Link State | Active Member | Standby Member | Modify |
|------|------|------|-------------|---------------|----------------|--------|
| LAG1 | | --- | Not Present | - | - | Edit |
| LAG2 | | --- | Not Present | - | - | Edit |
| LAG3 | | --- | Not Present | - | - | Edit |
| LAG4 | | --- | Not Present | - | - | Edit |

Figure 4-4-5 LAG Management Information Page Screenshot

The page includes the following fields:

| Object | Description |
|--------|--|
| • LAG | The LAG for the settings contained in the same row |
| • Name | Display the current name |
| • Type | Display the current type |

| | |
|-------------------------|---|
| • Link State | Display the link state |
| • Active Member | Display the active member |
| • Standby Member | Display the standby member |
| • Modify | Click  to modify LAG configuration |

4.4.3 LAG Port Setting

This page allows setting configuration for each LAG. The LAG Port Setting screens in [Figure 4-4-6](#) & [Figure 4-4-7](#) appear.

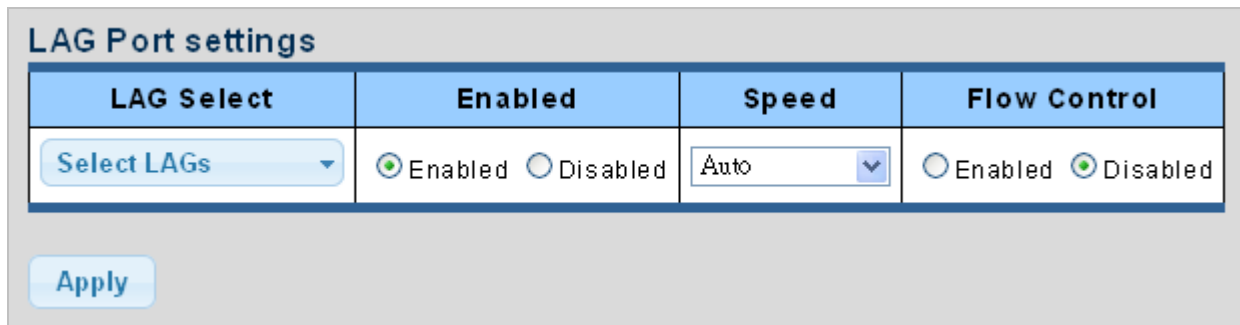

Figure 4-4-6 LAG Port Setting Information Page Screenshot

The page includes the following fields:

| Object | Description |
|-----------------------|--|
| • LAG Select | Select LAG number from this drop-down list. |
| • Enable | Indicates the LAG state operation. Possible states are: Enabled - Start up the LAG manually. Disabled - Shut down the LAG manually. |
| • Speed | Select any available link speed for the given switch port. Draw the menu bar to select the mode. <ul style="list-style-type: none"> ■ Auto - Set up Auto negotiation. ■ Auto-10M - Set up 10M Auto negotiation. ■ Auto-100M - Set up 100M Auto negotiation. ■ Auto-1000M - Set up 1000M Auto negotiation. ■ Auto-10/100M - Set up 10/100M Auto negotiation. ■ 10M - Set up 10M Force mode. ■ 100M - Set up 100M Force mode. ■ 1000M - Set up 1000M Force mode. |
| • Flow Control | When Auto Speed is selected for a port, this section indicates the flow control capability that is advertised to the link partner. When a fixed-speed setting is selected, that is what is used. The current RX column indicates whether pause frames on the port are obeyed. The current TX column indicates whether pause |

frames on the port are transmitted. The RX and TX settings are determined by the result of the last Auto-Negotiation. Check the configured column to use flow control. This setting is related to the setting for Configured Link Speed.

Buttons



: Click to apply changes.

LAG Port Status

| LAG | Description | Port Type | Enable State | Link Status | Speed | Duplex | FlowCtrl Config | FlowCtrl Status |
|------|-------------|-----------|--------------|-------------|-------|--------|-----------------|-----------------|
| LAG1 | | | Enabled | | Auto | Auto | Disabled | Disabled |
| LAG2 | | | Enabled | | Auto | Auto | Disabled | Disabled |
| LAG3 | | | Enabled | | Auto | Auto | Disabled | Disabled |
| LAG4 | | | Enabled | | Auto | Auto | Disabled | Disabled |

Figure 4-4-7 LAG Port Status Page Screenshot

The page includes the following fields:

| Object | Description |
|-----------------------|--|
| • LAG | The LAG for the settings contained in the same row |
| • Description | Display the current description |
| • Port Type | Display the current port type |
| • Enable State | Display the current enable state |
| • Speed | Display the current speed |
| • Duplex | Display the current duplex mode |
| • Flow Control Config | Display the current flow control configuration |
| • Flow Control Status | Display the current flow control status |



LACP is available for GE1~GE4.

4.4.4 LACP Setting

This page is used to configure the LACP system priority setting. The LACP Setting screens in [Figure 4-4-8](#) & [Figure 4-4-9](#) appear.

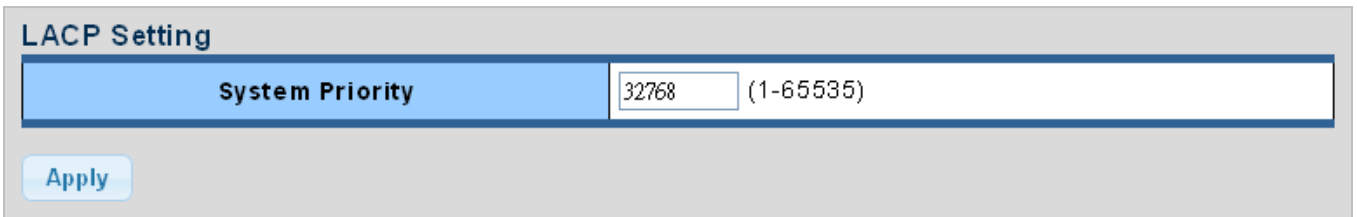



Figure 4-4-8 LACP Setting Page Screenshot

The page includes the following fields:

| Object | Description |
|--|--|
| <ul style="list-style-type: none"> • System Priority | A value which is used to identify the active LACP. The LRP Managed Switch with the lowest value has the highest priority and is selected as the active LACP peer of the trunk group. |

Buttons

 : Click to apply changes.

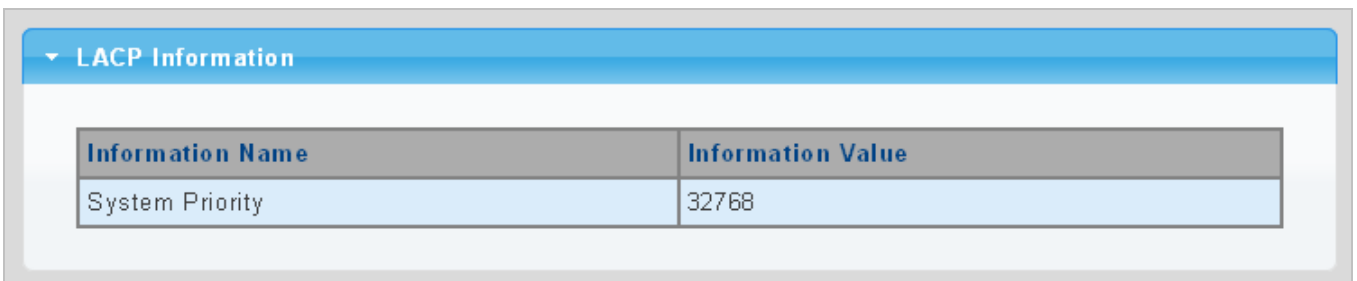

Figure 4-4-9 LACP Information Page Screenshot

The page includes the following fields:

| Object | Description |
|--|--------------------------------------|
| <ul style="list-style-type: none"> • System Priority | Display the current system priority. |

4.4.5 LACP Port Setting

This page is used to configure the LACP port setting. The LACP Port Setting screens in [Figure 4-4-10](#) & [Figure 4-4-11](#) appear.

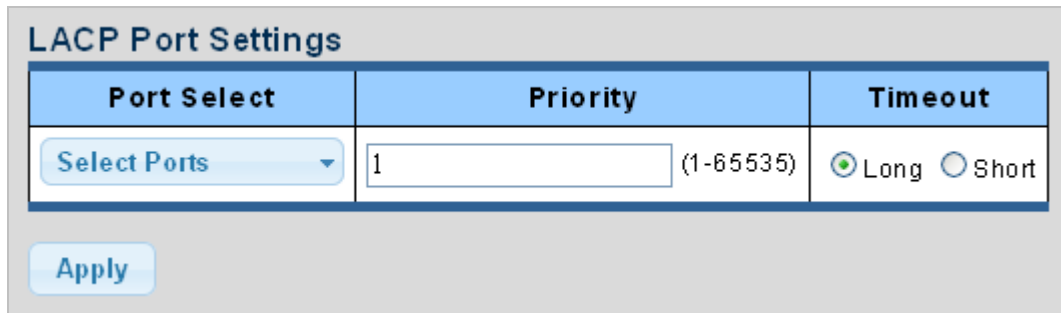

| Port Select | Priority | Timeout |
|--------------|-------------|---|
| Select Ports | 1 (1-65535) | <input checked="" type="radio"/> Long <input type="radio"/> Short |

Apply

Figure 4-4-10 LACP Port Setting Page Screenshot

The page includes the following fields:

| Object | Description |
|---|--|
| <ul style="list-style-type: none"> • Port Select | Select port number from this drop-down list to set LACP port setting. |
| <ul style="list-style-type: none"> • Priority | <p>The Priority controls the priority of the port. If the LACP partner wants to form a larger group than is supported by this device, then this parameter will control which ports will be active and which ports will be in a backup role.</p> <p>Lower number means greater priority.</p> |
| <ul style="list-style-type: none"> • Timeout | The Timeout controls the period between BPDU transmissions. Short will transmit LACP packets each second, while Long will wait for 30 seconds before sending an LACP packet. |

Buttons

: Click to apply changes.

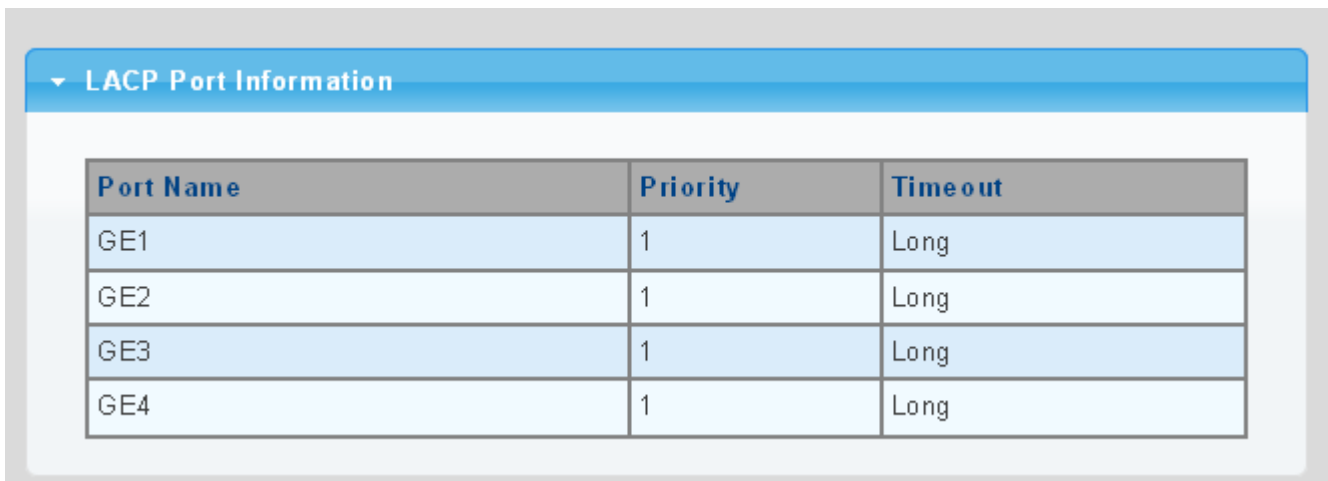

| Port Name | Priority | Time out |
|-----------|----------|----------|
| GE1 | 1 | Long |
| GE2 | 1 | Long |
| GE3 | 1 | Long |
| GE4 | 1 | Long |

Figure 4-4-11 LACP Port Information Page Screenshot

The page includes the following fields:

| Object | Description |
|-------------|---|
| • Port Name | The switch port number of the logical port |
| • Priority | Display the current LACP priority parameter |
| • Timeout | Display the current timeout parameter |

4.4.6 LAG Status

This page displays LAG status. The LAG Status screens in [Figure 4-4-12](#) & [Figure 4-4-13](#) appear.

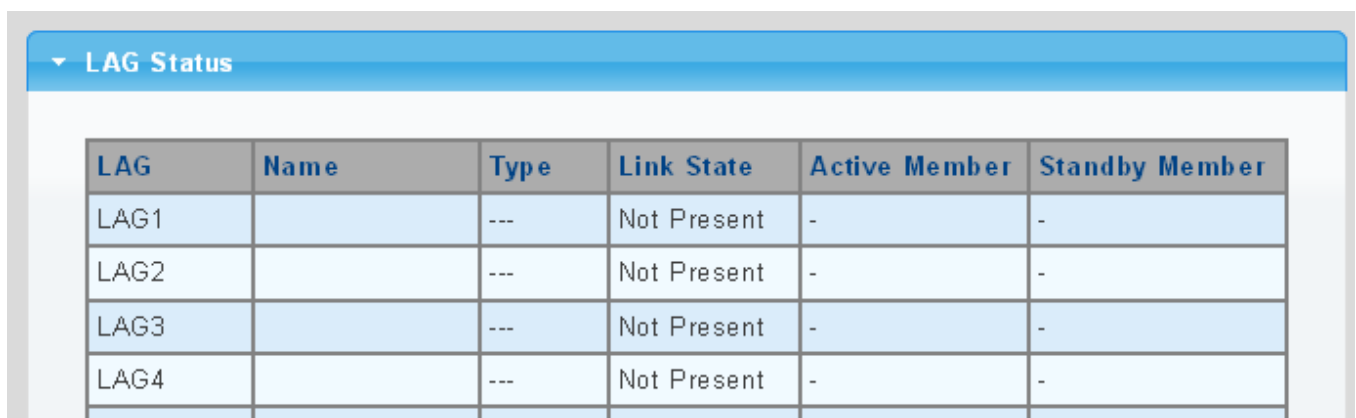

| LAG | Name | Type | Link State | Active Member | Standby Member |
|------|------|------|-------------|---------------|----------------|
| LAG1 | | --- | Not Present | - | - |
| LAG2 | | --- | Not Present | - | - |
| LAG3 | | --- | Not Present | - | - |
| LAG4 | | --- | Not Present | - | - |

Figure 4-4-12 LAG Status Page Screenshot

The page includes the following fields:

| Object | Description |
|------------------|------------------------------------|
| • LAG | Display the current trunk entry |
| • Name | Display the current LAG name |
| • Type | Display the current trunk type |
| • Link State | Display the current link state |
| • Active Member | Display the current active member |
| • Standby Member | Display the current standby member |

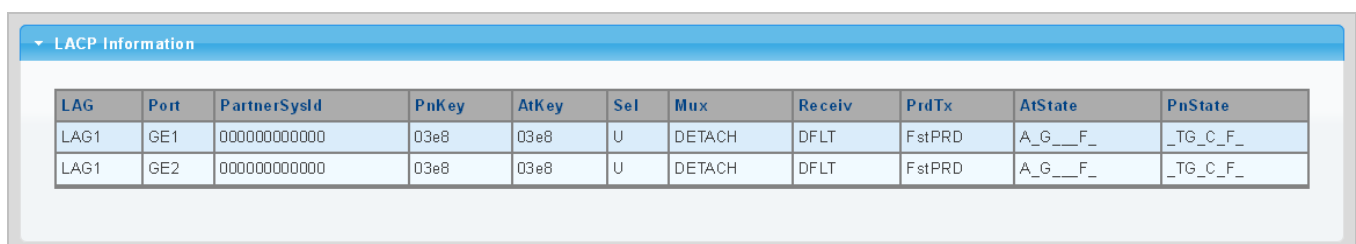

| LAG | Port | PartnerSysId | PnKey | AtKey | Sel | Mux | Receiv | PrdTx | AtState | PnState |
|------|------|--------------|-------|-------|-----|--------|--------|--------|---------|----------|
| LAG1 | GE1 | 000000000000 | 03e8 | 03e8 | U | DETACH | DFLT | FstPRD | A_G__F_ | _TG_C_F_ |
| LAG1 | GE2 | 000000000000 | 03e8 | 03e8 | U | DETACH | DFLT | FstPRD | A_G__F_ | _TG_C_F_ |

Figure 4-4-13 LACP Information Page Screenshot

The page includes the following fields:

| Object | Description |
|-----------------------|---|
| • Trunk | Display the current trunk ID |
| • Port | Display the current port number |
| • PartnerSysId | The system ID of link partner. This field would be updated when the port receives LACP PDU from link partner |
| • PnKey | Port key of partner. This field would be updated when the port receives LACP PDU from link partner |
| • AtKey | Port key of actor. The key is designed to be the same as trunk ID. |
| • Sel | LACP selection logic status of the port <ul style="list-style-type: none"> ■ "S" means selected ■ "U" means unselected ■ "D" means standby |
| • Mux | LACP mux state machine status of the port <ul style="list-style-type: none"> ■ "DETACH" means the port is in detached state ■ "WAIT" means waiting state ■ "ATTACH" means attach state ■ "CLLCT" means collecting state ■ "DSTRBT" means distributing state |
| • Receiv | LACP receive state machine status of the port <ul style="list-style-type: none"> ■ "INIT" means the port is in initialize state ■ "PORTds" means port disabled state ■ "EXPR" means expired state ■ "LACPds" means LACP disabled state ■ "DFLT" means defaulted state ■ "CRRNT" means current state |
| • PrdTx | LACP periodic transmission state machine status of the port <ul style="list-style-type: none"> ■ "no PRD" means the port is in no periodic state ■ "FstPRD" means fast periodic state ■ "SlwPRD" means slow periodic state ■ "PrdTX" means periodic TX state |
| • AtState | The actor state field of LACP PDU description. The field from left to right describes: "LACP_Activity", "LACP_Timeout", "Aggregation", "Synchronization", "Collecting", "Distributing", "Defaulted", and "Expired". The contents could be true or false. If the contents are false, the web shows "_"; if the contents are true, the web shows "A", "T", "G", "S", "C", "D", "F" and "E" for each content respectively. |
| • PnState | The partner state field of LACP PDU description. The field from left to right describes: "LACP_Activity", "LACP_Timeout", "Aggregation", "Synchronization", "Collecting", "Distributing", "Defaulted", and |

"Expired".

The contents could be true or false. If the contents are false, the web will show "_"; if the contents are true, the Web shows "A", "T", "G", "S", "C", "D", "F" and "E" for each content respectively.

4.5 VLAN

4.5.1 VLAN Overview

A **Virtual Local Area Network (VLAN)** is a network topology configured according to a logical scheme rather than the physical layout. VLAN can be used to combine any collection of LAN segments into an autonomous user group that appears as a single LAN. VLAN also logically segment the network into different broadcast domains so that packets are forwarded only between ports within the VLAN. Typically, a VLAN corresponds to a particular subnet, although not necessarily.

VLAN can enhance performance by conserving bandwidth, and improve security by limiting traffic to specific domains.

A VLAN is a collection of end nodes grouped by logic instead of physical location. End nodes that frequently communicate with each other are assigned to the same VLAN, regardless of where they are physically on the network. Logically, a VLAN can be equated to a broadcast domain, because broadcast packets are forwarded to only members of the VLAN on which the broadcast was initiated.

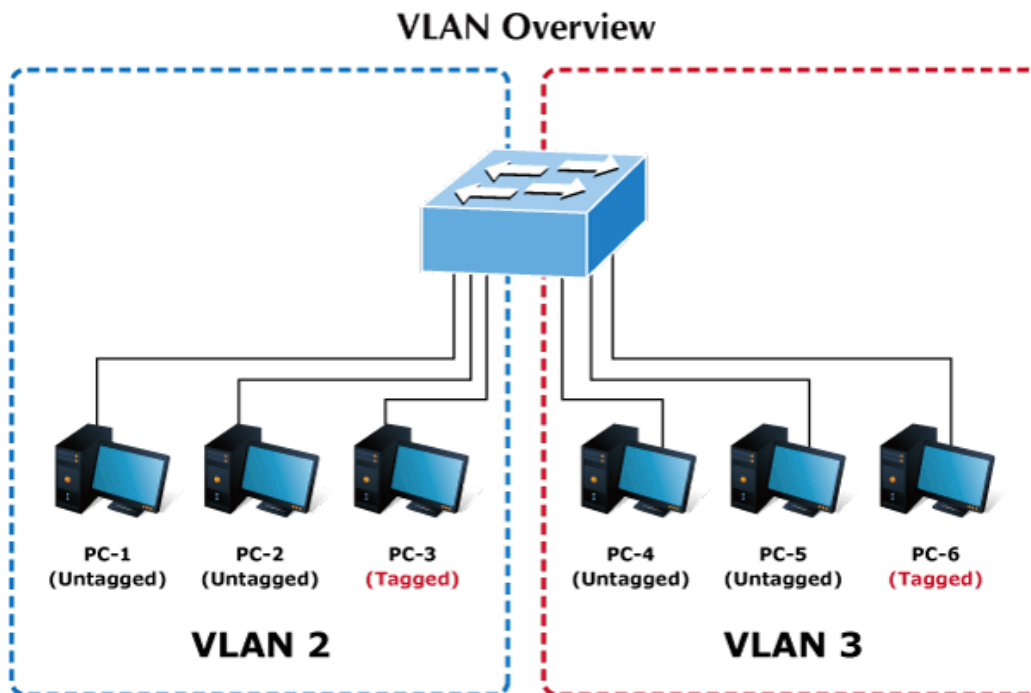

1. No matter what basis is used to uniquely identify end nodes and assign these nodes VLAN membership, packets cannot cross VLAN without a network device performing a routing function between the VLAN.
2. The LRP Managed Switch supports IEEE 802.1Q VLAN. The port untagging function can be used to remove the 802.1 tag from packet headers to maintain compatibility with devices that are tag-unaware.
3. The LRP Managed Switch's default is to assign all ports to a single 802.1Q VLAN named DEFAULT_VLAN. As new VLAN is created, the member ports assigned to the new VLAN will be removed from the DEFAULT_VLAN port member list. The DEFAULT_VLAN has a VID = 1.



This section has the following items:

- **Management VLAN** Configures the management VLAN
- **Create VLAN** Creates the VLAN group
- **Interface Settings** Configures mode and PVID on the VLAN port
- **Port to VLAN** Configures the VLAN membership
- **Port VLAN Membership** Displays the VLAN membership
- **Protocol VLAN Group Setting** Configures the protocol VLAN group
- **Protocol VLAN Port Setting** Configures the protocol VLAN port setting
- **GVRP Setting** Configures GVRP global setting
- **GVRP Port Setting** Configures GVRP port setting
- **GVRP VLAN** Displays the GVRP VLAN database
- **GVRP Statistics** Displays the GVRP port statistics

4.5.2 IEEE 802.1Q VLAN

In large networks, routers are used to isolate broadcast traffic for each subnet into separate domains. This LRP Managed Switch provides a similar service at Layer 2 by using VLANs to organize any group of network nodes into separate broadcast domains. VLANs confine broadcast traffic to the originating group, and can eliminate broadcast storms in large networks. This also provides a more secure and cleaner network environment.

An IEEE 802.1Q VLAN is a group of ports that can be located anywhere in the network, but communicate as though they belong to the same physical segment.

VLANs help to simplify network management by allowing you to move devices to a new VLAN without having to change any physical connections. VLANs can be easily organized to reflect departmental groups (such as Marketing or R&D), usage groups (such as e-mail), or multicast groups (used for multimedia applications such as videoconferencing).

VLANs provide greater network efficiency by reducing broadcast traffic, and allow you to make network changes without having to update IP addresses or IP subnets. VLANs inherently provide a high level of network security since traffic must pass through a configured Layer 3 link to reach a different VLAN.

This LRP Managed Switch supports the following VLAN features:

- Up to 255 VLANs based on the IEEE 802.1Q standard
- Port overlapping, allowing a port to participate in multiple VLANs
- End stations can belong to multiple VLANs
- Passing traffic between VLAN-aware and VLAN-unaware devices

IEEE 802.1Q Standard

IEEE 802.1Q (tagged) VLAN are implemented on the Switch. 802.1Q VLAN require tagging, which enables them to span the entire network (assuming all switches on the network are IEEE 802.1Q-compliant).

VLAN allow a network to be segmented in order to reduce the size of broadcast domains. All packets entering a VLAN will only be forwarded to the stations (over IEEE 802.1Q enabled switches) that are members of that VLAN, and this includes broadcast, multicast and unicast packets from unknown sources.

VLAN can also provide a level of security to your network. IEEE 802.1Q VLAN will only deliver packets between stations that are members of the VLAN. Any port can be configured as either **tagging** or **untagging**:

- The untagging feature of IEEE 802.1Q VLAN allows VLAN to work with legacy switches that don't recognize VLAN tags in packet headers.
- The tagging feature allows VLAN to span multiple 802.1Q-compliant switches through a single physical connection and allows Spanning Tree to be enabled on all ports and work normally.

Some relevant terms:

- **Tagging** - The act of putting 802.1Q VLAN information into the header of a packet.
- **Untagging** - The act of stripping 802.1Q VLAN information out of the packet header.

802.1Q VLAN Tags

The figure below shows the 802.1Q VLAN tag. There are four additional octets inserted after the source MAC address. Their presence is indicated by a value of **0x8100** in the Ether Type field. When a packet's Ether Type field is equal to 0x8100, the packet carries the IEEE 802.1Q/802.1p tag. The tag is contained in the following two octets and consists of 3 bits of user priority, 1 bit of Canonical Format Identifier (CFI - used for encapsulating Token Ring packets so they can be carried across Ethernet backbones), and 12 bits of **VLAN ID (VID)**. The 3 bits of user priority are used by 802.1p. The VID is the VLAN identifier and is used by the 802.1Q standard. Because the VID is 12 bits long, 4094 unique VLAN can be identified.

The tag is inserted into the packet header making the entire packet longer by 4 octets. All of the information originally contained in the packet is retained.

802.1Q Tag

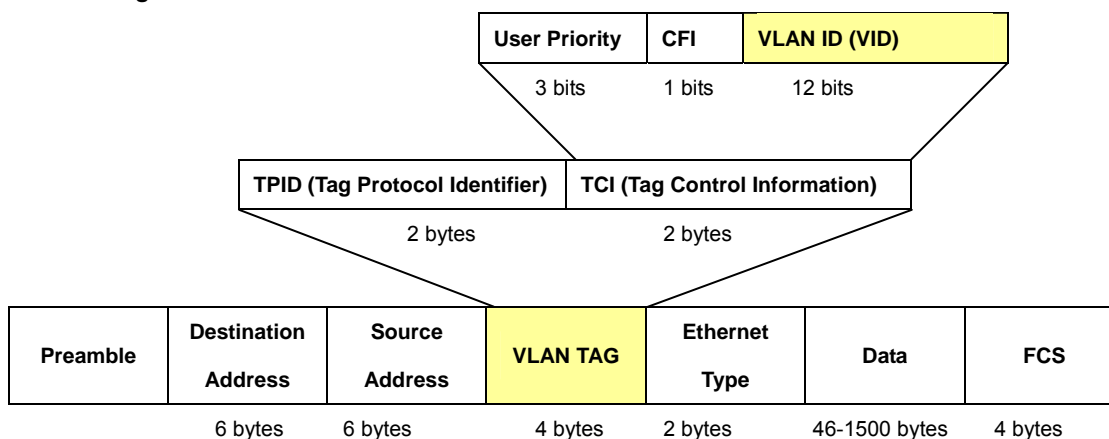

The Ether Type and VLAN ID are inserted after the MAC source address, but before the original Ether Type/Length or Logical Link Control. Because the packet is now a bit longer than it was originally, the Cyclic Redundancy Check (CRC) must be recalculated.

Adding an IEEE802.1Q Tag

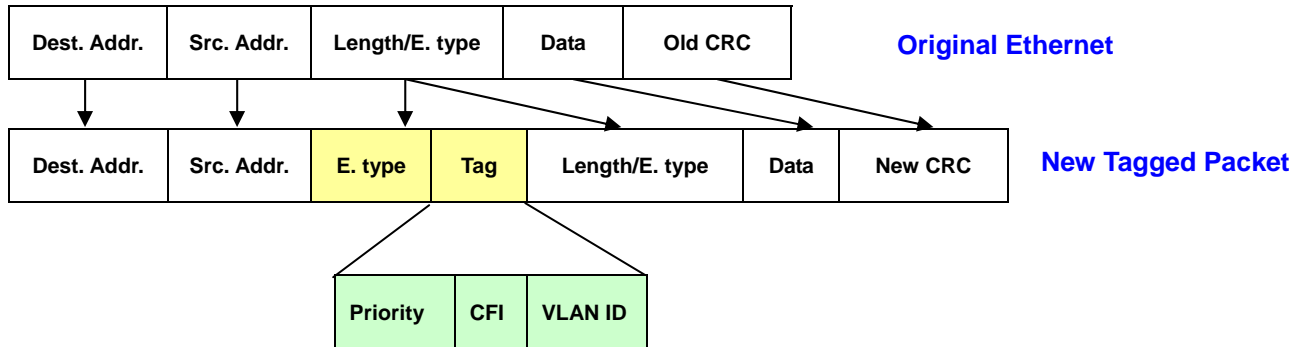

■ Port VLAN ID

Packets that are tagged (are carrying the 802.1Q VID information) can be transmitted from one 802.1Q compliant network device to another with the VLAN information intact. This allows 802.1Q VLAN to span network devices (and indeed, the entire network – if all network devices are 802.1Q compliant).

Every physical port on a switch has a PVID. 802.1Q ports are also assigned a PVID, for use within the switch. If no VLAN are defined on the switch, all ports are then assigned to a default VLAN with a PVID equal to 1. Untagged packets are assigned the PVID of the port on which they were received. Forwarding decisions are based upon this PVID, in so far as VLAN are concerned. Tagged packets are forwarded according to the VID contained within the tag. Tagged packets are also assigned a PVID, but the PVID is not used to make packet forwarding decisions, the VID is.

Tag-aware switches must keep a table to relate PVID within the switch to VID on the network. The switch will compare the VID of a packet to be transmitted to the VID of the port that is to transmit the packet. If the two VID are different the switch will drop the packet. Because of the existence of the PVID for untagged packets and the VID for tagged packets, tag-aware and tag-unaware network devices can coexist on the same network.

A switch port can have only one PVID, but can have as many VID as the switch has memory in its VLAN table to store them.

Because some devices on a network may be tag-unaware, a decision must be made at each port on a tag-aware device before packets are transmitted – should the packet to be transmitted have a tag or not? If the transmitting port is connected to a tag-unaware device, the packet should be untagged. If the transmitting port is connected to a tag-aware device, the packet should be tagged.

■ Default VLANs

The Switch initially configures one VLAN, VID = 1, called "**default**." The factory default setting assigns all ports on the Switch to the "**default**". As new VLAN are configured in Port-based mode, their respective member ports are removed from the "**default**."

■ Assigning Ports to VLANs

Before enabling VLANs for the switch, you must first assign each port to the VLAN group(s) in which it will participate. By default all ports are assigned to VLAN 1 as untagged ports. Add a port as a tagged port if you want it to carry traffic for one or more VLANs, and any intermediate network devices or the host at the other end of the connection supports VLANs. Then assign ports on the other VLAN-aware network devices along the path that will carry this traffic to the same VLAN(s), either manually or dynamically using GVRP. However, if you want a port on this switch to participate in one or more VLANs, but none of the intermediate network devices nor the host at the other end of the connection supports VLANs, then you should add this port to the VLAN as an untagged port.



VLAN-tagged frames can pass through VLAN-aware or VLAN-unaware network interconnection devices, but the VLAN tags should be stripped off before passing it on to any end-node host that does not support VLAN tagging.

■ VLAN Classification

When the switch receives a frame, it classifies the frame in one of two ways. If the frame is untagged, the switch assigns the frame to an associated VLAN (based on the default VLAN ID of the receiving port). But if the frame is tagged, the switch uses the tagged VLAN ID to identify the port broadcast domain of the frame.

■ Port Overlapping

Port overlapping can be used to allow access to commonly shared network resources among different VLAN groups, such as file servers or printers. Note that if you implement VLANs which do not overlap, but still need to communicate, you can connect them by enabled routing on this switch.

■ Untagged VLANs

Untagged (or static) VLANs are typically used to reduce broadcast traffic and to increase security. A group of network users assigned to a VLAN form a broadcast domain that is separate from other VLANs configured on the switch. Packets are forwarded only between ports that are designated for the same VLAN. Untagged VLANs can be used to manually isolate user groups or subnets.

4.5.3 Management VLAN

Configure Management VLAN on this page. The screens in [Figure 4-5-1](#) & [Figure 4-5-2](#) appear.

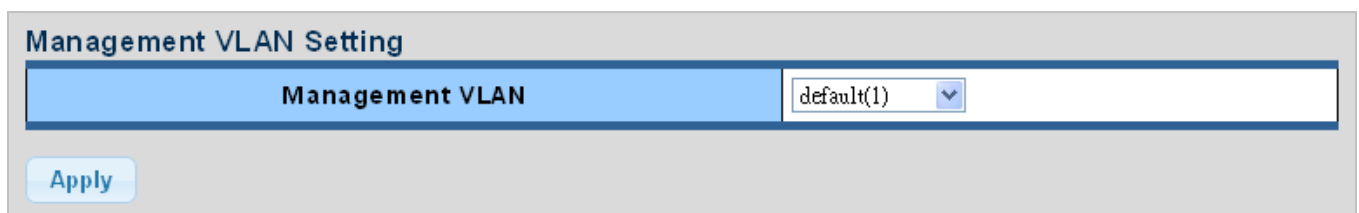

| Management VLAN Setting | |
|--------------------------------------|--------------|
| Management VLAN | default(1) ▼ |
| <input type="button" value="Apply"/> | |

Figure 4-5-1 Management VLAN Setting Page Screenshot

The page includes the following fields:

| Object | Description |
|-------------------|-----------------------------|
| • Management VLAN | Provide the managed VLAN ID |

Buttons

Apply : Click to apply changes.

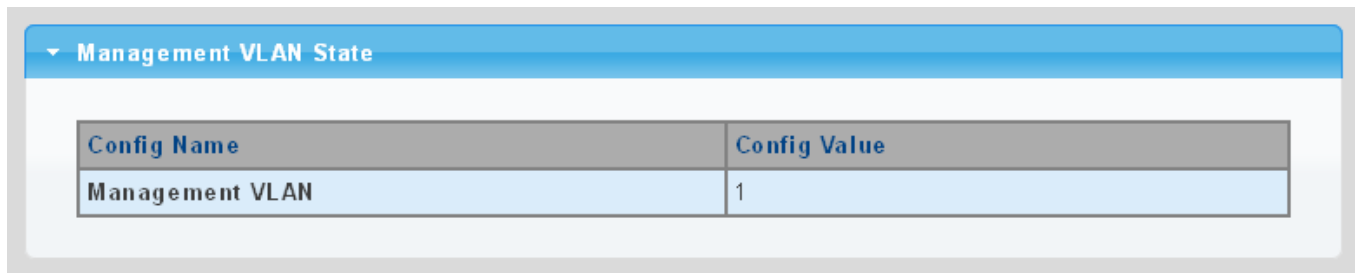

Figure 4-5-2 Management VLAN State Page Screenshot

The page includes the following fields:

| Object | Description |
|-------------------|--------------------------------------|
| • Management VLAN | Display the current management VLAN. |

4.5.4 Create VLAN

Create/delete VLAN on this page. The screens in [Figure 4-5-3](#) & [Figure 4-5-4](#) appear.

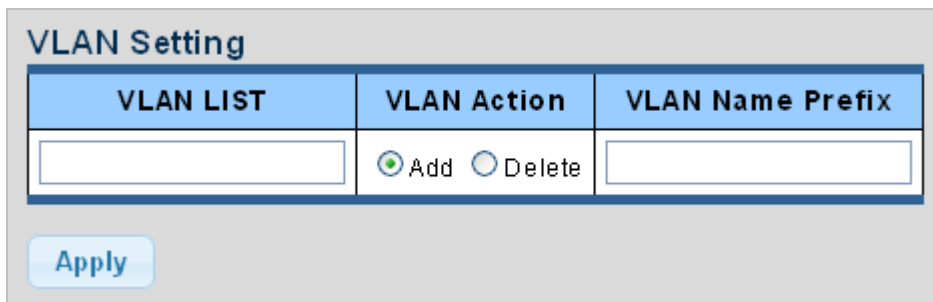



Figure 4-5-3 VLAN Setting Page Screenshot

The page includes the following fields:

| Object | Description |
|--------------------|---|
| • VLAN List | Indicates the ID of this particular VLAN. |
| • VLAN Action | This column allows users to add or delete VLAN s. |
| • VLAN Name Prefix | Indicates the name of this particular VLAN. |

Buttons

: Click to apply changes.

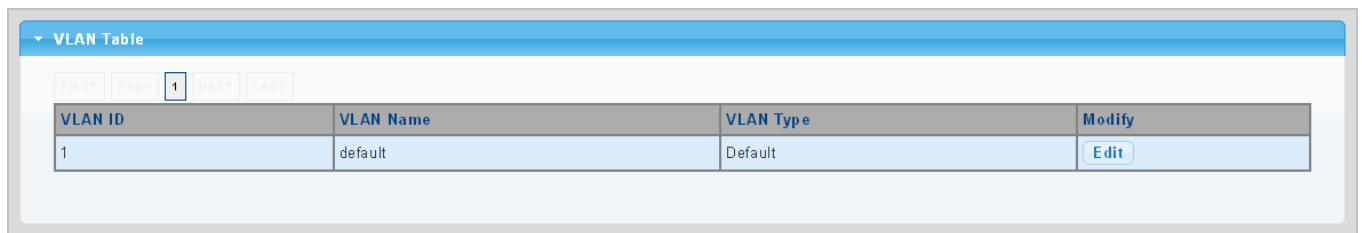



Figure 4-5-4 VLAN Table Page Screenshot

The page includes the following fields:

| Object | Description |
|-------------|--|
| • VLAN ID | Display the current VLAN ID entry |
| • VLAN Name | Display the current VLAN ID name |
| • VLAN Type | Display the current VLAN ID type |
| • Modify | Click  to modify VLAN configuration |

4.5.5 Interface Settings

This page is used for configuring the LRP Managed Switch port VLAN. The VLAN per Port Configuration Page contains fields for managing ports that are part of a VLAN. The port **default VLAN ID (PVID)** is configured on the VLAN Port Configuration Page. All untagged packets arriving to the device are tagged by the ports PVID.

Understand nomenclature of the Switch

■ IEEE 802.1Q Tagged and Untagged

Every port on an 802.1Q compliant switch can be configured as tagged or untagged.

- **Tagged:** Ports with tagging enabled will put the VID number, priority and other VLAN information into the header of all packets that flow into those ports. If a packet has previously been tagged, the port will not alter the packet, thus keeping the VLAN information intact. The VLAN information in the tag can then be used by other 802.1Q compliant devices on the network to make packet-forwarding decisions.
- **Untagged:** Ports with untagging enabled will strip the 802.1Q tag from all packets that flow into those ports. If the packet doesn't have an 802.1Q VLAN tag, the port will not alter the packet. Thus, all packets received by and forwarded by an untagging port will have no 802.1Q VLAN information. (Remember that the PVID is only used internally within the Switch). Untagging is used to send packets from an 802.1Q-compliant network device to a non-compliant network device.

| Frame Income / Frame Leave | Income Frame is tagged | Income Frame is untagged |
|----------------------------|-------------------------------|---------------------------------|
| Leave port is tagged | Frame remains tagged | Tag is inserted |
| Leave port is untagged | Tag is removed | Frame remain untagged |

Table 4-5-1: Ingress / Egress Port with VLAN VID Tag / Untag Table

■ IEEE 802.1Q Tunneling (Q-in-Q)

IEEE 802.1Q Tunneling (QinQ) is designed for service providers carrying traffic for multiple customers across their networks. QinQ tunneling is used to maintain customer-specific VLAN and Layer 2 protocol configurations even when different customers use the same internal VLAN IDs. This is accomplished by inserting **Service Provider VLAN (SPVLAN)** tags into the customer's frames when they enter the service provider's network, and then stripping the tags when the frames leave the network.

A service provider's customers may have specific requirements for their internal VLAN IDs and number of VLANs supported. VLAN ranges required by different customers in the same service-provider network might easily overlap, and traffic passing through the infrastructure might be mixed. Assigning a unique range of VLAN IDs to each customer would restrict customer configurations, require intensive processing of VLAN mapping tables, and could easily exceed the maximum VLAN limit of 4096.

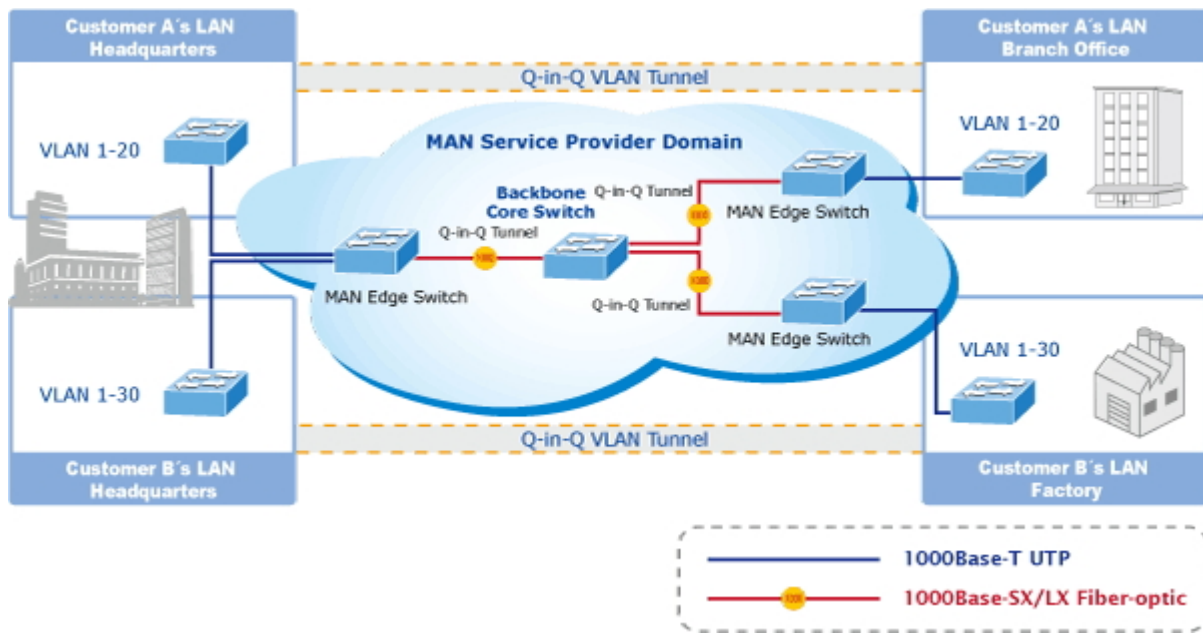

The LRP Managed Switch supports multiple VLAN tags and can therefore be used in MAN applications as a provider bridge, aggregating traffic from numerous independent customer LANs into the **MAN (Metro Access Network)** space. One of the purposes of the provider bridge is to recognize and use VLAN tags so that the VLANs in the MAN space can be used independent of the customers' VLANs. This is accomplished by adding a VLAN tag with a MAN-related VID for frames entering the MAN. When leaving the MAN, the tag is stripped and the original VLAN tag with the customer-related VID is again available.

This provides a tunneling mechanism to connect remote customer VLANs through a common MAN space without interfering with the VLAN tags. All tags use EtherType **0x8100** or **0x88A8**, where 0x8100 is used for customer tags and 0x88A8 are used for service provider tags.

In cases where a given service VLAN only has two member ports on the switch, the learning can be disabled for the particular VLAN and can therefore rely on flooding as the forwarding mechanism between the two ports. This way, the MAC table requirements is reduced.

Edit Interface Setting

The Edit Interface Setting/Status screens in [Figure 4-5-5](#) & [Figure 4-5-6](#) appear.

| Port Select | Interface VLAN Mode | PVID | Accepted Type | Ingress Filtering | Uplink | TPID |
|--------------|---|--------------|--|---|---|--------|
| Select Ports | <input checked="" type="radio"/> Hybrid Tunnel <input type="radio"/> Access <input type="radio"/> Trunk <input type="radio"/> | 1 (1 - 4094) | <input checked="" type="radio"/> All Only <input type="radio"/> Tag Only <input type="radio"/> Untag | <input checked="" type="radio"/> Enabled <input type="radio"/> Disabled | <input type="radio"/> Enabled <input checked="" type="radio"/> Disabled | 0x8100 |

Apply

Figure 4-5-5 Edit Interface Setting Page Screenshot

The page includes the following fields:

| Object | Description |
|--|--|
| <ul style="list-style-type: none"> • Port Select | <p>Select port number from this drop-down list to set VLAN port setting.</p> |
| <ul style="list-style-type: none"> • Interface VLAN Mode | <p>Set the port in access, trunk, hybrid and tunnel mode.</p> <ul style="list-style-type: none"> ■ Trunk means the port allows traffic of multiple VLANs. ■ Access indicates the port belongs to one VLAN only. ■ Hybrid means the port allows the traffic of multi-VLANs to pass in tag or untag mode. ■ Tunnel configures IEEE 802.1Q tunneling for a downlink port to another device within the customer network. |
| <ul style="list-style-type: none"> • PVID | <p>Allows you to assign PVID to selected port.</p> <p>The PVID will be inserted into all untagged frames entering the ingress port. The PVID must be the same as the VLAN ID that the port belongs to VLAN group, or the untagged traffic will be dropped.</p> <p>The range for the PVID is 1-4094.</p> |
| <ul style="list-style-type: none"> • Accepted Type | <p>Determines whether the port accepts all frames or only tagged frames. This parameter affects VLAN ingress processing. If the port only accepts tagged frames, untagged frames received on the port are discarded.</p> <p>Options:</p> <ul style="list-style-type: none"> ■ All ■ Tag Only ■ Untag Only <p>By default, the field is set to All.</p> |
| <ul style="list-style-type: none"> • Ingress Filtering | <ul style="list-style-type: none"> • If ingress filtering is enabled (checkbox is checked), frames classified to a VLAN that the port is not a member of get discarded. • If ingress filtering is disabled, frames classified to a VLAN that the port is not a member of are accepted and forwarded to the switch engine. <p>However, the port will never transmit frames classified to VLANs that it is not a member of.</p> |
| <ul style="list-style-type: none"> • Uplink | <p>Enable/disable uplink function in trunk port.</p> |
| <ul style="list-style-type: none"> • TPID | <p>Configure the type (TPID) of the protocol of switch trunk port.</p> |

Buttons

: Click to apply changes.

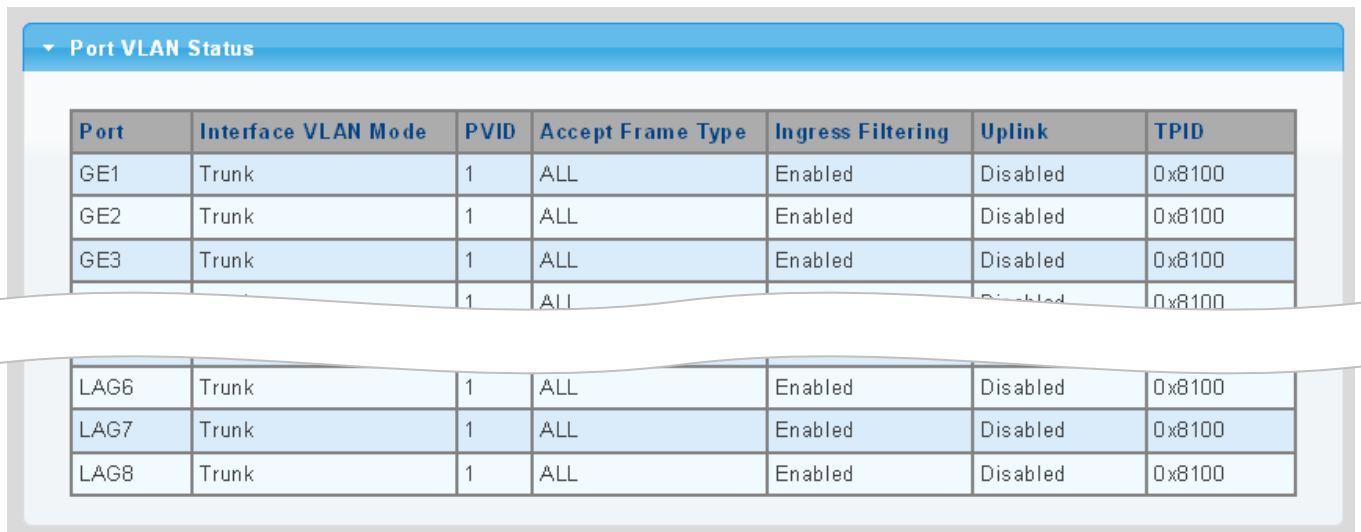

| Port | Interface VLAN Mode | PVID | Accept Frame Type | Ingress Filtering | Uplink | TPID |
|------|---------------------|------|-------------------|-------------------|----------|--------|
| GE1 | Trunk | 1 | ALL | Enabled | Disabled | 0x8100 |
| GE2 | Trunk | 1 | ALL | Enabled | Disabled | 0x8100 |
| GE3 | Trunk | 1 | ALL | Enabled | Disabled | 0x8100 |
| LAG6 | Trunk | 1 | ALL | Enabled | Disabled | 0x8100 |
| LAG7 | Trunk | 1 | ALL | Enabled | Disabled | 0x8100 |
| LAG8 | Trunk | 1 | ALL | Enabled | Disabled | 0x8100 |

Figure 4-5-6 Edit Interface Setting Page Screenshot

The page includes the following fields:

| Object | Description |
|------------------------------|--|
| • Port | The switch port number of the logical port |
| • Interface VLAN Mode | Display the current interface VLAN mode |
| • PVID | Display the current PVID |
| • Accepted Frame Type | Display the current access frame type |
| • Ingress Filtering | Display the current ingress filtering |
| • Uplink | Display the current uplink mode |
| • TPID | Display the current TPID |

4.5.6 Port to VLAN

Use the VLAN Static Table to configure port members for the selected VLAN index. This page allows you to add and delete port members of each VLAN. The screen in [Figure 4-5-7](#) appears.



Figure 4-5-7 Port to VLAN Setting Page Screenshot

The page includes the following fields:

| Object | Description | | | | | | | | |
|------------------------------|--|-------------------|--|------------------|--|----------------|--|------------------|---|
| • VLAN ID | Select VLAN ID from this drop-down list to assign VLAN membership. | | | | | | | | |
| • Port | The switch port number of the logical port. | | | | | | | | |
| • Interface VLAN Mode | Display the current interface VLAN mode. | | | | | | | | |
| • Membership | Select VLAN membership for each interface by marking the appropriate radio button for a port or trunk: <table border="1" data-bbox="523 1601 1418 2033"> <tbody> <tr> <td>Forbidden:</td> <td>Interface is forbidden from automatically joining the VLAN via GVRP.</td> </tr> <tr> <td>Excluded:</td> <td>Interface is not a member of the VLAN. Packets associated with this VLAN will not be transmitted by the interface.</td> </tr> <tr> <td>Tagged:</td> <td>Interface is a member of the VLAN. All packets transmitted by the port will be tagged, that is, carry a tag and therefore carry VLAN or CoS information.</td> </tr> <tr> <td>Untagged:</td> <td>Interface is a member of the VLAN. All packets transmitted by the port will be untagged, that is, not carry a tag and therefore not</td> </tr> </tbody> </table> | Forbidden: | Interface is forbidden from automatically joining the VLAN via GVRP. | Excluded: | Interface is not a member of the VLAN. Packets associated with this VLAN will not be transmitted by the interface. | Tagged: | Interface is a member of the VLAN. All packets transmitted by the port will be tagged, that is, carry a tag and therefore carry VLAN or CoS information. | Untagged: | Interface is a member of the VLAN. All packets transmitted by the port will be untagged, that is, not carry a tag and therefore not |
| Forbidden: | Interface is forbidden from automatically joining the VLAN via GVRP. | | | | | | | | |
| Excluded: | Interface is not a member of the VLAN. Packets associated with this VLAN will not be transmitted by the interface. | | | | | | | | |
| Tagged: | Interface is a member of the VLAN. All packets transmitted by the port will be tagged, that is, carry a tag and therefore carry VLAN or CoS information. | | | | | | | | |
| Untagged: | Interface is a member of the VLAN. All packets transmitted by the port will be untagged, that is, not carry a tag and therefore not | | | | | | | | |

| | |
|--------|---|
| | carry VLAN or CoS information. Note that an interface must be assigned to at least one group as an untagged port. |
| • PVID | Display the current PVID |

Buttons

 : Click to apply changes.

4.5.7 Port VLAN Membership

This page provides an overview of membership status for VLAN users. The VLAN Membership Status screen in [Figure 4-5-8](#) appears.

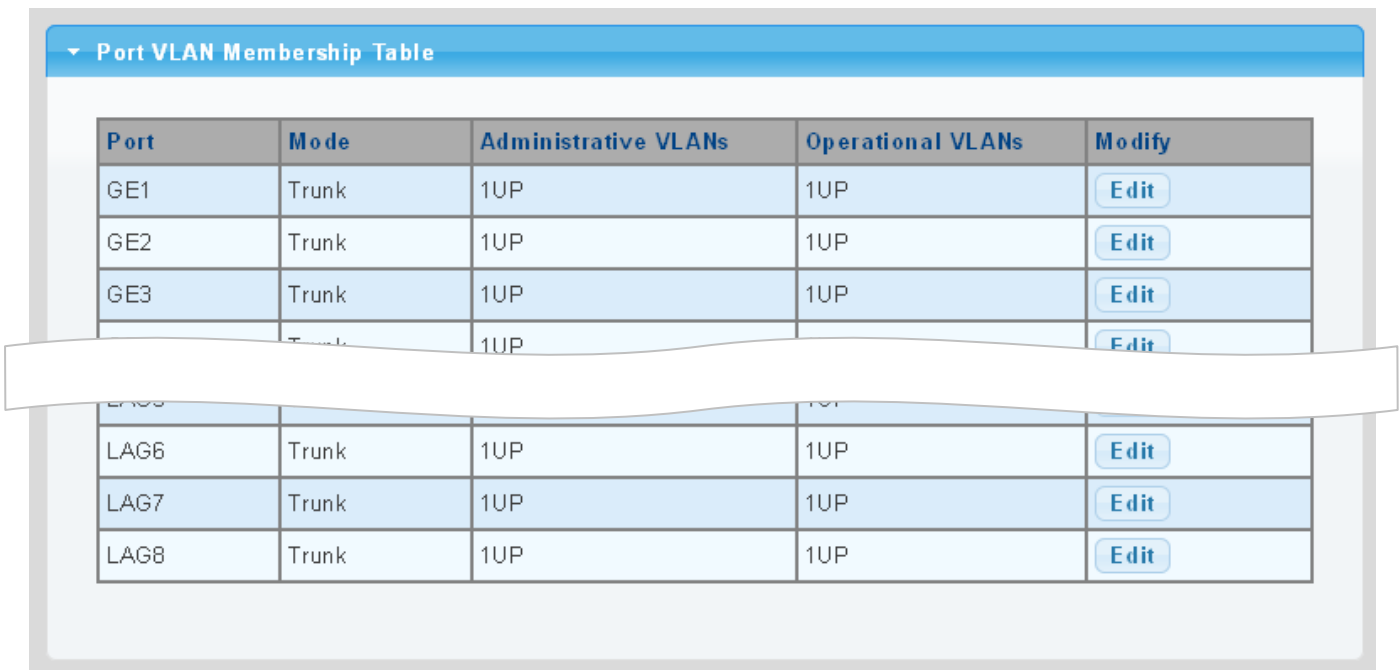

| Port | Mode | Administrative VLANs | Operational VLANs | Modify |
|------|-------|----------------------|-------------------|----------------------|
| GE1 | Trunk | 1UP | 1UP | Edit |
| GE2 | Trunk | 1UP | 1UP | Edit |
| GE3 | Trunk | 1UP | 1UP | Edit |
| LAG6 | Trunk | 1UP | 1UP | Edit |
| LAG7 | Trunk | 1UP | 1UP | Edit |
| LAG8 | Trunk | 1UP | 1UP | Edit |

Figure 4-5-8 Port VLAN Membership Table Page Screenshot

The page includes the following fields:

| Object | Description |
|------------------------|--|
| • Port | The switch port number of the logical port |
| • Mode | Display the current VLAN mode |
| • Administrative VLANs | Display the current administrative VLANs |
| • Operational VLANs | Display the current operational VLANs |
| • Modify | Click Edit to modify VLAN membership |

4.5.8 Protocol VLAN Group Setting

The network devices required to support multiple protocols cannot be easily grouped into a common VLAN. This may require non-standard devices to pass traffic between different VLANs in order to encompass all the devices participating in a specific protocol. This kind of configuration deprives users of the basic benefits of VLANs, including security and easy accessibility.

To avoid these problems, you can configure this LRP Managed Switch with protocol-based VLANs that divide the physical network into logical VLAN groups for each required protocol. When a frame is received at a port, its VLAN membership can then be determined based on the protocol type being used by the inbound packets.

Command Usage

To configure protocol-based VLANs, follow these steps:

1. First configure **VLAN groups for the protocols** you want to use. Although not mandatory, we suggest configuring a separate VLAN for each major protocol running on your network. Do not add port members at this time.
2. Create a **protocol group** for each of the protocols you want to assign to a VLAN using the Protocol VLAN Configuration page.
3. Then map the protocol for each interface to the appropriate VLAN using the Protocol VLAN Port Configuration page.

This page allows you to configure protocol-based VLAN Group Setting. The protocol-based VLAN screens in [Figure 4-5-9](#) & [Figure 4-5-10](#) appear.

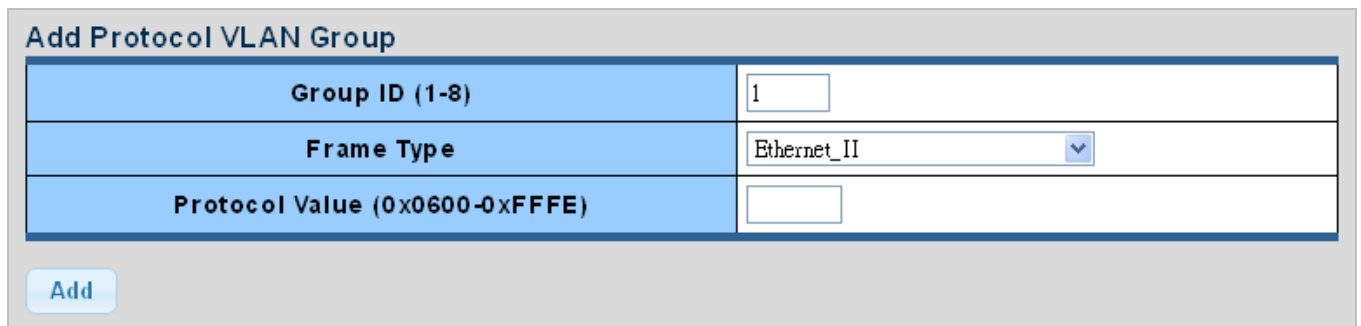

| Add Protocol VLAN Group | |
|---------------------------------|--|
| Group ID (1-8) | <input type="text" value="1"/> |
| Frame Type | <input type="text" value="Ethernet_II"/> |
| Protocol Value (0x0600-0xFFFFE) | <input type="text"/> |

Figure 4-5-9 Add Protocol VLAN Group Page Screenshot

The page includes the following fields:

| Object | Description |
|-------------------------|--|
| • Group ID | Protocol Group ID assigned to the Special Protocol VLAN Group. |
| • Frame Type | <p>Frame Type can have one of the following values:</p> <ul style="list-style-type: none"> ■ Ethernet II ■ IEEE802.3_LL_C_Other ■ RFC_1042 <p>Note: On changing the Frame type field, valid value of the following text field will vary depending on the new frame type you selected.</p> |
| • Protocol Value | Valid value that can be entered in this text field depends on the option selected |

| | |
|------------------------|--|
| (0x0600-0xFFFE) | from the preceding Frame Type selection menu. Valid values for frame type ranges from 0x0600-0xfffe |
|------------------------|--|

Buttons

: Click to apply changes.

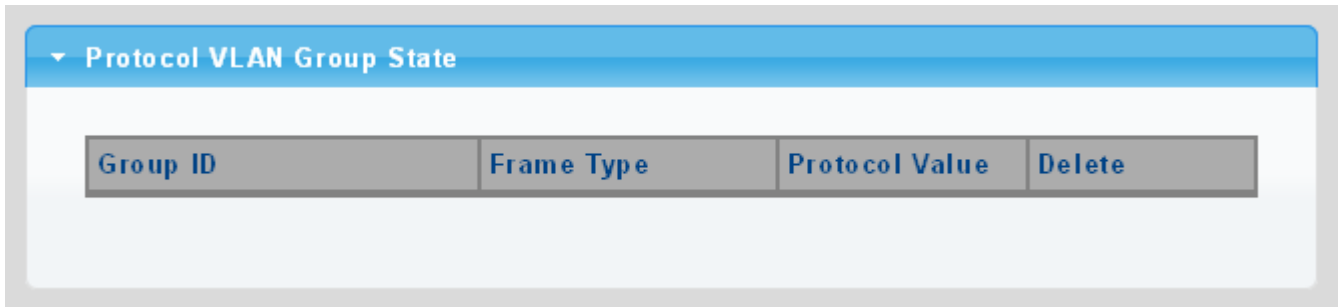



Figure 4-5-10 Protocol VLAN Group State Page Screenshot

The page includes the following fields:

| Object | Description |
|-------------------------|--|
| • Group ID | Display the current group ID |
| • Frame Type | Display the current frame type |
| • Protocol Value | Display the current protocol value |
| • Delete | Click  to delete the group ID entry |

4.5.9 Protocol VLAN Port Setting

This page allows you to map an already configured Group Name to a VLAN/port for the switch. The Protocol VLAN Port Setting/State screens in [Figure 4-5-11](#) & [Figure 4-5-12](#) appear.

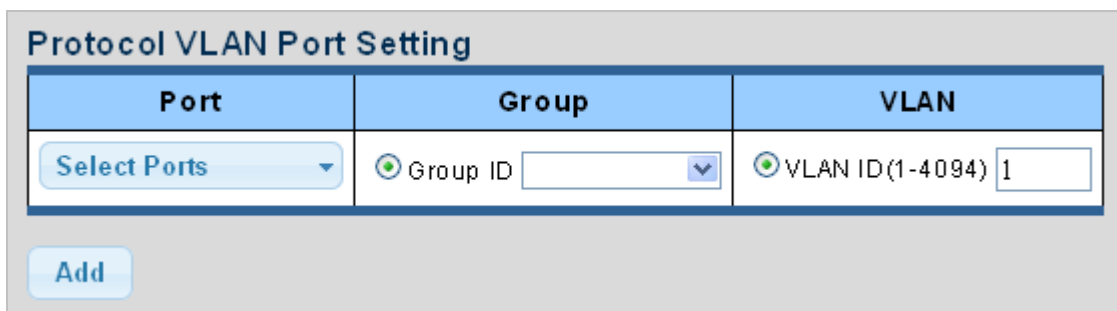



Figure 4-5-11 Protocol VLAN Port Setting Page Screenshot

The page includes the following fields:

| Object | Description |
|---------|---|
| • Port | Select port from this drop-down list to assign protocol VLAN port |
| • Group | Select group ID from this drop-down list to protocol VLAN group |
| • VLAN | VLAN ID assigned to the Special Protocol VLAN Group |

Buttons

: Click to add protocol VLAN port entry.

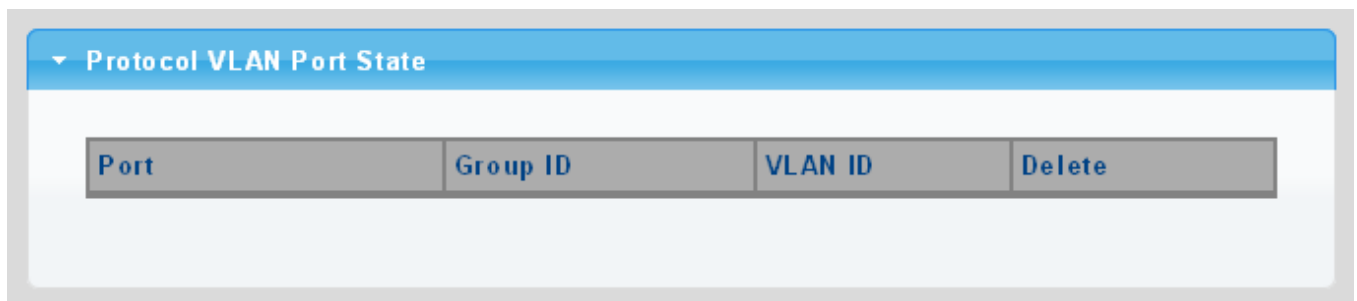



Figure 4-5-12 Protocol VLAN Port State Page Screenshot

The page includes the following fields:

| Object | Description |
|------------|--|
| • Port | Display the current port |
| • Group ID | Display the current group ID |
| • VLAN ID | Display the current VLAN ID |
| • Delete | Click  to delete the group ID entry |

4.5.10 GVRP Setting

GARP VLAN Registration Protocol (GVRP) defines a way for switches to exchange VLAN information in order to register VLAN members on ports across the network.

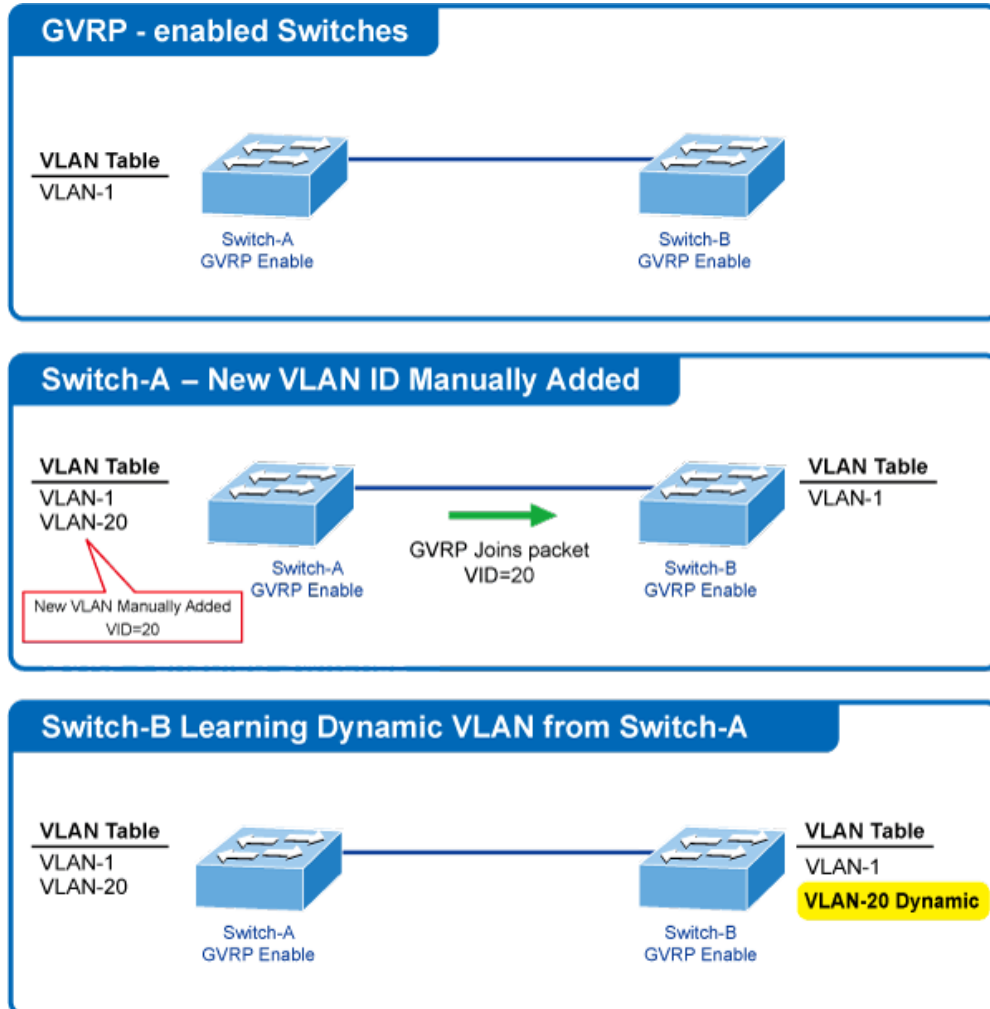

VLANs are **dynamically** configured based on **join messages** issued by host devices and propagated throughout the network. GVRP must be enabled to permit automatic VLAN registration, and to support VLANs which extend beyond the local switch.

The GVRP Global Setting/Information screens in [Figure 4-5-13](#) & [Figure 4-5-14](#) appear.

GVRP Global Setting

| | |
|-------------------------|---|
| GVRP | <input checked="" type="radio"/> Disable <input type="radio"/> Enable |
| Join Timeout | 20 (20-16375 centiseconds) |
| Leave Timeout | 60 (45-32760 centiseconds) |
| LeaveAll Timeout | 1000 (65-32765 centiseconds) |

Apply

Figure 4-5-13 GVRP Global Setting Page Screenshot

The page includes the following fields:

| Object | Description |
|---------------------------|---|
| • GVRP | Controls whether GVRP is enabled or disabled on this switch. |
| • Join Timeout | The interval between transmitting requests/queries to participate in a VLAN group. Range: 20-16375 centiseconds Default: 20 centiseconds |
| • Leave Timeout | The interval a port waits before leaving a VLAN group. This time should be set to more than twice the join time. This ensures that after a Leave or LeaveAll message has been issued, the applicants can rejoin before the port actually leaves the group. Range: 45-32760 centiseconds Default: 60 centiseconds |
| • LeaveAll Timeout | The interval between sending out a LeaveAll query message for VLAN group participants and the port leaving the group. This interval should be considerably larger than the Leave Time to minimize the amount of traffic generated by nodes rejoining the group. Range: 65-32765 centiseconds; Default: 1000 centiseconds |



Timer settings must follow this rule:

$$2 \times (\text{join timer}) < \text{leave timer} < \text{leaveAll timer}$$

Buttons



: Click to apply changes.

| GVRP Informations | |
|-------------------|-------------------|
| Information Name | Information Value |
| GVRP Status | Disabled |
| Join Timeout | 200 millisecond |
| Leave Timeout | 600 millisecond |
| LeaveAll Timeout | 10000 millisecond |

Figure 4-5-14 GVRP Global Setting Page Screenshot

The page includes the following fields:

| Object | Description |
|---------------------------|--|
| • GVRP Status | Display the current GVRP status |
| • Join Timeout | Display the current join timeout parameter |
| • Leave Timeout | Display the current leave timeout parameter |
| • LeaveAll Timeout | Display the current leaveall timeout parameter |

4.5.11 GVRP Port Setting

The GVRP Port Setting/Status screens in [Figure 4-5-15](#) & [Figure 4-5-16](#) appear.

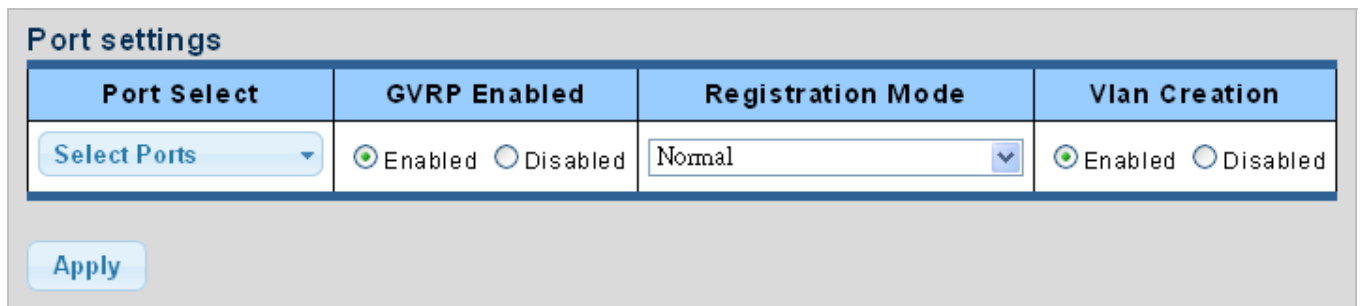



Figure 4-5-15 GVRP Global Setting Page Screenshot

The page includes the following fields:

| Object | Description |
|----------------------------|---|
| • Port Select | Select port from this drop-down list to assign protocol VLAN port |
| • GVRP Enabled | Controls whether GVRP is enabled or disabled on port |
| • Registration Mode | By default GVRP ports are in normal registration mode. These ports use GVRP join messages from neighboring switches to prune the VLANs running across the 802.1Q trunk link. If the device on the other side is not capable of sending GVRP messages, or if you do not want to allow the switch to prune any of the VLANs, use the fixed mode. Fixed mode ports will forward for all VLANs that exist in the switch database. Ports in forbidden mode forward only for VLAN 1. |
| • VLAN Creation | GVRP can dynamically create VLANs on switches for trunking purposes. By enabling GVRP dynamic VLAN creation, a switch will add VLANs to its database when it receives GVRP join messages about VLANs it does not have. |

Buttons

: Click to apply changes.

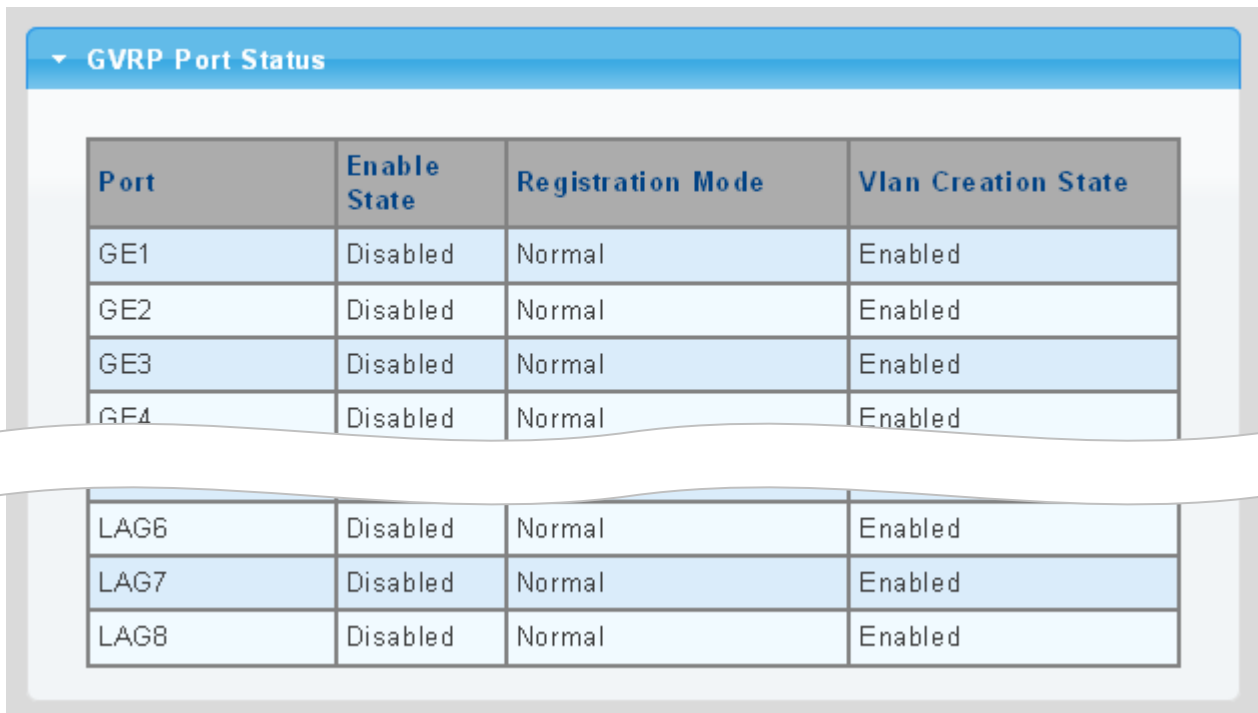

| GVRP Port Status | | | |
|------------------|--------------|-------------------|---------------------|
| Port | Enable State | Registration Mode | Vlan Creation State |
| GE1 | Disabled | Normal | Enabled |
| GE2 | Disabled | Normal | Enabled |
| GE3 | Disabled | Normal | Enabled |
| GE4 | Disabled | Normal | Enabled |
| LAG6 | Disabled | Normal | Enabled |
| LAG7 | Disabled | Normal | Enabled |
| LAG8 | Disabled | Normal | Enabled |

Figure 4-5-16 GVRP Port Status Page Screenshot

The page includes the following fields:

| Object | Description |
|-------------------------------|--|
| • Port | The switch port number of the logical port |
| • Enable Status | Display the current GVRP port state |
| • Registration Mode | Display the current registration mode |
| • VLAN Creation Status | Display the current VLAN creation status |

4.5.12 GVRP VLAN

The GVRP VLAN Database screen in [Figure 4-5-17](#) appears.

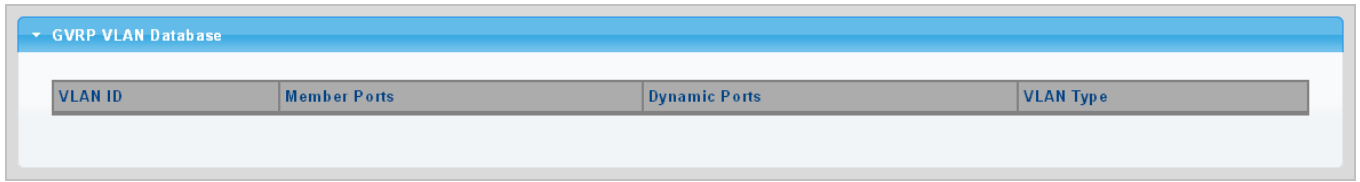

Figure 4-5-17 GVRP VLAN Database Status Page Screenshot

The page includes the following fields:

| Object | Description |
|-----------------|-----------------------------------|
| • VLAN ID | Display the current VLAN ID |
| • Member Ports | Display the current member ports |
| • Dynamic Ports | Display the current dynamic ports |
| • VLAN Type | Display the current VLAN type |

4.5.13 GVRP Statistics

The GVRP Port Statistics and Error Statistics screens in [Figure 4-5-18](#) & [Figure 4-5-19](#) appear.

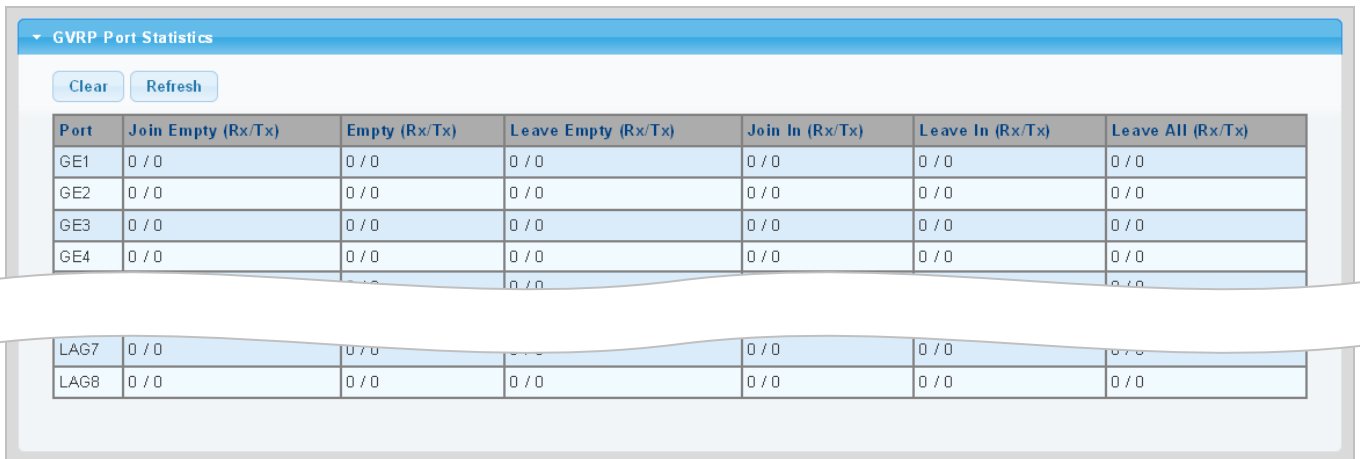
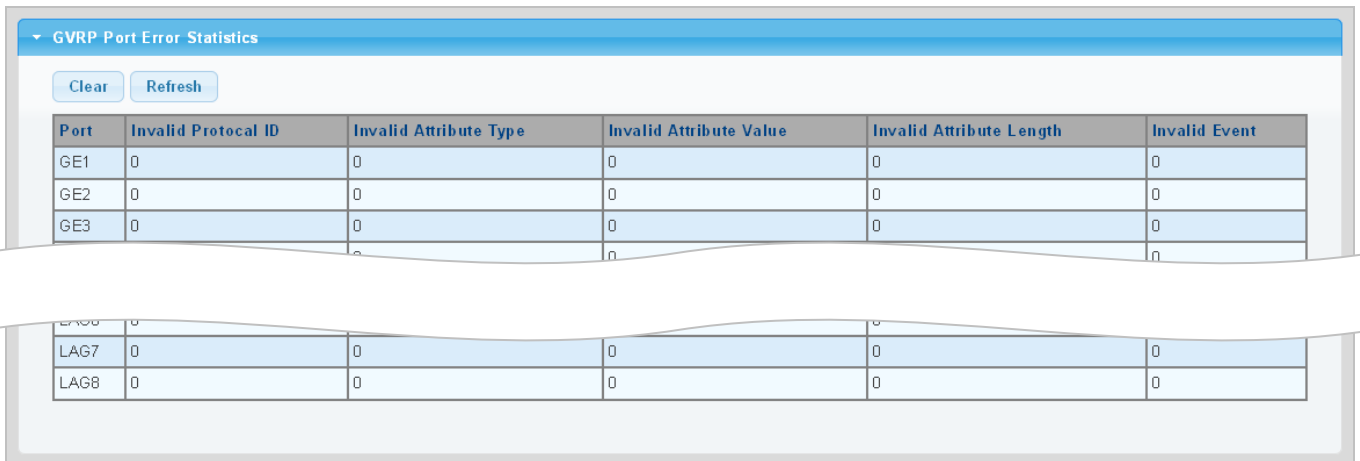

Figure 4-5-18 GVRP Port Statistics Page Screenshot

The page includes the following fields:

| Object | Description |
|----------------------|--|
| • Port | The switch port number of the logical port |
| • Join Empty (Rx/Tx) | Display the current join empty (TX/RX) packets |

| | |
|-----------------------|---|
| • Empty (Rx/Tx) | Display the current empty (TX/RX) packets |
| • Leave Empty (Rx/Tx) | Display the current leave empty (TX/RX) packets |
| • Join In (Rx/Tx) | Display the current join in (TX/RX) packets |
| • Leave In (Rx/Tx) | Display the current leave in (TX/RX) packets |
| • LeaveAll (Rx/Tx) | Display the current leaveall (TX/RX) packets |



| Port | Invalid Protocol ID | Invalid Attribute Type | Invalid Attribute Value | Invalid Attribute Length | Invalid Event |
|------|---------------------|------------------------|-------------------------|--------------------------|---------------|
| GE1 | 0 | 0 | 0 | 0 | 0 |
| GE2 | 0 | 0 | 0 | 0 | 0 |
| GE3 | 0 | 0 | 0 | 0 | 0 |
| LAG7 | 0 | 0 | 0 | 0 | 0 |
| LAG8 | 0 | 0 | 0 | 0 | 0 |

Figure 4-5-19 GVRP Port Error Statistics Page Screenshot

The page includes the following fields:

| Object | Description |
|----------------------------|--|
| • Port | The switch port number of the logical port. |
| • Invalid Protocol ID | Display the current invalid protocol ID |
| • Invalid Attribute Type | Display the current invalid attribute type |
| • Invalid Attribute Value | Display the current invalid attribute value |
| • Invalid Attribute Length | Display the current invalid attribute length |
| • Invalid Event | Display the current invalid event. |

Buttons

Clear : Click to clear the GVRP Error Statistics.

Refresh : Click to refresh the GVRP Error Statistics.

4.5.14 VLAN setting example:

- Separate VLANs
- 802.1Q VLAN Trunk

4.5.14.1 Two Separate 802.1Q VLANs

The diagram shows how the LRP Managed Switch handles Tagged and Untagged traffic flow for two VLANs. VLAN Group 2 and VLAN Group 3 are separated VLANs. Each VLAN isolates network traffic so only members of the VLAN receive traffic from the same VLAN members. The screen in [Figure 4-5-20](#) appears and [Table 4-5-2](#) describes the port configuration of the LRP Managed Switches.

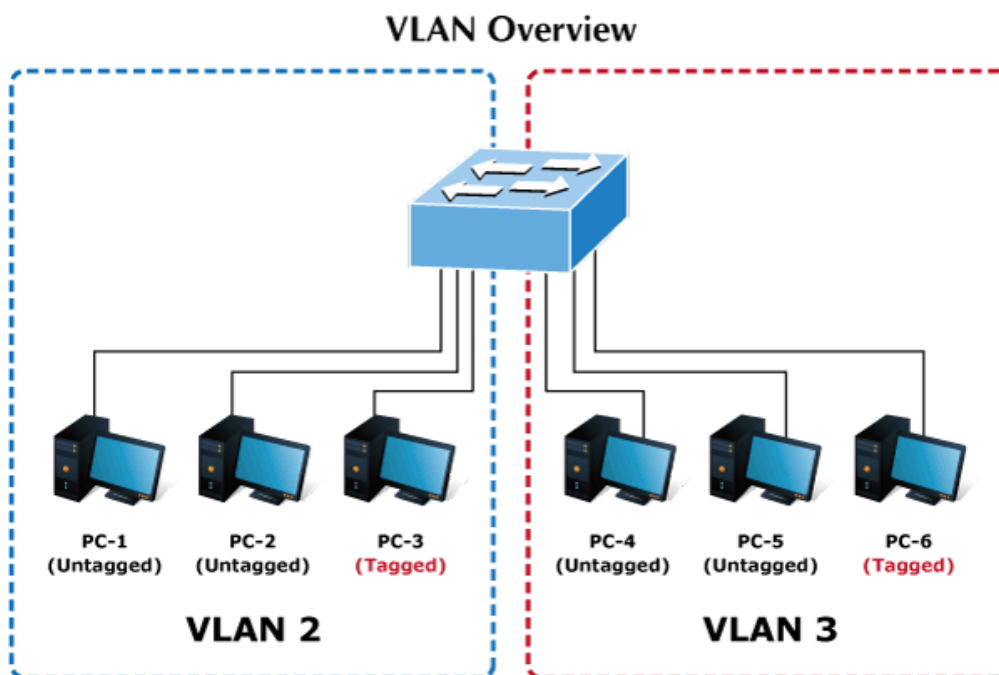

Figure 4-5-20 Two Separate VLAN Diagrams

| VLAN Group | VID | Untagged Members | Tagged Members |
|--------------|-----|------------------|----------------|
| VLAN Group 1 | 1 | Port-7~Port-8 | N/A |
| VLAN Group 2 | 2 | Port-1,Port-2 | Port-3 |
| VLAN Group 3 | 3 | Port-4,Port-5 | Port-6 |

Table 4-5-2 VLAN and Port Configuration

The scenario described as follows:

■ **Untagged packet entering VLAN 2**

1. While [PC-1] transmits an **untagged** packet enters **Port-1**, the LRP Managed Switch will tag it with a **VLAN Tag=2**. [PC-2] and [PC-3] will receive the packet through **Port-2** and **Port-3**.

2. [PC-4],[PC-5] and [PC-6] receive no packet.
3. While the packet leaves **Port-2**, it will be stripped away its tag becoming an **untagged** packet.
4. While the packet leaves **Port-3**, it will be kept as a **tagged** packet with **VLAN Tag=2**.

■ Tagged packet entering VLAN 2

1. While [PC-3] transmits a **tagged** packet with **VLAN Tag=2** entering **Port-3**. [PC-1] and [PC-2] will receive the packet through **Port-1** and **Port-2**.
2. While the packet leaves **Port-1** and **Port-2**, it will be stripped away its tag becoming an **untagged** packet.

■ Untagged packet entering VLAN 3

1. While [PC-4] transmits an **untagged** packet enters **Port-4**, the switch will tag it with a **VLAN Tag=3**. [PC-5] and [PC-6] will receive the packet through **Port-5** and **Port-6**.
2. While the packet leaves **Port-5**, it will be stripped away its tag becoming an **untagged** packet.
3. While the packet leaves **Port-6**, it will be kept as a **tagged** packet with **VLAN Tag=3**.



In this example, VLAN Group 1 is set as default VLAN, but only focuses on VLAN 2 and VLAN 3 traffic flow.

Setup Steps

1. Create VLAN Group 2 and 3

Add VLAN group 2 and group 3

| VLAN Table | | |
|------------|-----------|-----------|
| VLAN ID | VLAN Name | VLAN Type |
| 1 | default | Default |
| 2 | 20002 | Static |
| 3 | 30003 | Static |

2. Assign VLAN mode and PVID to each port:

Port-1,Port-2 and Port-3 : VLAN Mode = Hybrid, PVID=2

Port-4,Port-5 and Port-6 : VLAN Mode = Hybrid, PVID=3

| Port VLAN Status | | | |
|------------------|---------------------|------|-------------------|
| Port | Interface VLAN Mode | PVID | Accept Frame Type |
| GE1 | Hybrid | 2 | ALL |
| GE2 | Hybrid | 2 | ALL |
| GE3 | Hybrid | 2 | ALL |
| GE4 | Hybrid | 3 | ALL |
| GE5 | Hybrid | 3 | ALL |
| GE6 | Hybrid | 3 | ALL |

3. Assign Tagged/Untagged to each port:

VLAN ID = 2:

Port-1 & 2 = Untagged,

Port-3 = Tagged,

Port -4~6 = Excluded.

| Port to VLAN Settings | | | |
|-----------------------|---------------------|---|-------------------------------------|
| VLAN ID : 2 | | | |
| Port | Interface VLAN Mode | Membership | PVID |
| GE1 | Hybrid | <input type="radio"/> Forbidden <input type="radio"/> Excluded <input type="radio"/> Tagged <input checked="" type="radio"/> Untagged | <input checked="" type="checkbox"/> |
| GE2 | Hybrid | <input type="radio"/> Forbidden <input type="radio"/> Excluded <input type="radio"/> Tagged <input checked="" type="radio"/> Untagged | <input checked="" type="checkbox"/> |
| GE3 | Hybrid | <input type="radio"/> Forbidden <input type="radio"/> Excluded <input checked="" type="radio"/> Tagged <input type="radio"/> Untagged | <input checked="" type="checkbox"/> |
| GE4 | Hybrid | <input type="radio"/> Forbidden <input checked="" type="radio"/> Excluded <input type="radio"/> Tagged <input type="radio"/> Untagged | <input type="checkbox"/> |
| GE5 | Hybrid | <input type="radio"/> Forbidden <input checked="" type="radio"/> Excluded <input type="radio"/> Tagged <input type="radio"/> Untagged | <input type="checkbox"/> |
| GE6 | Hybrid | <input type="radio"/> Forbidden <input checked="" type="radio"/> Excluded <input type="radio"/> Tagged <input type="radio"/> Untagged | <input type="checkbox"/> |

VLAN ID = 3:

Port-4 & 5 = Untagged,

Port -6 = Tagged,

Port-1~3 = Excluded.

| Port to VLAN Settings | | | |
|-----------------------|---------------------|---|-------------------------------------|
| VLAN ID : 3 | | | |
| Port | Interface VLAN Mode | Membership | PVID |
| GE1 | Hybrid | <input type="radio"/> Forbidden <input checked="" type="radio"/> Excluded <input type="radio"/> Tagged <input type="radio"/> Untagged | <input type="checkbox"/> |
| GE2 | Hybrid | <input type="radio"/> Forbidden <input checked="" type="radio"/> Excluded <input type="radio"/> Tagged <input type="radio"/> Untagged | <input type="checkbox"/> |
| GE3 | Hybrid | <input type="radio"/> Forbidden <input checked="" type="radio"/> Excluded <input type="radio"/> Tagged <input type="radio"/> Untagged | <input type="checkbox"/> |
| GE4 | Hybrid | <input type="radio"/> Forbidden <input type="radio"/> Excluded <input type="radio"/> Tagged <input checked="" type="radio"/> Untagged | <input checked="" type="checkbox"/> |
| GE5 | Hybrid | <input type="radio"/> Forbidden <input type="radio"/> Excluded <input type="radio"/> Tagged <input checked="" type="radio"/> Untagged | <input checked="" type="checkbox"/> |
| GE6 | Hybrid | <input type="radio"/> Forbidden <input type="radio"/> Excluded <input checked="" type="radio"/> Tagged <input type="radio"/> Untagged | <input checked="" type="checkbox"/> |

4.5.14.2 VLAN Trunking between Two 802.1Q Aware Switches

In most cases, they are used for “Uplink” to other switches. VLANs are separated at different switches, but they need to access other switches within the same VLAN group. The screen in [Figure 4-5-21](#) appears.

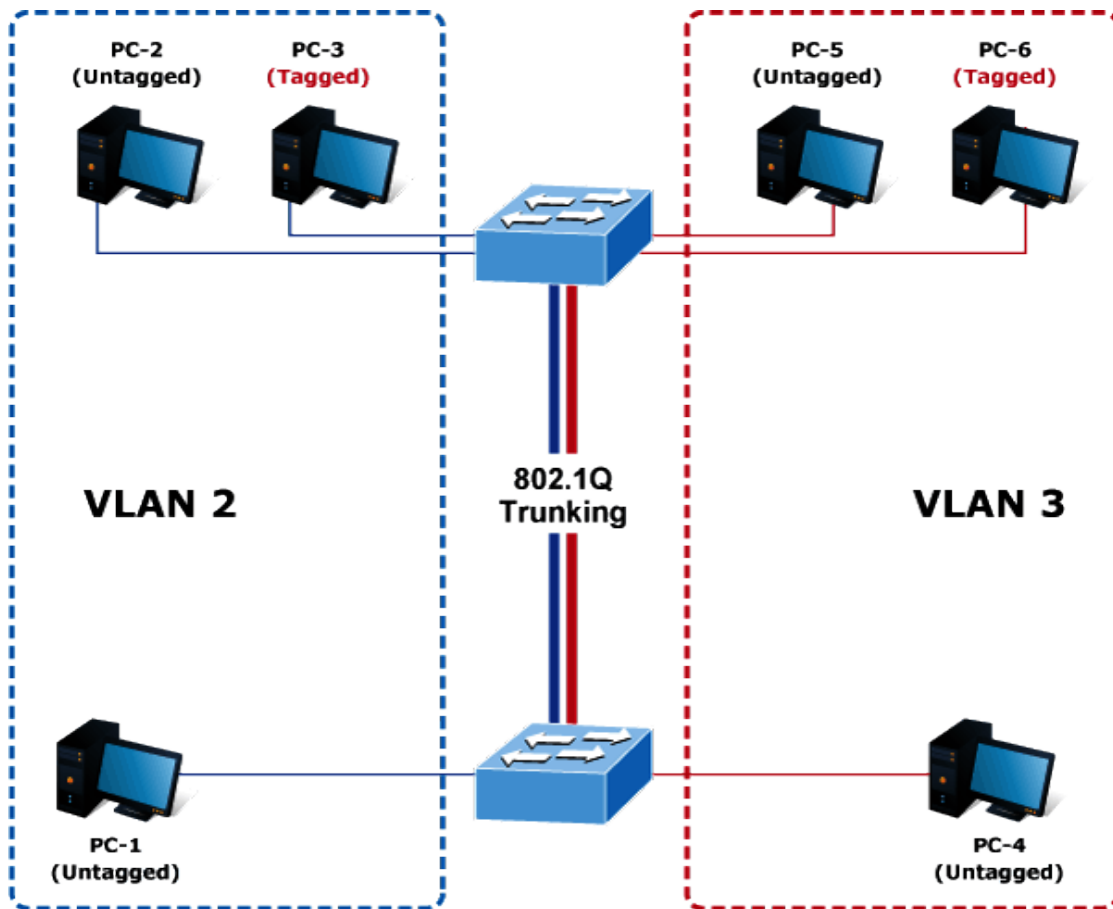

Setup steps

1. Create VLAN Group 2 and 3

Add VLAN group 2 and group 3

| VLAN Table | | |
|------------|-----------|-----------|
| VLAN ID | VLAN Name | VLAN Type |
| 1 | default | Default |
| 2 | 20002 | Static |
| 3 | 30003 | Static |

2. Assign VLAN mode and PVID to each port:

Port-1,Port-2 and Port-3 : VLAN Mode = Hybrid, PVID=2

Port-4,Port-5 and Port-6 : VLAN Mode = Hybrid, PVID=3

Port-7 : VLAN Mode = Hybrid, PVID=1

| Port VLAN Status | | | |
|------------------|---------------------|------|-------------------|
| Port | Interface VLAN Mode | PVID | Accept Frame Type |
| GE1 | Hybrid | 2 | ALL |
| GE2 | Hybrid | 2 | ALL |
| GE3 | Hybrid | 2 | ALL |
| GE4 | Hybrid | 3 | ALL |
| GE5 | Hybrid | 3 | ALL |
| GE6 | Hybrid | 3 | ALL |
| GE7 | Hybrid | 1 | ALL |

3. Assign Tagged/Untagged to each port:

VLAN ID = 1:

Port-1~6 = Untagged,

Port -7 = Excluded.

| Port to VLAN Settings | | | |
|-----------------------|---------------------|---|-------------------------------------|
| VLAN ID : 1 | | | |
| Port | Interface VLAN Mode | Membership | PVID |
| GE1 | Hybrid | <input type="radio"/> Forbidden <input type="radio"/> Excluded <input type="radio"/> Tagged <input checked="" type="radio"/> Untagged | <input type="checkbox"/> |
| GE2 | Hybrid | <input type="radio"/> Forbidden <input type="radio"/> Excluded <input type="radio"/> Tagged <input checked="" type="radio"/> Untagged | <input type="checkbox"/> |
| GE3 | Hybrid | <input type="radio"/> Forbidden <input type="radio"/> Excluded <input type="radio"/> Tagged <input checked="" type="radio"/> Untagged | <input type="checkbox"/> |
| GE4 | Hybrid | <input type="radio"/> Forbidden <input type="radio"/> Excluded <input type="radio"/> Tagged <input checked="" type="radio"/> Untagged | <input type="checkbox"/> |
| GE5 | Hybrid | <input type="radio"/> Forbidden <input type="radio"/> Excluded <input type="radio"/> Tagged <input checked="" type="radio"/> Untagged | <input type="checkbox"/> |
| GE6 | Hybrid | <input type="radio"/> Forbidden <input type="radio"/> Excluded <input type="radio"/> Tagged <input checked="" type="radio"/> Untagged | <input type="checkbox"/> |
| GE7 | Hybrid | <input type="radio"/> Forbidden <input type="radio"/> Excluded <input checked="" type="radio"/> Tagged <input type="radio"/> Untagged | <input checked="" type="checkbox"/> |

VLAN ID = 2:

Port-1 & 2 = Untagged,

Port-3 & 7 = Tagged,

Port -4~6 = Excluded.

Port to VLAN Settings

VLAN ID : 2

| Port | Interface VLAN Mode | Membership | PVID |
|------|---------------------|---|-------------------------------------|
| GE1 | Hybrid | <input type="radio"/> Forbidden <input type="radio"/> Excluded <input type="radio"/> Tagged <input checked="" type="radio"/> Untagged | <input checked="" type="checkbox"/> |
| GE2 | Hybrid | <input type="radio"/> Forbidden <input type="radio"/> Excluded <input type="radio"/> Tagged <input checked="" type="radio"/> Untagged | <input checked="" type="checkbox"/> |
| GE3 | Hybrid | <input type="radio"/> Forbidden <input type="radio"/> Excluded <input checked="" type="radio"/> Tagged <input type="radio"/> Untagged | <input checked="" type="checkbox"/> |
| GE4 | Hybrid | <input type="radio"/> Forbidden <input checked="" type="radio"/> Excluded <input type="radio"/> Tagged <input type="radio"/> Untagged | <input type="checkbox"/> |
| GE5 | Hybrid | <input type="radio"/> Forbidden <input checked="" type="radio"/> Excluded <input type="radio"/> Tagged <input type="radio"/> Untagged | <input type="checkbox"/> |
| GE6 | Hybrid | <input type="radio"/> Forbidden <input checked="" type="radio"/> Excluded <input type="radio"/> Tagged <input type="radio"/> Untagged | <input type="checkbox"/> |
| GE7 | Hybrid | <input type="radio"/> Forbidden <input type="radio"/> Excluded <input checked="" type="radio"/> Tagged <input type="radio"/> Untagged | <input type="checkbox"/> |

VLAN ID = 3:

Port-4 & 5 = Untagged,

Port -6 & 7= Tagged,

Port-1~3 = Excluded.

Port to VLAN Settings

VLAN ID : 3

| Port | Interface VLAN Mode | Membership | PVID |
|------|---------------------|---|-------------------------------------|
| GE1 | Hybrid | <input type="radio"/> Forbidden <input checked="" type="radio"/> Excluded <input type="radio"/> Tagged <input type="radio"/> Untagged | <input type="checkbox"/> |
| GE2 | Hybrid | <input type="radio"/> Forbidden <input checked="" type="radio"/> Excluded <input type="radio"/> Tagged <input type="radio"/> Untagged | <input type="checkbox"/> |
| GE3 | Hybrid | <input type="radio"/> Forbidden <input checked="" type="radio"/> Excluded <input type="radio"/> Tagged <input type="radio"/> Untagged | <input type="checkbox"/> |
| GE4 | Hybrid | <input type="radio"/> Forbidden <input type="radio"/> Excluded <input type="radio"/> Tagged <input checked="" type="radio"/> Untagged | <input checked="" type="checkbox"/> |
| GE5 | Hybrid | <input type="radio"/> Forbidden <input type="radio"/> Excluded <input type="radio"/> Tagged <input checked="" type="radio"/> Untagged | <input checked="" type="checkbox"/> |
| GE6 | Hybrid | <input type="radio"/> Forbidden <input type="radio"/> Excluded <input checked="" type="radio"/> Tagged <input type="radio"/> Untagged | <input checked="" type="checkbox"/> |
| GE7 | Hybrid | <input type="radio"/> Forbidden <input type="radio"/> Excluded <input checked="" type="radio"/> Tagged <input type="radio"/> Untagged | <input type="checkbox"/> |

4.6 Spanning Tree Protocol

4.6.1 Theory

The Spanning Tree Protocol can be used to detect and disable network loops, and to provide backup links between switches, bridges or routers. This allows the switch to interact with other bridging devices in your network to ensure that only one route exists between any two stations on the network, and provide backup links which automatically take over when a primary link goes down. The spanning tree algorithms supported by this switch include these versions:

- **STP – Spanning Tree Protocol (IEEE 802.1D)**
- **RSTP – Rapid Spanning Tree Protocol (IEEE 802.1w)**
- **MSTP – Multiple Spanning Tree Protocol (IEEE 802.1s)**

The **IEEE 802.1D Spanning Tree Protocol** and **IEEE 802.1w Rapid Spanning Tree Protocol** allow for the blocking of links between switches that form loops within the network. When multiple links between switches are detected, a primary link is established. Duplicated links are blocked from use and become standby links. The protocol allows for the duplicate links to be used in the event of a failure of the primary link. Once the Spanning Tree Protocol is configured and enabled, primary links are established and duplicated links are blocked automatically. The reactivation of the blocked links (at the time of a primary link failure) is also accomplished automatically without operator intervention.

This automatic network reconfiguration provides maximum uptime to network users. However, the concepts of the Spanning Tree Algorithm and protocol are a complicated and complex subject and must be fully researched and understood. It is possible to cause serious degradation of the performance of the network if the Spanning Tree is incorrectly configured. Please read the following before making any changes from the default values.

The Switch STP performs the following functions:

- Creates a single spanning tree from any combination of switching or bridging elements.
- Creates multiple spanning trees – from any combination of ports contained within a single switch, in user specified groups.
- Automatically reconfigures the spanning tree to compensate for the failure, addition, or removal of any element in the tree.
- Reconfigures the spanning tree without operator intervention.

Bridge Protocol Data Units

For STP to arrive at a stable network topology, the following information is used:

- The unique switch identifier
- The path cost to the root associated with each switch port
- The port identifier

STP communicates between switches on the network using Bridge Protocol Data Units (BPDUs). Each BPDU contains the following information:

- The unique identifier of the switch that the transmitting switch currently believes is the root switch

- The path cost to the root from the transmitting port
- The port identifier of the transmitting port

The switch sends BPDUs to communicate and construct the spanning-tree topology. All switches connected to the LAN on which the packet is transmitted will receive the BPDU. BPDUs are not directly forwarded by the switch, but the receiving switch uses the information in the frame to calculate a BPDU, and, if the topology changes, initiates a BPDU transmission.

The communication between switches via BPDUs results in the following:

- One switch is elected as the root switch
- The shortest distance to the root switch is calculated for each switch
- A designated switch is selected. This is the switch closest to the root switch through which packets will be forwarded to the root.
- A port for each switch is selected. This is the port providing the best path from the switch to the root switch.
- Ports included in the STP are selected.

Creating a Stable STP Topology

It is to make the root port a fastest link. If all switches have STP enabled with default settings, the switch with the lowest MAC address in the network will become the root switch. By increasing the priority (lowering the priority number) of the best switch, STP can be forced to select the best switch as the root switch.

When STP is enabled using the default parameters, the path between source and destination stations in a switched network might not be ideal. For instance, connecting higher-speed links to a port that has a higher number than the current root port can cause a root-port change.

STP Port States

The BPDUs take some time to pass through a network. This propagation delay can result in topology changes where a port that transitioned directly from a Blocking state to a Forwarding state could create temporary data loops. Ports must wait for new network topology information to propagate throughout the network before starting to forward packets. They must also wait for the packet lifetime to expire for BPDU packets that were forwarded based on the old topology. The forward delay timer is used to allow the network topology to stabilize after a topology change. In addition, STP specifies a series of states a port must transition through to further ensure that a stable network topology is created after a topology change.

Each port on a switch using STP exists in one of the following five states:

- **Blocking** – the port is blocked from forwarding or receiving packets
- **Listening** – the port is waiting to receive BPDU packets that may tell the port to go back to the blocking state
- **Learning** – the port is adding addresses to its forwarding database, but not yet forwarding packets
- **Forwarding** – the port is forwarding packets
- **Disabled** – the port only responds to network management messages and must return to the blocking state first

A port transitions from one state to another as follows:

- From initialization (switch boot) to blocking
- From blocking to listening or to disabled
- From listening to learning or to disabled

- From learning to forwarding or to disabled
- From forwarding to disabled
- From disabled to blocking

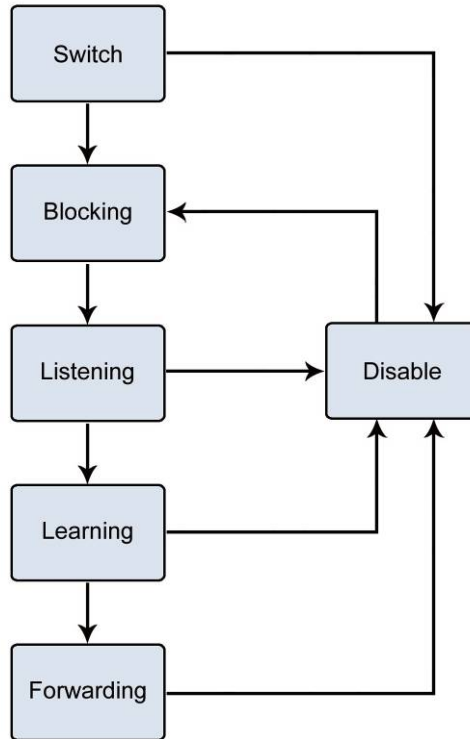

Figure 4-6-1 STP Port State Transitions

You can modify each port state by using management software. When you enable STP, every port on every switch in the network goes through the blocking state and then transitions through the states of listening and learning at power up. If properly configured, each port stabilizes to the forwarding or blocking state. No packets (except BPDUs) are forwarded from, or received by, STP enabled ports until the forwarding state is enabled for that port.

2. STP Parameters

STP Operation Levels

The Switch allows for two levels of operation: the switch level and the port level. The switch level forms a spanning tree consisting of links between one or more switches. The port level constructs a spanning tree consisting of groups of one or more ports. The STP operates in much the same way for both levels.



Note

On the switch level, STP calculates the Bridge Identifier for each switch and then sets the Root Bridge and the Designated Bridges. On the port level, STP sets the Root Port and the Designated Ports.

The following are the user-configurable STP parameters for the switch level:

| Parameter | Description | Default Value |
|---|--|---------------|
| Bridge Identifier (Not user configurable except by setting priority below) | A combination of the User-set priority and the switch's MAC address. The Bridge Identifier consists of two parts: a 16-bit priority and a 48-bit Ethernet MAC address 32768 + MAC | 32768 + MAC |
| Priority | A relative priority for each switch – lower numbers give a higher priority and a greater chance of a given switch being elected as the root bridge | 32768 |
| Hello Time | The length of time between broadcasts of the hello message by the switch | 2 seconds |
| Maximum Age Timer | Measures the age of a received BPDU for a port and ensures that the BPDU is discarded when its age exceeds the value of the maximum age timer. | 20 seconds |
| Forward Delay Timer | The amount time spent by a port in the learning and listening states waiting for a BPDU that may return the port to the blocking state. | 15 seconds |

The following are the user-configurable STP parameters for the port or port group level:

| Variable | Description | Default Value |
|----------------------|---|---|
| Port Priority | A relative priority for each port –lower numbers give a higher priority and a greater chance of a given port being elected as the root port | 128 |
| Port Cost | A value used by STP to evaluate paths – STP calculates path costs and selects the path with the minimum cost as the active path | 200,000-100Mbps Fast Ethernet ports 20,000-1000Mbps Gigabit Ethernet ports 0 - Auto |

Default Spanning-Tree Configuration

| Feature | Default Value |
|-----------------|----------------------------|
| Enable state | STP disabled for all ports |
| Port priority | 128 |
| Port cost | 0 |
| Bridge priority | 32,768 |

User-Changeable STA Parameters

The Switch's factory default setting should cover the majority of installations. However, it is advisable to keep the default settings as set at the factory; unless, it is absolutely necessary. The user changeable parameters in the Switch are as follows:

Priority – A Priority for the switch can be set from 0 to 65535. 0 is equal to the highest Priority.

Hello Time – The Hello Time can be from 1 to 10 seconds. This is the interval between two transmissions of BPDU packets sent by the Root Bridge to tell all other Switches that it is indeed the Root Bridge. If you set a Hello Time for your Switch, and it is not the Root Bridge, the set Hello Time will be used if and when your Switch becomes the Root Bridge.

| | |
|---|---|
|  Note | The Hello Time cannot be longer than the Max. Age. Otherwise, a configuration error will occur. |
|---|---|

Max. Age – The Max Age can be from 6 to 40 seconds. At the end of the Max Age, if a BPDU has still not been received from the Root Bridge, your Switch will start sending its own BPDU to all other Switches for permission to become the Root Bridge. If it turns out that your Switch has the lowest Bridge Identifier, it will become the Root Bridge.

Forward Delay Timer – The Forward Delay can be from 4 to 30 seconds. This is the time any port on the Switch spends in the listening state while moving from the blocking state to the forwarding state.

| | |
|---|--|
|  Note | Observe the following formulas when setting the above parameters: Max. Age _ 2 x (Forward Delay - 1 second) Max. Age _ 2 x (Hello Time + 1 second) |
|---|--|

Port Priority – A Port Priority can be from 0 to 240. The lower the number, the greater the probability the port will be chosen as the Root Port.

Port Cost – A Port Cost can be set from 0 to 200000000. The lower the number, the greater the probability the port will be chosen to forward packets.

3. Illustration of STP

A simple illustration of three switches connected in a loop is depicted in the below diagram. In this example, you can anticipate some major network problems if the STP assistance is not applied.

If switch A broadcasts a packet to switch B, switch B will broadcast it to switch C, and switch C will broadcast it to back to switch A and so on. The broadcast packet will be passed indefinitely in a loop, potentially causing a network failure. In this example, STP breaks the loop by blocking the connection between switch B and C. The decision to block a particular connection is based on the STP calculation of the most current Bridge and Port settings.

Now, if switch A broadcasts a packet to switch C, then switch C will drop the packet at port 2 and the broadcast will end there. Setting-up STP using values other than the defaults, can be complex. Therefore, you are advised to keep the default factory settings and STP will automatically assign root bridges/ports and block loop connections. Influencing STP to choose a particular switch as the root bridge using the Priority setting, or influencing STP to choose a particular port to block using the Port Priority and Port Cost settings is, however, relatively straight forward.

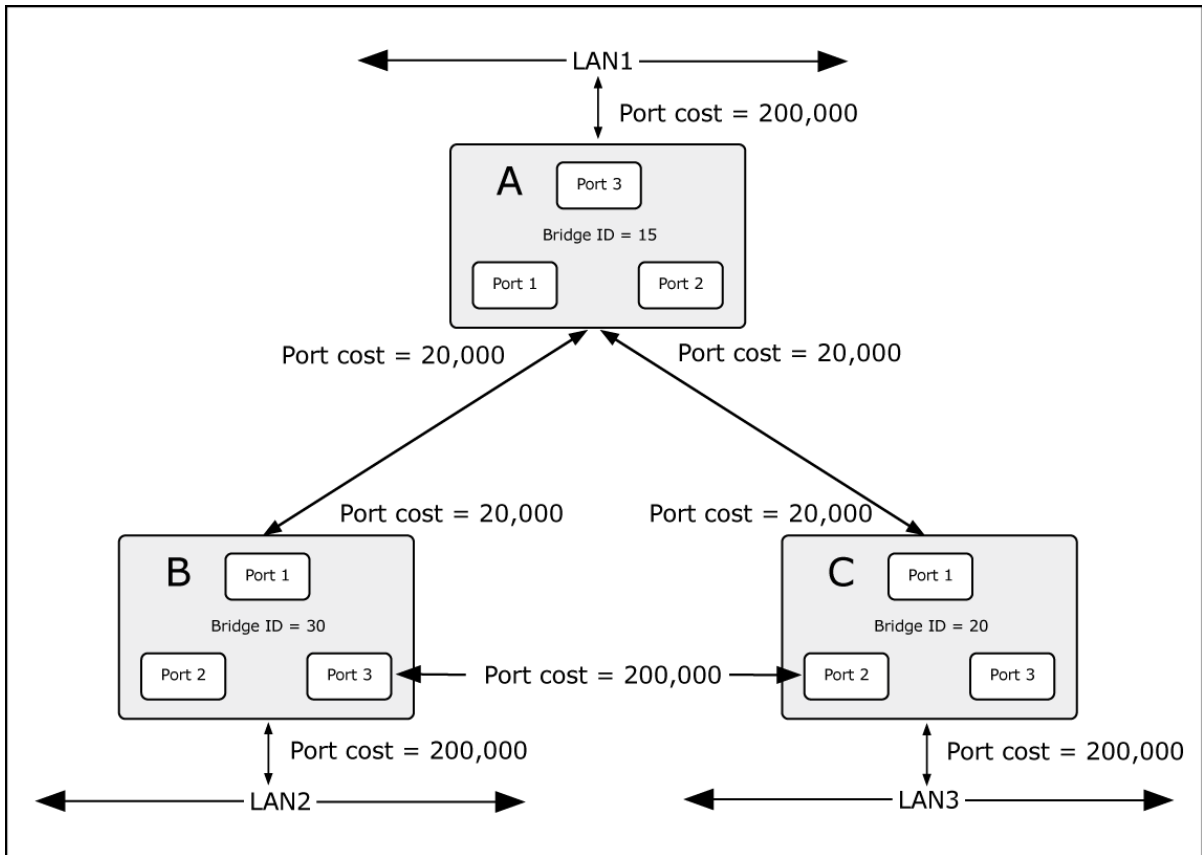

Figure 4-6-2 Before Applying the STA Rules

In this example, only the default STP values are used.

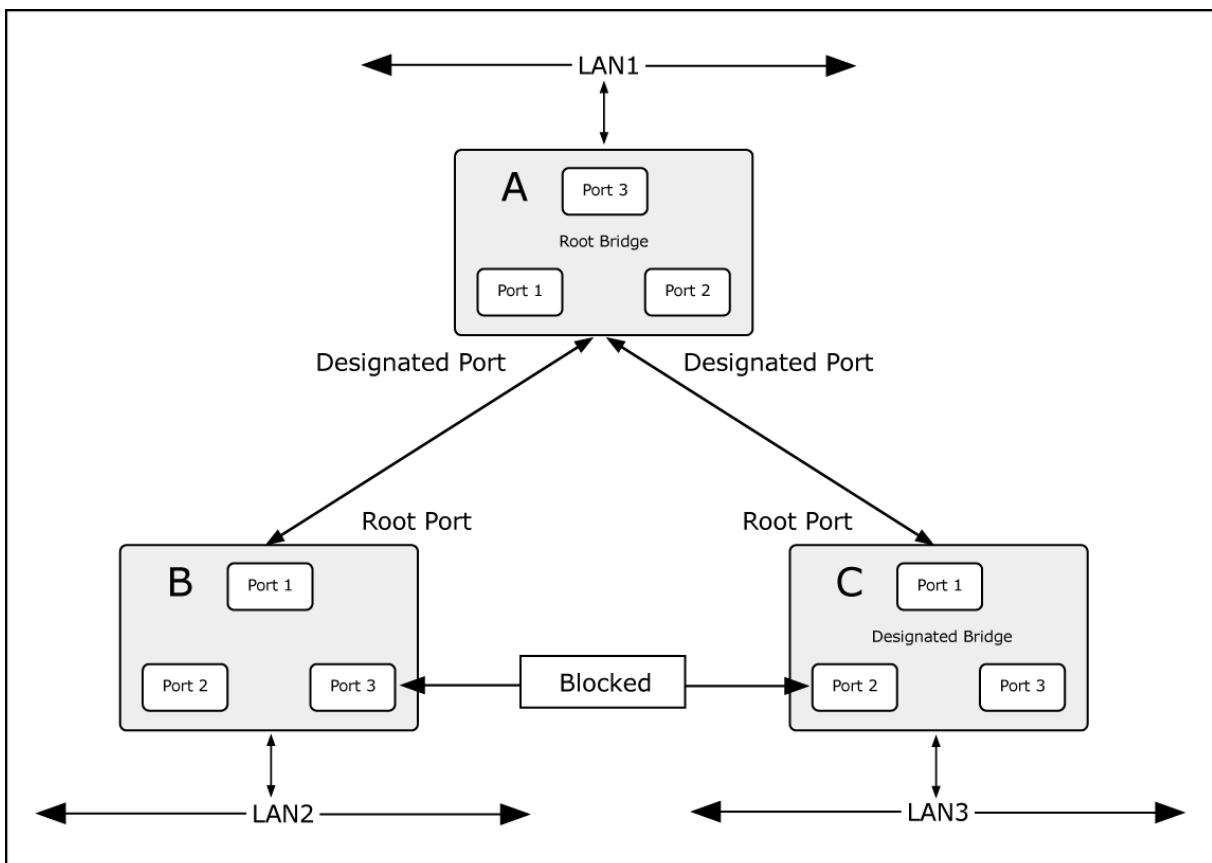

Figure 4-6-3 After Applying the STA Rules

The switch with the lowest Bridge ID (switch C) was elected the root bridge, and the ports were selected to give a high port cost between switches B and C. The two (optional) Gigabit ports (default port cost = 20,000) on switch A are connected to one (optional) Gigabit port on both switch B and C. The redundant link between switch B and C is deliberately chosen as a 100 Mbps Fast Ethernet link (default port cost = 200,000). Gigabit ports could be used, but the port cost should be increased from the default to ensure that the link between switch B and switch C is the blocked link.

This section has the following items:

- | | |
|--------------------------------|--------------------------------------|
| ■ STP Global Setting | Configures STP system settings |
| ■ STP Port Setting | Configures per port STP setting |
| ■ CIST Instance Setting | Configures system configuration |
| ■ CIST Port Setting | Configures CIST port setting |
| ■ MST Instance Setting | Configures each MST instance setting |
| ■ MST Port Setting | Configures per port MST setting |
| ■ STP Statistics | Displays the STP statistics |

4.6.2 STP Global Settings

This page allows you to configure STP system settings. The settings are used by all STP Bridge instances in the Switch. The LRP Managed Switch support the following Spanning Tree Protocols:

- **Compatible -- Spanning Tree Protocol (STP):** Provides a single path between end stations, avoiding and eliminating loops.
- **Normal -- Rapid Spanning Tree Protocol (RSTP):** Detects and uses network topologies that provide faster spanning tree convergence, without creating forwarding loops.
- **Extension – Multiple Spanning Tree Protocol (MSTP):** Defines an extension to RSTP to further develop the usefulness of virtual LANs (VLANs). This "Per-VLAN" Multiple Spanning Tree Protocol configures a separate Spanning Tree for each VLAN group and blocks all but one of the possible alternate paths within each Spanning Tree.

The STP Global Settings screens in [Figure 4-6-4](#) & [Figure 4-6-5](#) appear.

Global Setting

| | |
|-------------------------------|---|
| Enabled | <input type="radio"/> Enabled <input checked="" type="radio"/> Disabled |
| BPDU Forward | <input checked="" type="radio"/> flooding <input type="radio"/> filtering |
| PathCost Method | <input type="radio"/> short <input checked="" type="radio"/> long |
| Force Version | RSTP-Operation <input type="button" value="v"/> |
| Configuration Name | 00:00:30:4F:11:22 (Max.32 character) |
| Configuration Revision | 0 (0 - 65535) |

Figure 4-6-4 Global Settings Page Screenshot

The page includes the following fields:

| Object | Description |
|---------------------------------|---|
| • Enable | Enable or disable the STP function. The default value is "Disabled". |
| • BPDU Forward | Set the BPDU forward method. |
| • PathCost Method | The path cost method is used to determine the best path between devices. Therefore, lower values should be assigned to ports attached to faster media, and higher values assigned to ports with slower media. |
| • Force Version | The STP protocol version setting. Valid values are STP-Compatible , RSTP-Operation and MSTP-Operation . |
| • Configuration Name | Identifier used to identify the configuration currently being used. |
| • Configuration Revision | Identifier used to identify the configuration currently being used. The values allowed are between 0 and 65535. The default value is 0 . |

Buttons

: Click to apply changes.

STP Informations

| Information Name | Information Value |
|------------------------|-------------------|
| STP | Disabled |
| BPDU Forward | flooding |
| Cost Method | long |
| Force Version | RSTP-Operation |
| Configuration Name | 00:00:30:4F:11:22 |
| Configuration Revision | 0 |

Figure 4-6-5 STP Information Page Screenshot

The page includes the following fields:

| Object | Description |
|--------------------------|--|
| • STP | Display the current STP state |
| • BPDU Forward | Display the current BPDU forward mode |
| • Cost Method | Display the current cost method |
| • Force Version | Display the current force version |
| • Configuration Name | Display the current configuration name |
| • Configuration Revision | Display the current configuration revision |

4.6.3 STP Port Setting

This page allows you to configure per port STP settings. The STP Port Setting screens in [Figure 4-6-6](#) & [Figure 4-6-7](#) appear.

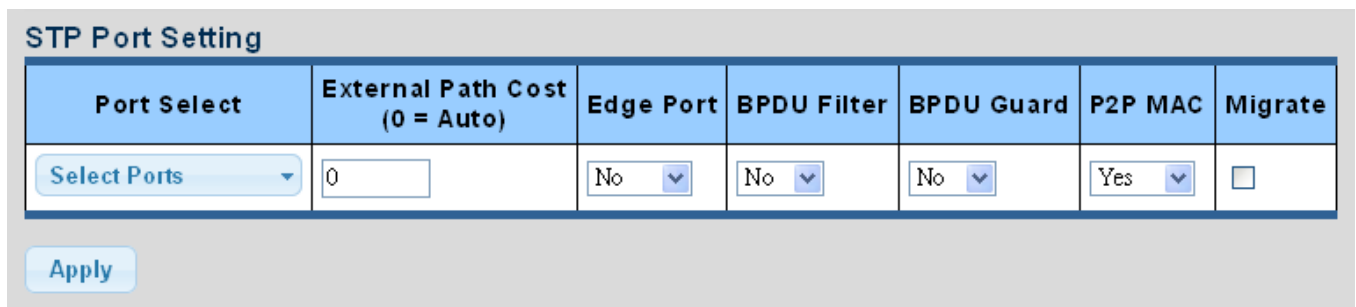

Figure 4-6-6 STP Port Configuration Page Screenshot

The page includes the following fields:

| Object | Description |
|----------------------------|--|
| • Port Select | Select port number from this drop-down list. |
| • External Cost (0 = Auto) | Controls the path cost incurred by the port. The Auto setting will set the path cost as appropriate by the physical link speed, using the 802.1D recommended values. Using the Specific setting, a user-defined value can be entered. The path cost is used when establishing the active topology of the network. Lower path cost ports are chosen as forwarding ports in favor of higher path cost ports. Valid values are in the range 1 to 200000000. |
| • Edge Port | Controls whether the operEdge flag should start as being set or cleared. (The initial operEdge state when a port is initialized). |
| • BPDU Filter | Control whether a port explicitly configured as Edge will transmit and receive BPDUs. |

| | |
|---|--|
| <ul style="list-style-type: none"> • BPDU Guard | <p>Control whether a port explicitly configured as Edge will disable itself upon reception of a BPDU. The port will enter the error-disabled state, and will be removed from the active topology.</p> |
| <ul style="list-style-type: none"> • P2P MAC | <p>Controls whether the port connects to a point-to-point LAN rather than a shared medium. This can be automatically determined, or forced either true or false. Transition to the forwarding state is faster for point-to-point LANs than for shared media. (This applies to physical ports only. Aggregations are always <i>forced Point2Point</i>).</p> |
| <ul style="list-style-type: none"> • Migrate | <p>If at any time the switch detects STP BPDUs, including Configuration or Topology Change Notification BPDUs, it will automatically set the selected interface to forced STP-compatible mode. However, you can also use the Protocol Migration button to manually re-check the appropriate BPDU format (RSTP or STP-compatible) to send on the selected interfaces. (Default: Disabled)</p> |

Buttons

 : Click to apply changes.

By default, the system automatically detects the speed and duplex mode used on each port, and configures the path cost according to the values shown below. Path cost "0" is used to indicate auto-configuration mode. When the short path cost method is selected and the default path cost recommended by the IEEE 802.1w standard exceeds 65,535, the default is set to 65,535.

| Port Type | IEEE 802.1D-1998 | IEEE 802.1w-2001 |
|-------------------------|------------------|--------------------|
| Ethernet | 50-600 | 200,000-20,000,000 |
| Fast Ethernet | 10-60 | 20,000-2,000,000 |
| Gigabit Ethernet | 3-10 | 2,000-200,000 |

Table 4-6-1 Recommended STP Path Cost Range

| Port Type | Link Type | IEEE 802.1D-1998 | IEEE 802.1w-2001 |
|-------------------------|-------------|------------------|------------------|
| Ethernet | Half Duplex | 100 | 2,000,000 |
| | Full Duplex | 95 | 1,999,999 |
| | Trunk | 90 | 1,000,000 |
| Fast Ethernet | Half Duplex | 19 | 200,000 |
| | Full Duplex | 18 | 100,000 |
| | Trunk | 15 | 50,000 |
| Gigabit Ethernet | Full Duplex | 4 | 10,000 |
| | Trunk | 3 | 5,000 |

Table 4-6-2 Recommended STP Path Costs

| Port Type | Link Type | IEEE 802.1w-2001 |
|------------------|-------------|------------------|
| Ethernet | Half Duplex | 2,000,000 |
| | Full Duplex | 1,000,000 |
| | Trunk | 500,000 |
| Fast Ethernet | Half Duplex | 200,000 |
| | Full Duplex | 100,000 |
| | Trunk | 50,000 |
| Gigabit Ethernet | Full Duplex | 10,000 |
| | Trunk | 5,000 |

Table 4-6-3 Default STP Path Costs

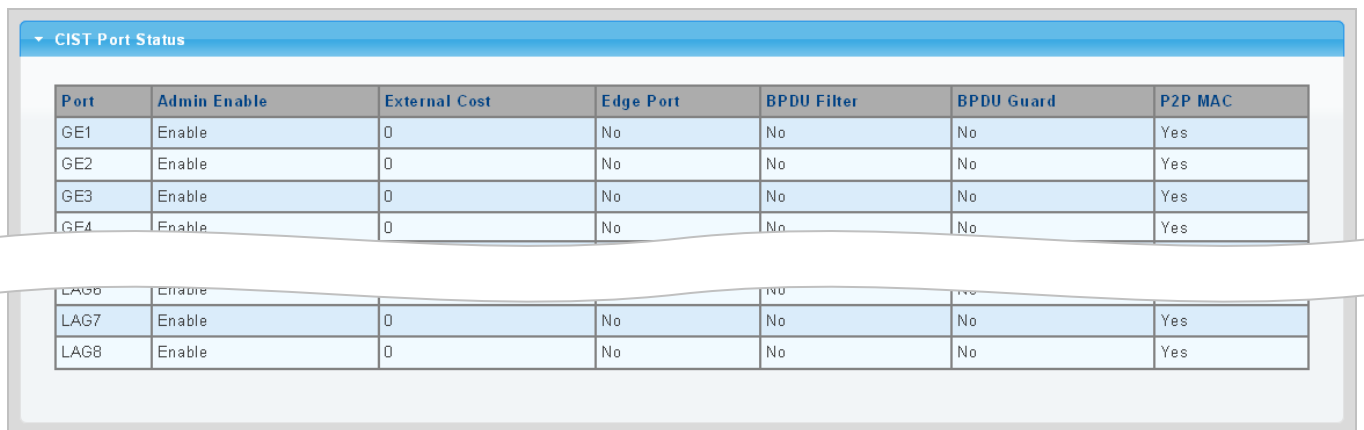

| Port | Admin Enable | External Cost | Edge Port | BPDU Filter | BPDU Guard | P2P MAC |
|------|--------------|---------------|-----------|-------------|------------|---------|
| GE1 | Enable | 0 | No | No | No | Yes |
| GE2 | Enable | 0 | No | No | No | Yes |
| GE3 | Enable | 0 | No | No | No | Yes |
| GE4 | Enable | 0 | No | No | No | Yes |
| LAG6 | Enable | 0 | No | No | No | Yes |
| LAG7 | Enable | 0 | No | No | No | Yes |
| LAG8 | Enable | 0 | No | No | No | Yes |

Figure 4-6-7 STP Port Status Page Screenshot

The page includes the following fields:

| Object | Description |
|-----------------|---|
| • Port | The switch port number of the logical STP port. |
| • Admin Enable | Display the current STP port mode status |
| • External Cost | Display the current external cost. |
| • Edge Port | Display the current edge port status. |
| • BPDU Filter | Display the current BPDU filter configuration. |
| • BPDU Guard | Display the current BPDU guard configuration. |
| • P2P MAC | Display the current P2P MAC status. |

4.6.4 CIST Instance Setting

This Page allows you to configure CIST instance settings. The CIST Instance Setting and Information screens in [Figure 4-6-8](#) & [Figure 4-6-9](#) appear.

CIST Instance Setting

| | |
|----------------------|--|
| Priority | 32768 <input type="button" value="v"/> |
| Max Hops | <input type="text" value="20"/> (1-40) |
| Forward Delay | <input type="text" value="15"/> (4-30) |
| Max Age | <input type="text" value="20"/> (6-40) |
| Tx Hold Count | <input type="text" value="6"/> (1-10) |
| Hello Time | <input type="text" value="2"/> (1-10) |

Figure 4-6-8: CIST Instance Setting Page Screenshot

The page includes the following fields:

| Object | Description |
|--|---|
| <ul style="list-style-type: none"> Priority | <p>Controls the bridge priority. Lower numeric values have better priority. The bridge priority plus the MSTI instance number, concatenated with the 6-byte MAC address of the switch forms a Bridge Identifier.</p> <p>For MSTP operation, this is the priority of the CIST. Otherwise, this is the priority of the STP/RSTP bridge.</p> |
| <ul style="list-style-type: none"> Max Hops | <p>This defines the initial value of remaining Hops for MSTI information generated at the boundary of an MSTI region. It defines how many bridges a root bridge can distribute its BPDU information. Valid values are in the range 6 to 40 hops.</p> |
| <ul style="list-style-type: none"> Forward Delay | <p>The delay used by STP Bridges to transition Root and Designated Ports to Forwarding (used in STP compatible mode). Valid values are in the range 4 to 30 seconds</p> <p>-Default: 15</p> <p>-Minimum: The higher of 4 or [(Max. Message Age / 2) + 1]</p> <p>-Maximum: 30</p> |
| <ul style="list-style-type: none"> Max Age | <p>The maximum age of the information transmitted by the Bridge when it is the Root Bridge. Valid values are in the range 6 to 40 seconds.</p> <p>-Default: 20</p> <p>-Minimum: The higher of 6 or [2 x (Hello Time + 1)].</p> <p>-Maximum: The lower of 40 or [2 x (Forward Delay -1)]</p> |

| | |
|--|--|
| <ul style="list-style-type: none"> • Tx Hold Count | The number of BPDU's a bridge port can send per second. When exceeded, transmission of the next BPDU will be delayed. Valid values are in the range 1 to 10 BPDU's per second. |
| <ul style="list-style-type: none"> • Hello Time | The time that controls the switch to send out the BPDU packet to check STP current status. Enter a value between 1 through 10. |

Buttons



: Click to apply changes.

▼ CIST Instance Information

| Information Name | Information Value |
|------------------|-------------------|
| Priority | 32768 |
| Max Hops | 20 |
| Forward Delay | 15 |
| Max Age | 20 |
| Tx Hold Count | 6 |
| Hello Time | 2 |

Figure 4-6-9 CIST Instance Information Page Screenshot

The page includes the following fields:

| Object | Description |
|--|-----------------------------------|
| <ul style="list-style-type: none"> • Priority | Display the current CIST priority |
| <ul style="list-style-type: none"> • Max Hop | Display the current max. hop |
| <ul style="list-style-type: none"> • Forward Delay | Display the current forward delay |
| <ul style="list-style-type: none"> • Max. Age | Display the current max. age |
| <ul style="list-style-type: none"> • Tx Hold Count | Display the current Tx hold count |
| <ul style="list-style-type: none"> • Hello Time | Display the current hello time |

4.6.5 CIST Port Setting

This page allows you to configure per port CIST priority and cost. The CIST Port Setting and Status screens in [Figure 4-6-10](#) & [Figure 4-6-11](#) appear.

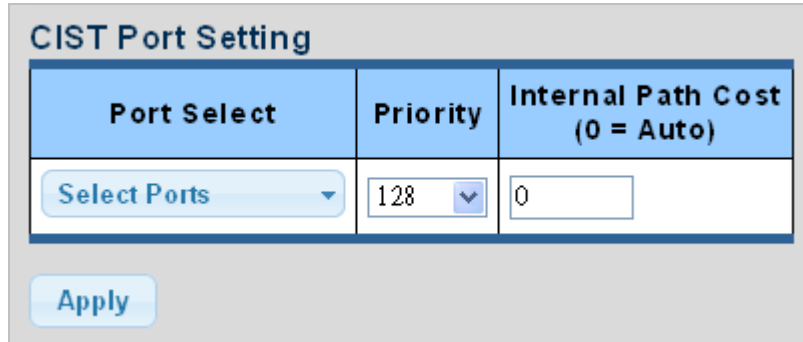

Figure 4-6-10 CIST Port Setting Page Screenshot

The page includes the following fields:

| Object | Description |
|--|---|
| <ul style="list-style-type: none"> • Port Select | Select port number from this drop-down list. |
| <ul style="list-style-type: none"> • Priority | <p>Controls the port priority. This can be used to control priority of ports having identical port cost. (See above).</p> <p>Default: 128</p> <p>Range: 0-240, in steps of 16</p> |
| <ul style="list-style-type: none"> • Internal Path Cost (0 = Auto) | <p>Controls the path cost incurred by the port. The Auto setting will set the path cost as appropriate by the physical link speed, using the 802.1D recommended values. Using the Specific setting, a user-defined value can be entered. The path cost is used when establishing the active topology of the network. Lower path cost ports are chosen as forwarding ports in favor of higher path cost ports. Valid values are in the range 1 to 200000000.</p> |

Buttons



: Click to apply changes.

| CIST Port Status | | | | | | | | | | | | | |
|------------------|---------------------------------|------------------------------|------------------------------|------------------------|--------------------|-----------------------|--------------------|-----------------------|-------------------------|---------------------|-------------------|-----------|------------|
| Port | Identifier (Priority / Port ID) | External Path Cost Conf/Oper | Internal Path Cost Conf/Oper | Designated Root Bridge | External Root Cost | Regional Root Bridge | Internal Root Cost | Designated Bridge | Internal Port Path Cost | Edge Port Conf/Oper | P2P MAC Conf/Oper | Port Role | Port State |
| GE1 | 128 / 1 | 0 / 20000 | 0 / 20000 | 0 / 00:00:00:00:00:00 | 0 | 0 / 00:00:00:00:00:00 | 0 | 0 / 00:00:00:00:00:00 | 20000 | No / No | Auto / No | Disabled | Disabled |
| GE2 | 128 / 2 | 0 / 20000 | 0 / 20000 | 0 / 00:00:00:00:00:00 | 0 | 0 / 00:00:00:00:00:00 | 0 | 0 / 00:00:00:00:00:00 | 20000 | No / No | Auto / No | Disabled | Disabled |
| GE3 | 128 / 3 | 0 / 20000 | 0 / 20000 | 0 / 00:00:00:00:00:00 | 0 | 0 / 00:00:00:00:00:00 | 0 | 0 / 00:00:00:00:00:00 | 20000 | No / No | Auto / No | Disabled | Disabled |
| GE4 | 128 / 4 | 0 / 20000 | 0 / 20000 | 0 / 00:00:00:00:00:00 | 0 | 0 / 00:00:00:00:00:00 | 0 | 0 / 00:00:00:00:00:00 | 20000 | No / No | Auto / No | Disabled | Disabled |
| LAG6 | 128 / 16 | 0 / 20000 | 0 / 20000 | 0 / 00:00:00:00:00:00 | 0 | 0 / 00:00:00:00:00:00 | 0 | 0 / 00:00:00:00:00:00 | 20000 | No / No | Auto / No | Disabled | Disabled |
| LAG7 | 128 / 17 | 0 / 20000 | 0 / 20000 | 0 / 00:00:00:00:00:00 | 0 | 0 / 00:00:00:00:00:00 | 0 | 0 / 00:00:00:00:00:00 | 20000 | No / No | Auto / No | Disabled | Disabled |
| LAG8 | 128 / 18 | 0 / 20000 | 0 / 20000 | 0 / 00:00:00:00:00:00 | 0 | 0 / 00:00:00:00:00:00 | 0 | 0 / 00:00:00:00:00:00 | 20000 | No / No | Auto / No | Disabled | Disabled |

Figure 4-6-11 CIST Port Status Page Screenshot

The page includes the following fields:

| Object | Description |
|-----------------------------------|---|
| • Port | The switch port number of the logical STP port |
| • Identifier (Priority / Port ID) | Display the current identifier (Priority / Port ID) |
| • External Path Cost Conf/Oper | Display the current external path cost conf/oper |
| • Internal Path Cost Conf/Oper | Display the current internal path cost/oper |
| • Designated Root Bridge | Display the current designated root bridge |
| • External Root Cost | Display the current external root cost |
| • Regional Root Bridge | Display the current regional root bridge |
| • Internal Root Cost | Display the current internal root cost |
| • Designated Bridge | Display the current designated bridge |
| • Internal Port Path Cost | Display the current internal port path cost |
| • Edge Port Conf/Oper | Display the current edge port conf/oper |
| • P2P MAC Conf/Oper | Display the current P2P MAC conf/oper |
| • Port Role | Display the current port role |
| • Port State | Display the current port state |

4.6.6 MST Instance Configuration

This page allows the user to configure MST Instance Configuration. The MST Instance Setting, Information and Status screens in Figure 4-6-12, Figure 4-6-13 & Figure 4-6-14 appear.

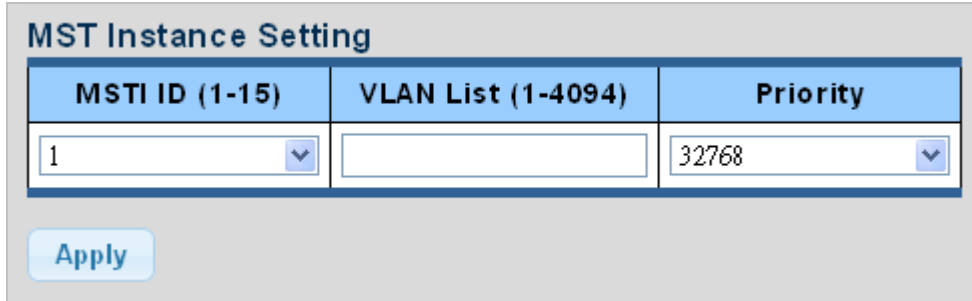

| MSTI ID (1-15) | VLAN List (1-4094) | Priority |
|----------------|--------------------|----------|
| 1 | | 32768 |

Apply

Figure 4-6-12 MST Instance Setting Page Screenshot

The page includes the following fields:

| Object | Description |
|----------------------|---|
| • MSTI ID | Allow to assign MSTI ID. The range for the MSTI ID is 1-15. |
| • VLAN List (1-4096) | Allow to assign VLAN list to special MSTI ID. The range for the VLAN list is 1-4094. |
| • Priority | Controls the bridge priority. Lower numerical values have better priority. The bridge priority plus the MSTI instance number, concatenated with the 6-byte MAC address of the switch forms a Bridge Identifier. |

Buttons

: Click to apply changes.

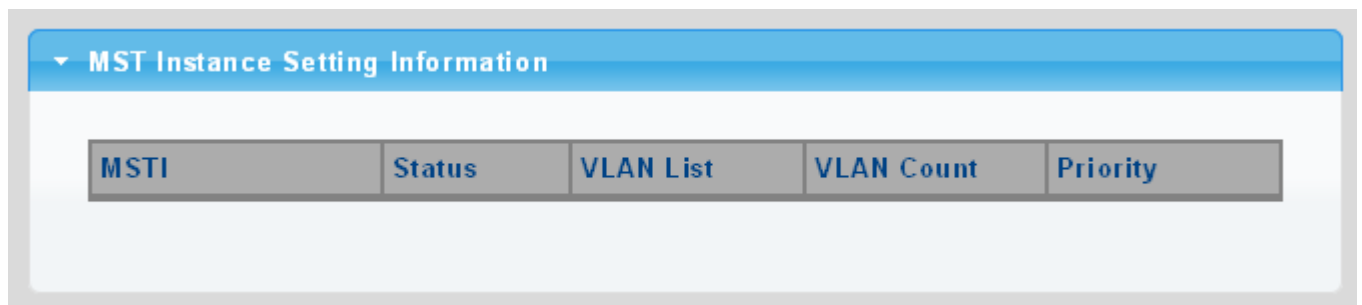

| MST Instance Setting Information | | | | |
|----------------------------------|--------|-----------|------------|----------|
| MSTI | Status | VLAN List | VLAN Count | Priority |

Figure 4-6-13 MSTI Instance Setting Information Page Screenshot

The page includes the following fields:

| Object | Description |
|--------------|-----------------------------------|
| • MSTI | Display the current MSTI entry |
| • Status | Display the current MSTI status |
| • VLAN List | Display the current VLAN list |
| • VLAN Count | Display the current VLAN count |
| • Priority | Display the current MSTI priority |

▼ **MST Instance Status**

| Information Name | Information Value |
|----------------------|-------------------|
| MSTI ID | 1 |
| Regional Root Bridge | --/-- |
| Internal Root Cost | --/-- |
| Designated Bridge | --/-- |
| Root Port | --/-- |
| Max Age | --/-- |
| Forward Delay | --/-- |
| Remainging Hops | --/-- |
| Last Topology Change | --/-- |

Figure 4-6-14 MST Instance Status Page Screenshot

The page includes the following fields:

| Object | Description |
|-------------------------------|--|
| • MSTI ID | Display the MSTI ID. |
| • Regional Root Bridge | Display the current designated root bridge |
| • Internal Root Cost | Display the current internal root cost |
| • Designated Bridge | Display the current designated bridge |
| • Root Port | Display the current root port. |
| • Max. Age | Display the current max. age. |
| • Forward Delay | Display the current forward delay. |
| • Remaining Hops | Display the current remaining hops. |
| • Last Topology Change | Display the current last topology change. |

4.6.7 MST Port Setting

This page allows the user to inspect the current STP MSTI port configurations, and possibly change them as well.

A MSTI port is a virtual port, which is instantiated separately for each active CIST (physical) port for each MSTI instance configured and applicable for the port. The MSTI instance must be selected before displaying actual MSTI port configuration options.

This page contains MSTI port settings for physical and aggregated ports. The aggregation settings are global. The MSTI Ports Setting screens in [Figure 4-6-15](#) & [Figure 4-6-16](#) appear.

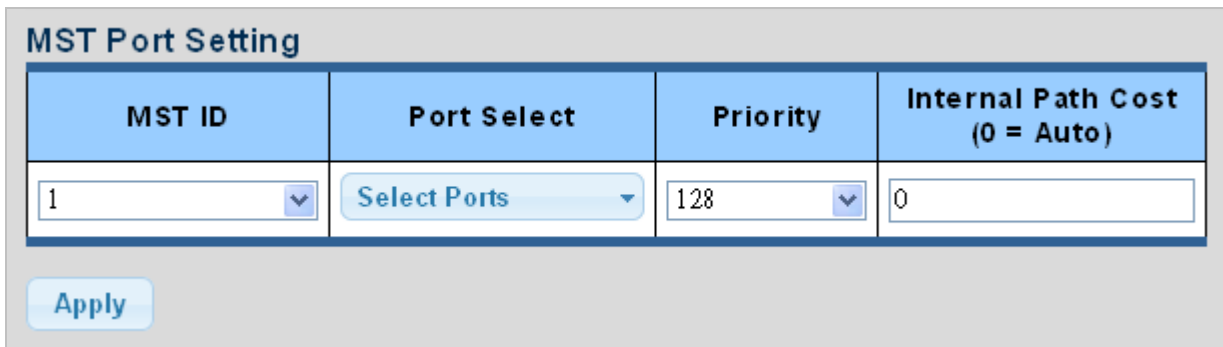



Figure 4-6-15 MST Port Configuration Page Screenshot

The page includes the following fields:

| Object | Description |
|--|---|
| <ul style="list-style-type: none"> • MST ID | Enter the special MST ID to configure path cost and priority. |
| <ul style="list-style-type: none"> • Port Select | Select port number from this drop-down list. |
| <ul style="list-style-type: none"> • Priority | Controls the port priority. This can be used to control priority of ports having identical port cost. |
| <ul style="list-style-type: none"> • Internal Path Cost (0 = Auto) | <p>Controls the path cost incurred by the port.</p> <p>The Auto setting will set the path cost as appropriate by the physical link speed, using the 802.1D recommended values. Using the Specific setting, a user-defined value can be entered.</p> <p>The path cost is used when establishing the active topology of the network. Lower path cost ports are chosen as forwarding ports in favor of higher path cost ports.</p> <p>Valid values are in the range 1 to 200000000.</p> |

Buttons

: Click to apply changes.

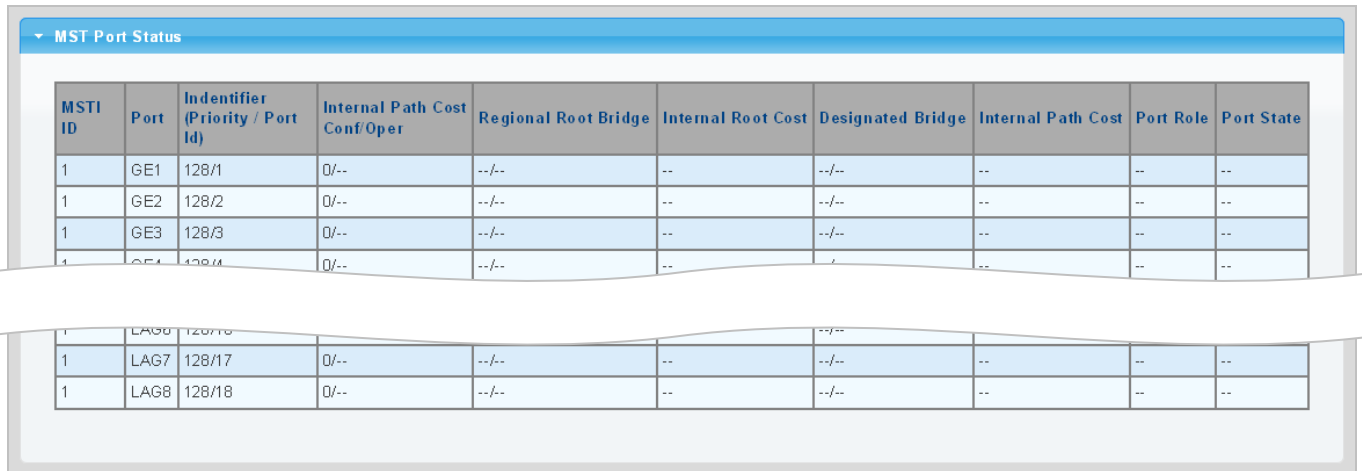

| MSTI ID | Port | Identifier (Priority / Port Id) | Internal Path Cost Conf/Oper | Regional Root Bridge | Internal Root Cost | Designated Bridge | Internal Path Cost | Port Role | Port State |
|---------|------|---------------------------------|------------------------------|----------------------|--------------------|-------------------|--------------------|-----------|------------|
| 1 | GE1 | 128/1 | 0/-- | --/-- | -- | --/-- | -- | -- | -- |
| 1 | GE2 | 128/2 | 0/-- | --/-- | -- | --/-- | -- | -- | -- |
| 1 | GE3 | 128/3 | 0/-- | --/-- | -- | --/-- | -- | -- | -- |
| 1 | GE4 | 128/4 | 0/-- | --/-- | -- | --/-- | -- | -- | -- |
| 1 | LAG6 | 128/16 | 0/-- | --/-- | -- | --/-- | -- | -- | -- |
| 1 | LAG7 | 128/17 | 0/-- | --/-- | -- | --/-- | -- | -- | -- |
| 1 | LAG8 | 128/18 | 0/-- | --/-- | -- | --/-- | -- | -- | -- |

Figure 4-6-16 MST Port Status Page Screenshot

The page includes the following fields:

| Object | Description |
|--|--|
| • MSTI ID | Display the current MSTI ID |
| • Port | The switch port number of the logical STP port |
| • Identifier (Priority / Port ID) | Display the current identifier (priority / port ID) |
| • Internal Path Cost Conf/Oper | Display the current internal path cost configuration / operation |
| • Regional Root Bridge | Display the current regional root bridge |
| • Internal Root Cost | Display the current internal root cost |
| • Designated Bridge | Display the current designated bridge |
| • Internal Path Cost | Display the current internal path cost |
| • Port Role | Display the current port role |
| • Port State | Display the current port state |

4.6.8 STP Statistics

This page displays STP statistics. The STP statistics screen in [Figure 4-6-17](#) appears.

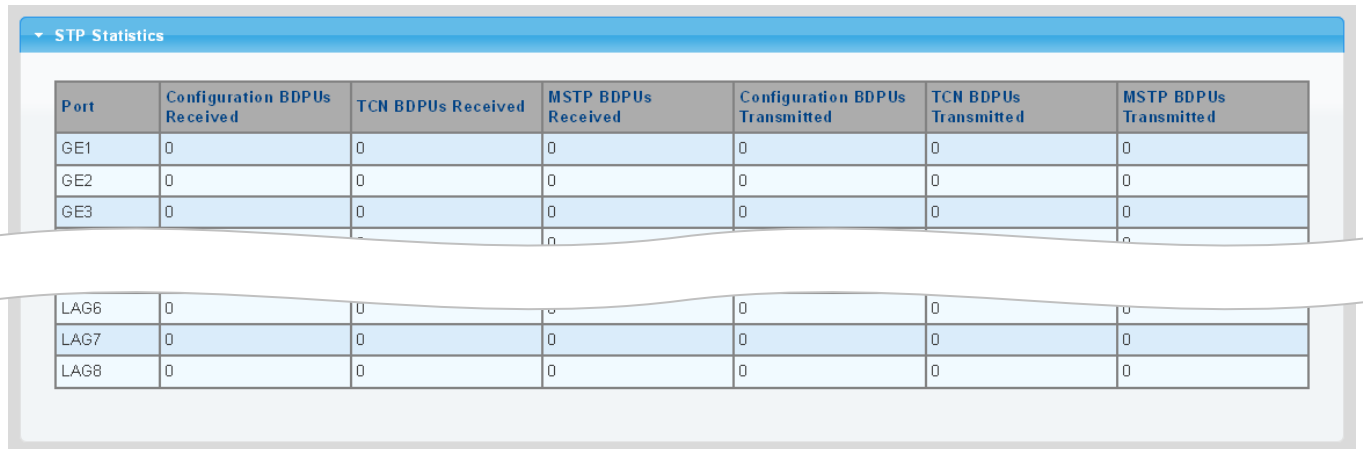

| Port | Configuration BPDUs Received | TCN BPDUs Received | MSTP BPDUs Received | Configuration BPDUs Transmitted | TCN BPDUs Transmitted | MSTP BPDUs Transmitted |
|------|------------------------------|--------------------|---------------------|---------------------------------|-----------------------|------------------------|
| GE1 | 0 | 0 | 0 | 0 | 0 | 0 |
| GE2 | 0 | 0 | 0 | 0 | 0 | 0 |
| GE3 | 0 | 0 | 0 | 0 | 0 | 0 |
| LAG6 | 0 | 0 | 0 | 0 | 0 | 0 |
| LAG7 | 0 | 0 | 0 | 0 | 0 | 0 |
| LAG8 | 0 | 0 | 0 | 0 | 0 | 0 |

Figure 4-6-17 STP Statistics Page Screenshot

The page includes the following fields:

| Object | Description |
|-----------------------------------|--|
| • Port | The switch port number of the logical STP port |
| • Configuration BPDUs Received | Display the current configuration BPDUs received |
| • TCN BPDUs Received | Display the current TCN BPDUs received |
| • MSTP BPDUs Received | Display the current MSTP BPDUs received |
| • Configuration BPDUs Transmitted | Display the configuration BPDUs transmitted |
| • TCN BPDUs Transmitted | Display the current TCN BPDUs transmitted |
| • MSTP BPDUs Transmitted | Display the current BPDUs transmitted |

4.7 Multicast

This section has the following items:

- **Properties** Configures multicast properties
- **IGMP Snooping** Configures IGMP snooping settings
- **IGMP Snooping Statistics** Displays the IGMP snooping statistics
- **MLD Snooping** Configures MLD snooping settings
- **MLD Snooping Statistics** Displays the MLD snooping statistics
- **Multicast Throttling Setting** Configures multicast throttling setting
- **Multicast Filter** Configures multicast filter

4.7.1 Properties

This page provides multicast properties related configuration.

The multicast Properties and Information screen in [Figure 4-7-1](#) & [Figure 4-7-2](#) appear.

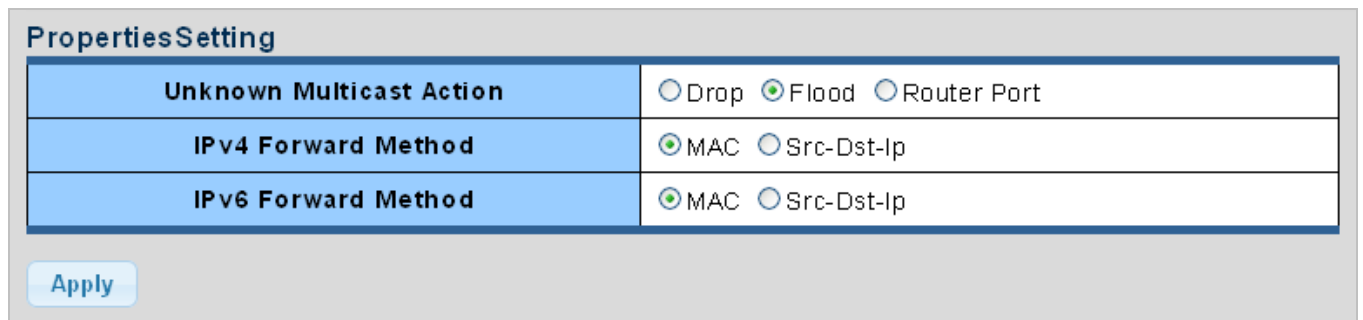

The screenshot shows a configuration page titled "PropertiesSetting". It contains three rows of settings, each with a label and radio button options:

| Label | Options |
|--------------------------|---|
| Unknown Multicast Action | <input type="radio"/> Drop <input checked="" type="radio"/> Flood <input type="radio"/> Router Port |
| IPv4 Forward Method | <input checked="" type="radio"/> MAC <input type="radio"/> Src-Dst-Ip |
| IPv6 Forward Method | <input checked="" type="radio"/> MAC <input type="radio"/> Src-Dst-Ip |

Below the settings is an "Apply" button.

Figure 4-7-1 Properties Setting Page Screenshot

The page includes the following fields:

| Object | Description |
|-----------------------------------|--|
| • Unknown Multicast Action | Unknown multicast traffic method: Drop , flood or send to router port . |
| • IPv4 Forward Method | Configure the IPv4 multicast forward method |
| • IPv6 Forward Method | Configure the IPv6 multicast forward method |

Buttons



: Click to apply changes.

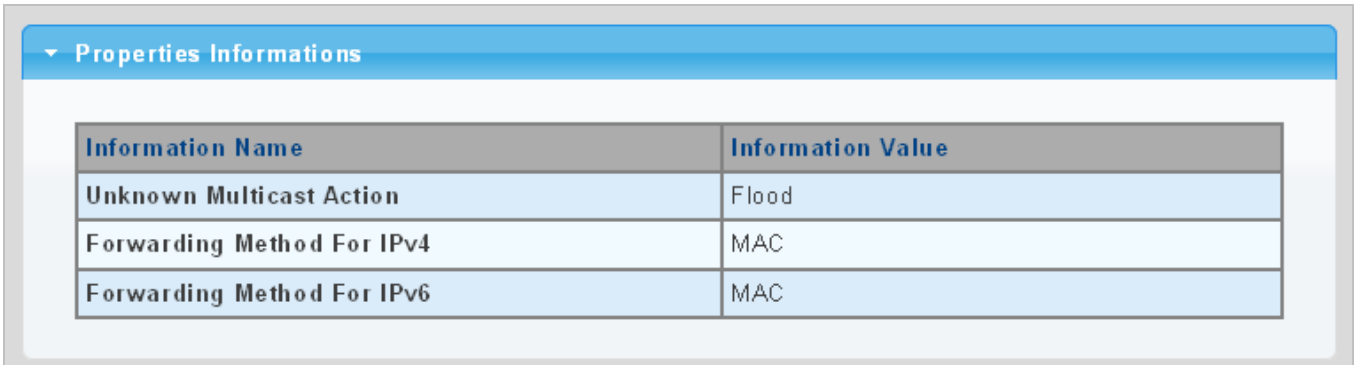

Figure 4-7-2 Properties Information Page Screenshot

The page includes the following fields:

| Object | Description |
|--|---|
| <ul style="list-style-type: none"> Unknown Multicast Action | Display the current unknown multicast action status |
| <ul style="list-style-type: none"> Forward Method For IPv4 | Display the current IPv4 multicast forward method |
| <ul style="list-style-type: none"> Forward Method For IPv6 | Display the current IPv6 multicast forward method |

4.7.2 IGMP Snooping

The **Internet Group Management Protocol (IGMP)** lets host and routers share information about multicast group memberships. IGMP snooping is a switch feature that monitors the exchange of IGMP messages and copies them to the CPU for feature processing. The overall purpose of IGMP Snooping is to limit the forwarding of multicast frames to only ports that are a member of the multicast group.

About the Internet Group Management Protocol (IGMP) Snooping

Computers and network devices that want to receive multicast transmissions need to inform nearby routers that they will become members of a multicast group. The **Internet Group Management Protocol (IGMP)** is used to communicate this information. IGMP is also used to periodically check the multicast group for members that are no longer active. In the case where there is more than one multicast router on a sub network, one router is elected as the 'queried'. This router then keeps track of the membership of the multicast groups that have active members. The information received from IGMP is then used to determine if multicast packets should be forwarded to a given sub network or not. The router can check, using IGMP, to see if there is at least one member of a multicast group on a given subnet work. If there are no members on a sub network, packets will not be forwarded to that sub network.

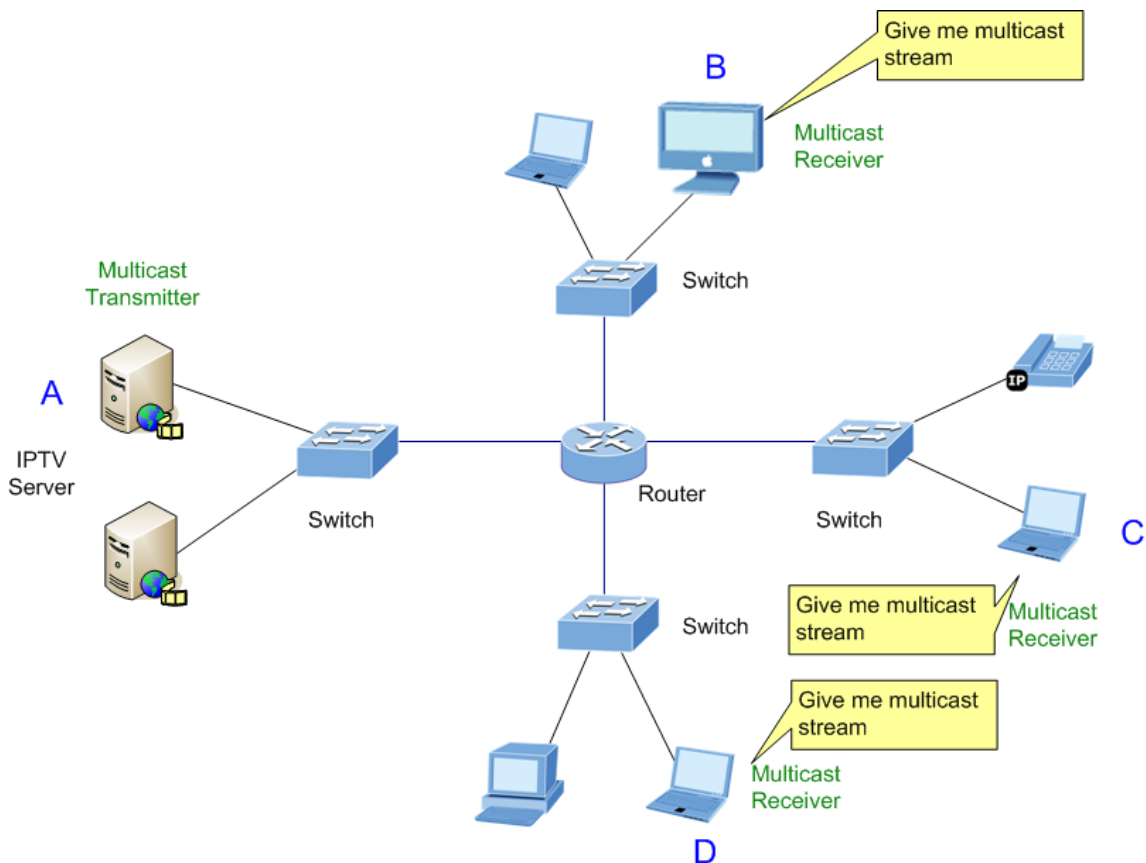

Figure 4-7-3 Multicast Service

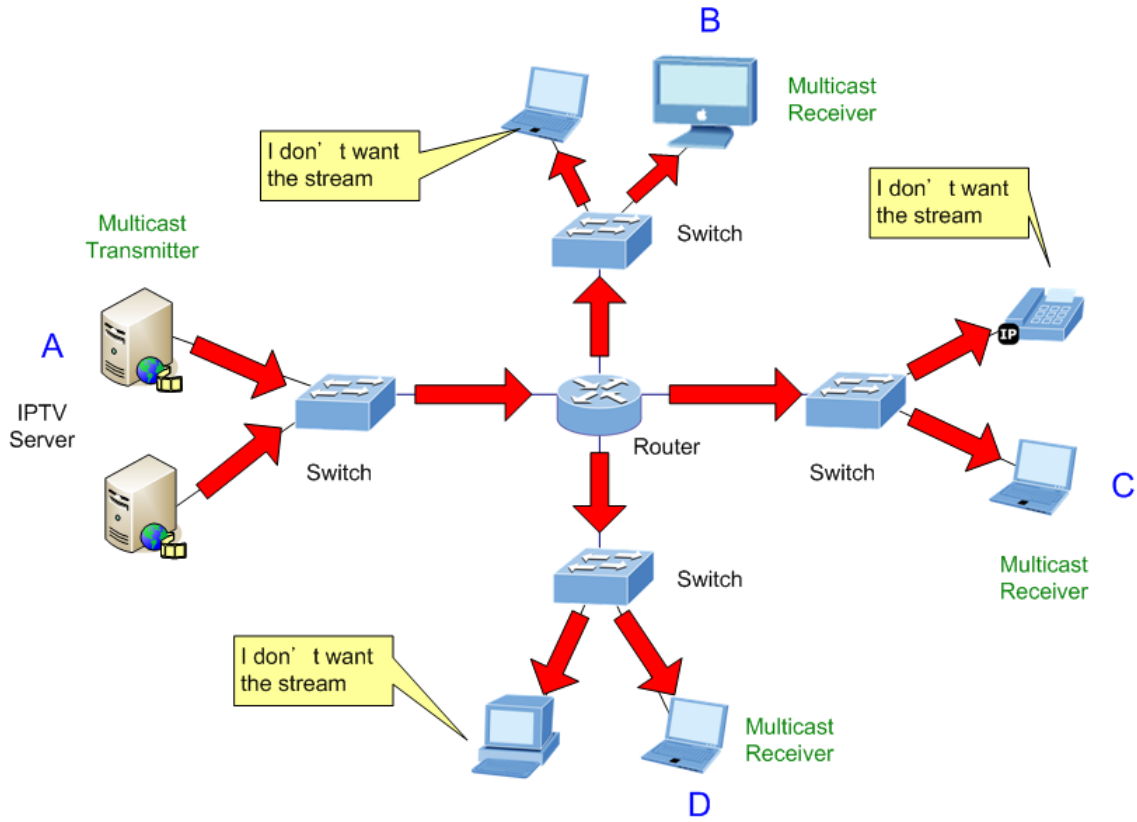

Figure 4-7-4 Multicast Flooding

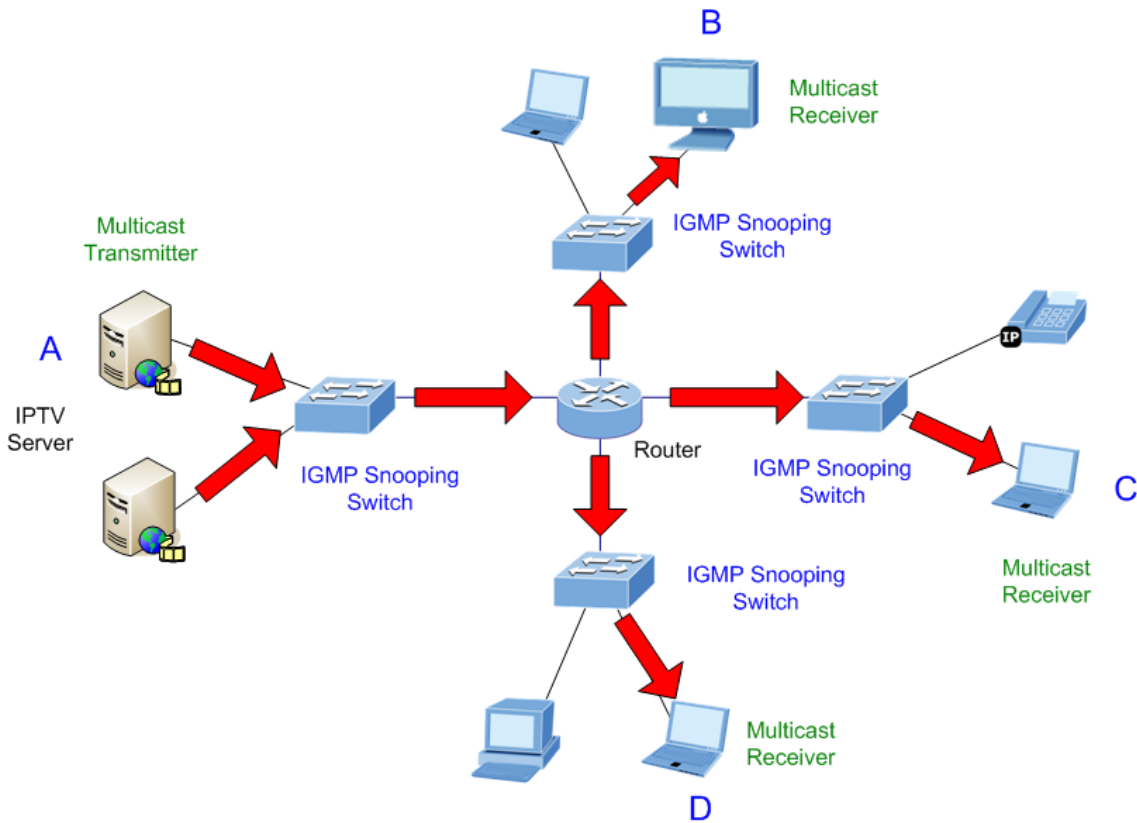

Figure 4-7-5 IGMP Snooping Multicast Stream Control

IGMP Versions 1 and 2

Multicast groups allow members to join or leave at any time. IGMP provides the method for members and multicast routers to communicate when joining or leaving a multicast group.

IGMP version 1 is defined in RFC 1112. It has a fixed packet size and no optional data.

The format of an IGMP packet is shown below:

IGMP Message Format

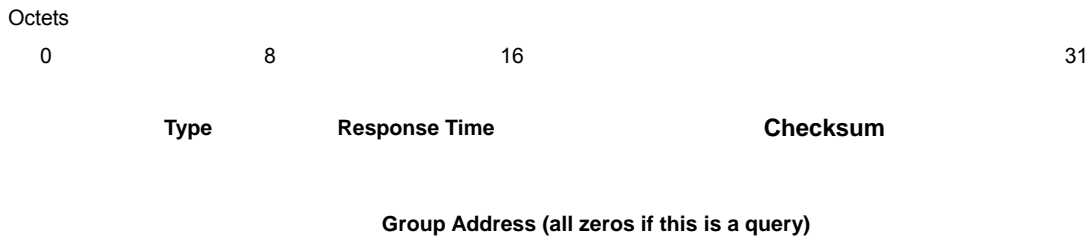

The IGMP Type codes are shown below:

| Type | Meaning |
|-------------|---|
| 0x11 | Membership Query (if Group Address is 0.0.0.0) |
| 0x11 | Specific Group Membership Query (if Group Address is Present) |
| 0x16 | Membership Report (version 2) |
| 0x17 | Leave a Group (version 2) |
| 0x12 | Membership Report (version 1) |

IGMP packets enable multicast routers to keep track of the membership of multicast groups, on their respective sub networks.

The following outlines what is communicated between a multicast router and a multicast group member using IGMP.

A host sends an IGMP “**report**” to join a group

A host will never send a report when it wants to leave a group (for version 1).

A host will send a “**leave**” report when it wants to leave a group (for version 2).

Multicast routers send IGMP queries (to the all-hosts group address: 224.0.0.1) periodically to see whether any group members exist on their sub networks. If there is no response from a particular group, the router assumes that there are no group members on the network.

The Time-to-Live (TTL) field of query messages is set to 1 so that the queries will not be forwarded to other sub networks.

IGMP version 2 introduces some enhancements such as a method to elect a multicast queried for each LAN, an explicit leave

message, and query messages that are specific to a given group.

The states a computer will go through to join or to leave a multicast group are shown below:

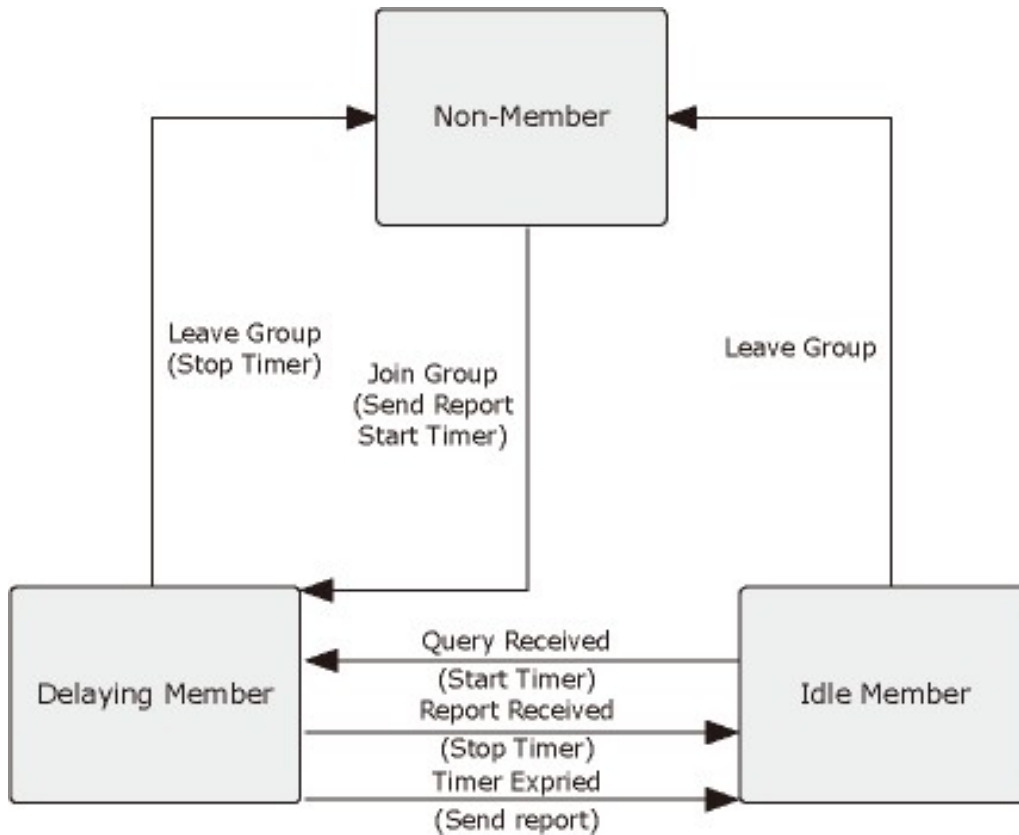

Figure 4-7-6 IGMP State Transitions

■ **IGMP Querier –**

A router, or multicast-enabled switch, can periodically ask their hosts if they want to receive multicast traffic. If there is more than one router/switch on the LAN performing IP multicasting, one of these devices is elected “**querier**” and assumes the role of querying the LAN for group members. It then propagates the service requests on to any upstream multicast switch/router to ensure that it will continue to receive the multicast service.



Multicast routers use this information, along with a multicast routing protocol such as DVMRP or PIM, to support IP multicasting across the Internet.

4.7.2.1 IGMP Setting

This page provides IGMP Snooping related configuration.

Most of the settings are global, whereas the Router Port configuration is related to the current unit, as reflected by the page header. The IGMP Snooping Setting and Information screens in [Figure 4-7-7](#), [Figure 4-7-8](#) & [Figure 4-7-9](#) appear.

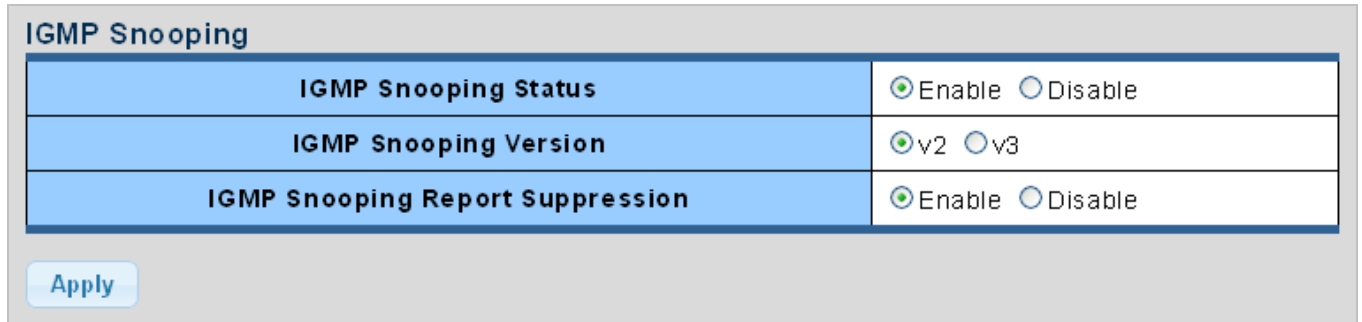

| IGMP Snooping | |
|----------------------------------|---|
| IGMP Snooping Status | <input checked="" type="radio"/> Enable <input type="radio"/> Disable |
| IGMP Snooping Version | <input checked="" type="radio"/> v2 <input type="radio"/> v3 |
| IGMP Snooping Report Suppression | <input checked="" type="radio"/> Enable <input type="radio"/> Disable |

Apply

Figure 4-7-7 IGMP Snooping Page Screenshot

The page includes the following fields:

| Object | Description |
|--|---|
| <ul style="list-style-type: none"> IGMP Snooping Status | Enable or disable the IGMP snooping. The default value is "Disabled". |
| <ul style="list-style-type: none"> IGMP Snooping Version | Sets the IGMP Snooping operation version. Possible versions are: <ul style="list-style-type: none"> ■ v2: Set IGMP Snooping supported IGMP version 2. ■ v3: Set IGMP Snooping supported IGMP version 3. |
| <ul style="list-style-type: none"> IGMP Snooping Report Suppression | Limits the membership report traffic sent to multicast-capable routers. When you disable report suppression, all IGMP reports are sent as is to multicast-capable routers. The default is enabled. |

Buttons

: Click to apply changes.

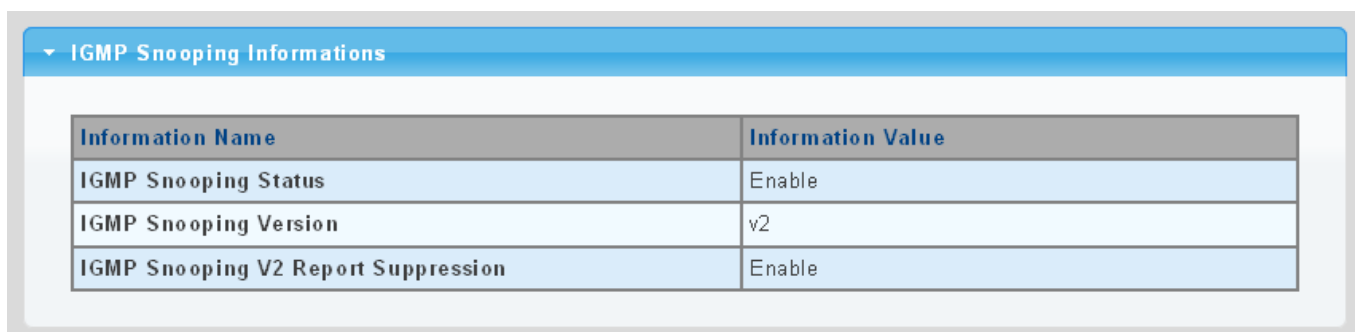

IGMP Snooping Informations

| Information Name | Information Value |
|-------------------------------------|-------------------|
| IGMP Snooping Status | Enable |
| IGMP Snooping Version | v2 |
| IGMP Snooping V2 Report Suppression | Enable |

Figure 4-7-8 IGMP Snooping Information Page Screenshot

The page includes the following fields:

| Object | Description |
|--|--|
| • IGMP Snooping Status | Display the current IGMP snooping status. |
| • IGMP Snooping Version | Display the current IGMP snooping version. |
| • IGMP Snooping V2 Report Suppression | Display the current IGMP snooping v2 report suppression. |

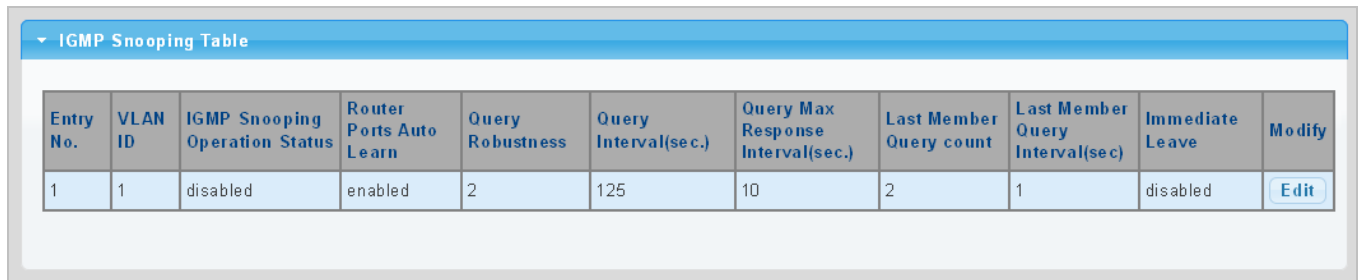

| Entry No. | VLAN ID | IGMP Snooping Operation Status | Router Ports Auto Learn | Query Robustness | Query Interval(sec.) | Query Max Response Interval(sec.) | Last Member Query count | Last Member Query Interval(sec) | Immediate Leave | Modify |
|-----------|---------|--------------------------------|-------------------------|------------------|----------------------|-----------------------------------|-------------------------|---------------------------------|-----------------|----------------------|
| 1 | 1 | disabled | enabled | 2 | 125 | 10 | 2 | 1 | disabled | Edit |

Figure 4-7-9 IGMP Snooping Information Page Screenshot

The page includes the following fields:

| Object | Description |
|---|--|
| • Entry No. | Display the current entry number |
| • VLAN ID | Display the current VLAN ID |
| • IGMP Snooping Operation Status | Display the current IGMP snooping operation status |
| • Router Ports Auto Learn | Display the current router ports auto learning |
| • Query Robustness | Display the current query robustness |
| • Query Interval (sec.) | Display the current query interval |
| • Query Max Response Interval (sec.) | Display the current query max response interval |
| • Last Member Query count | Display the current last member query count |
| • Last Member Query Interval (sec) | Display the current last member query interval |
| • Immediate Leave | Display the current immediate leave |
| • Modify | Click Edit to edit parameter |

4.7.2.2 IGMP Querier Setting

This page provides IGMP Querier Setting. The IGMP Querier Setting screens in [Figure 4-7-10](#) & [Figure 4-7-11](#) appear.

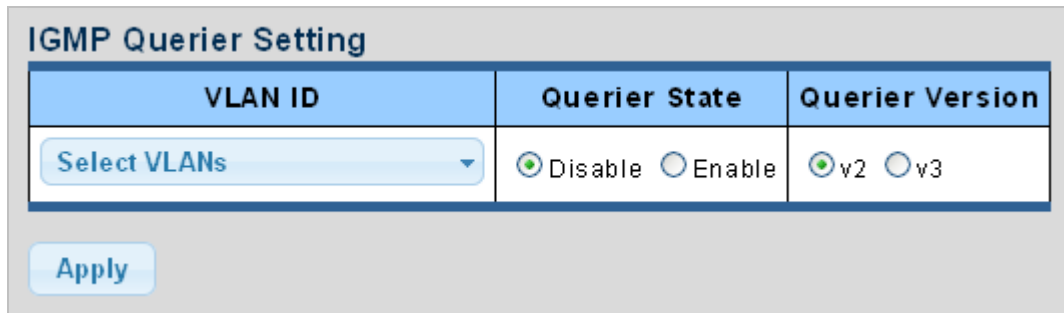

Figure 4-7-10 IGMP VLAN Setting Page Screenshot

The page includes the following fields:

| Object | Description |
|-------------------|---|
| • VLAN ID | Select VLAN ID from this drop-down list. |
| • Querier State | Enable or disable the querier state. The default value is "Disabled". |
| • Querier Version | Sets the querier version for compatibility with other devices on the network. Version: 2 or 3; Default: 2 |

Buttons

: Click to apply changes.

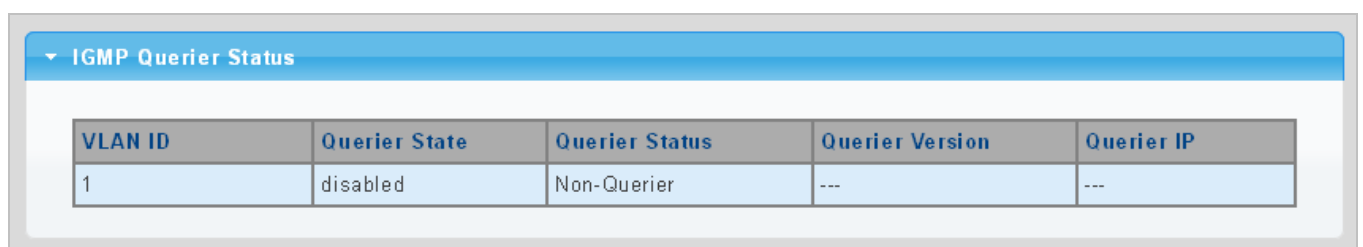

Figure 4-7-11 IGMP Querier Status Page Screenshot

The page includes the following fields:

| Object | Description |
|-------------------|-------------------------------------|
| • VLAN ID | Display the current VLAN ID |
| • Querier State | Display the current querier state |
| • Querier Status | Display the current querier status |
| • Querier Version | Display the current querier version |
| • Querier IP | Display the current querier IP |

4.7.2.3 IGMP Static Group

Multicast filtering can be dynamically configured using IGMP Snooping and IGMP Query messages as described in above sections. For certain applications that require tighter control, you may need to statically configure a multicast service on the LRP Managed Switch. First add all the ports attached to participating hosts to a common VLAN, and then assign the multicast service to that VLAN group.

- Static multicast addresses are never aged out.
- When a multicast address is assigned to an interface in a specific VLAN, the corresponding traffic can only be forwarded to ports within that VLAN.

The IGMP Static Group configuration screens in [Figure 4-7-12](#) & [Figure 4-7-13](#) appear.

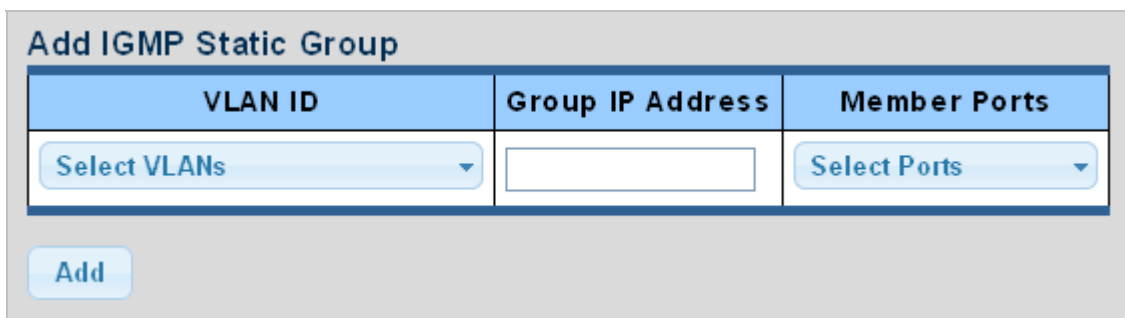

Figure 4-7-12 Add IGMP Static Group Page Screenshot

The page includes the following fields:

| Object | Description |
|---------------------------|---|
| • VLAN ID | Select VLAN ID from this drop-down list |
| • Group IP Address | The IP address for a specific multicast service |
| • Member Ports | Select port number from this drop-down list |

Buttons

: Click to add IGMP router port entry.

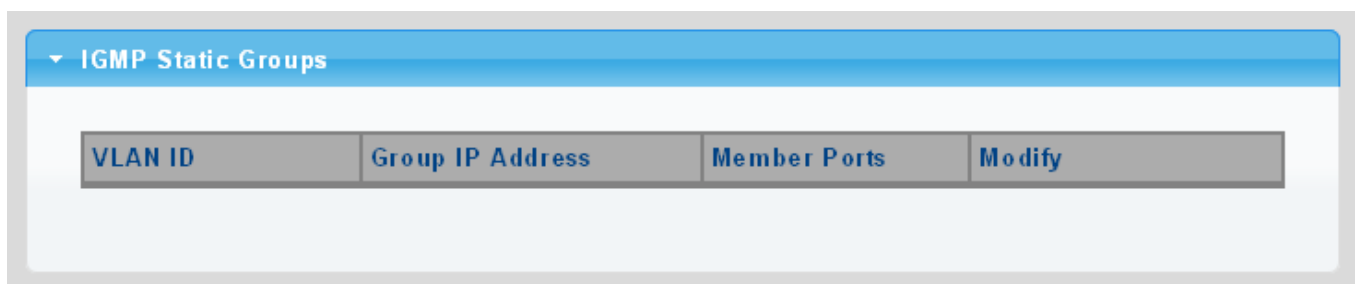



Figure 4-7-13 IGMP Static Groups Page Screenshot

The page includes the following fields:

| Object | Description |
|--------------------|---|
| • VLAN ID | Display the current VLAN ID |
| • Group IP Address | Display the current group IP address |
| • Member Ports | Display the current member ports |
| • Modify | Click  to edit parameter |

4.7.2.4 IGMP Group Table

This page provides Multicast Database. The IGMP Group Table screen in [Figure 4-7-14](#) appears.

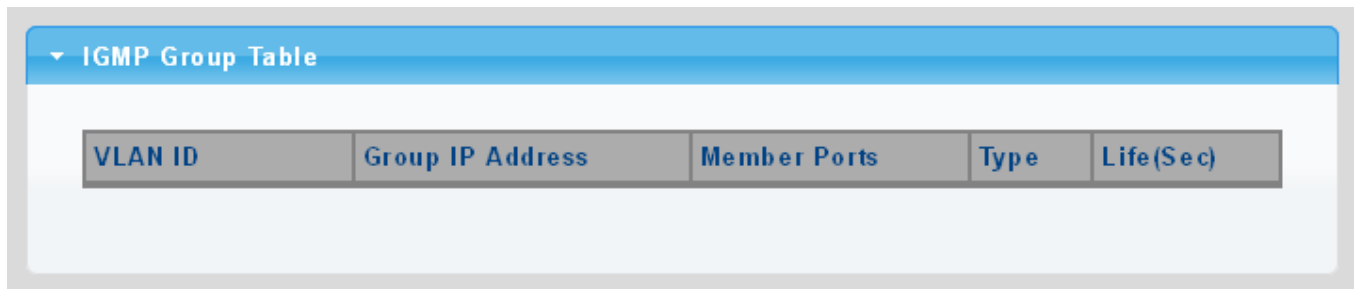

Figure 4-7-14 IGMP Group Table Page Screenshot

The page includes the following fields:

| Object | Description |
|--------------------|---|
| • VLAN ID | Display the current VID |
| • Group IP Address | Display multicast IP address for a specific multicast service |
| • Member Port | Display the current member port |
| • Type | Member types displayed include Static or Dynamic, depending on selected options |
| • Life(Sec) | Display the current life |

4.7.2.5 IGMP Router Setting

Depending on your network connections, IGMP snooping may not always be able to locate the IGMP querier. Therefore, if the IGMP querier is a known multicast router/ switch connected over the network to an interface (port or trunk) on your LRP Managed Switch, you can manually configure the interface (and a specified VLAN) to join all the current multicast groups supported by the attached router. This can ensure that multicast traffic is passed to all the appropriate interfaces within the LRP Managed Switch.

The IGMP Router Setting and Status screens in [Figure 4-7-15](#) & [Figure 4-7-16](#) appear.

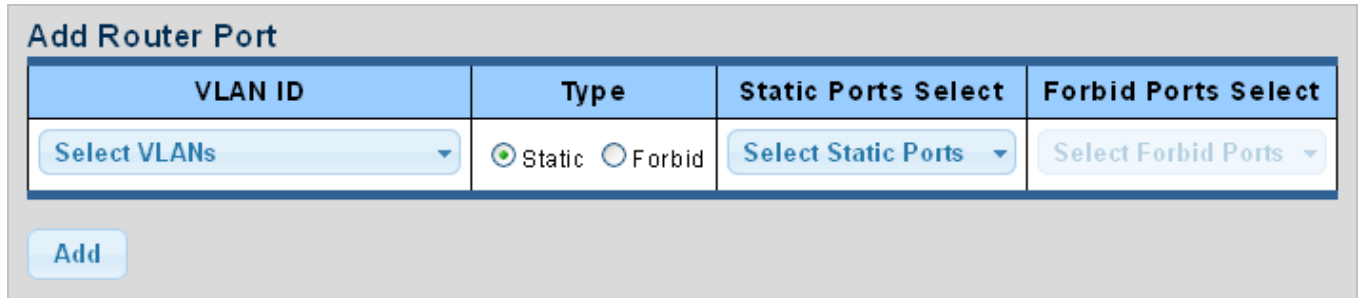

Figure 4-7-15 Add Router Port Page Screenshot

The page includes the following fields:

| Object | Description |
|--|--|
| <ul style="list-style-type: none"> VLAN ID | Selects the VLAN to propagate all multicast traffic coming from the attached multicast router. |
| <ul style="list-style-type: none"> Type | Sets the Router port type. The types of Router port as below: <ul style="list-style-type: none"> ■ Static ■ Forbid |
| <ul style="list-style-type: none"> Static Ports Select | Specify which ports act as router ports. A router port is a port on the Ethernet switch that leads towards the Layer 3 multicast device or IGMP querier. |
| <ul style="list-style-type: none"> Forbid Port Select | Specify which ports un-act as router ports |

Buttons

: Click to add IGMP router port entry.

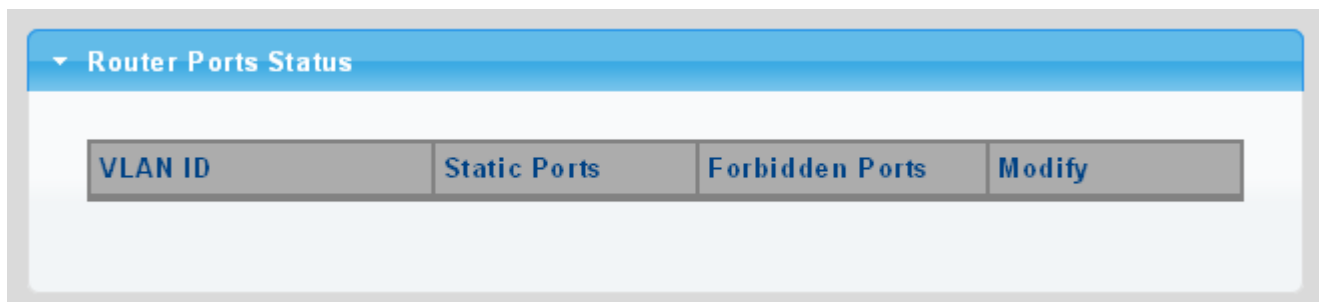



Figure 4-7-16 Router Port Status Page Screenshot

The page includes the following fields:

| Object | Description |
|--|---|
| <ul style="list-style-type: none"> • VLAN ID | Display the current VLAN ID |
| <ul style="list-style-type: none"> • Static Ports | Display the current static ports |
| <ul style="list-style-type: none"> • Forbidden Ports | Display the current forbidden ports |
| <ul style="list-style-type: none"> • Modify | Click  to edit parameter Click  to delete the group ID entry |

4.7.2.6 IGMP Router Table

This page provides Router Table. The Dynamic, Static and Forbidden Router Table screens in [Figure 4-7-17](#), [Figure 4-7-18](#) & [Figure 4-7-19](#) appear.

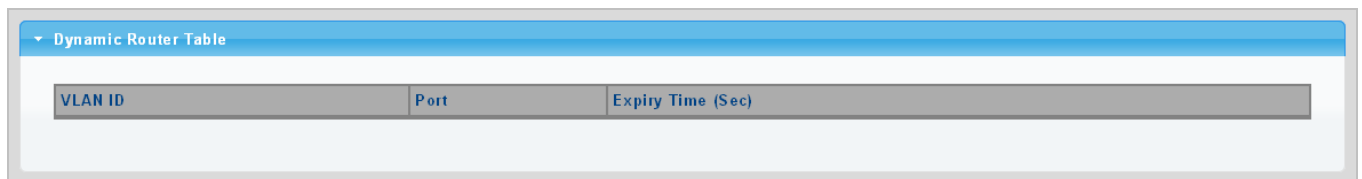

Figure 4-7-17 Dynamic Router Table Page Screenshot

The page includes the following fields:

| Object | Description |
|--|--|
| <ul style="list-style-type: none"> • VLAN ID | Display the current VLAN ID |
| <ul style="list-style-type: none"> • Port | Display the current dynamic router ports |
| <ul style="list-style-type: none"> • Expiry Time (Sec) | Display the current expiry time |

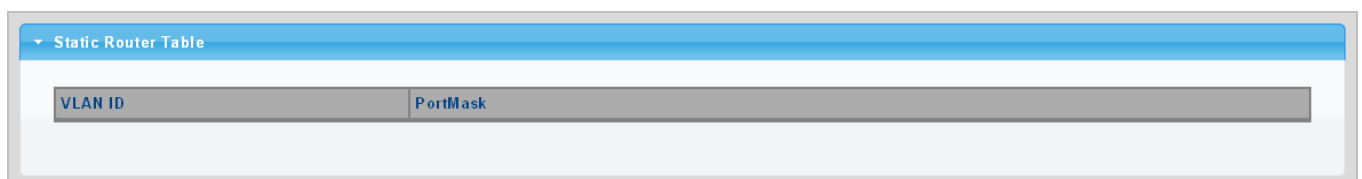

Figure 4-7-18 Static Router Table Page Screenshot

The page includes the following fields:

| Object | Description |
|-------------|-------------------------------|
| • VLAN ID | Display the current VLAN ID |
| • Port Mask | Display the current port mask |

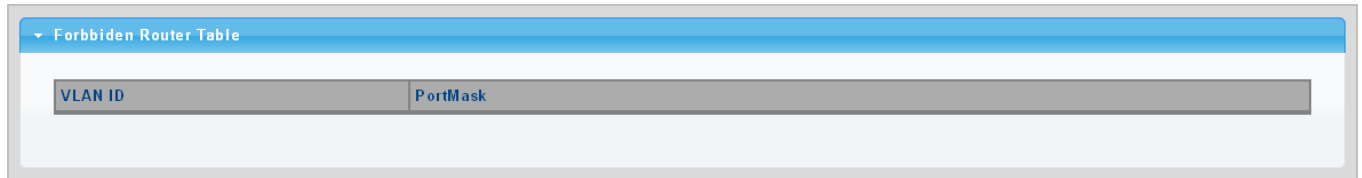

Figure 4-7-19 Forbidden Router Table Page Screenshot

The page includes the following fields:

| Object | Description |
|-------------|-------------------------------|
| • VLAN ID | Display the current VLAN ID |
| • Port Mask | Display the current port mask |

4.7.2.7 IGMP Forward All

This page provides IGMP Forward All. The Forward All screen in [Figure 4-7-20](#) appears.

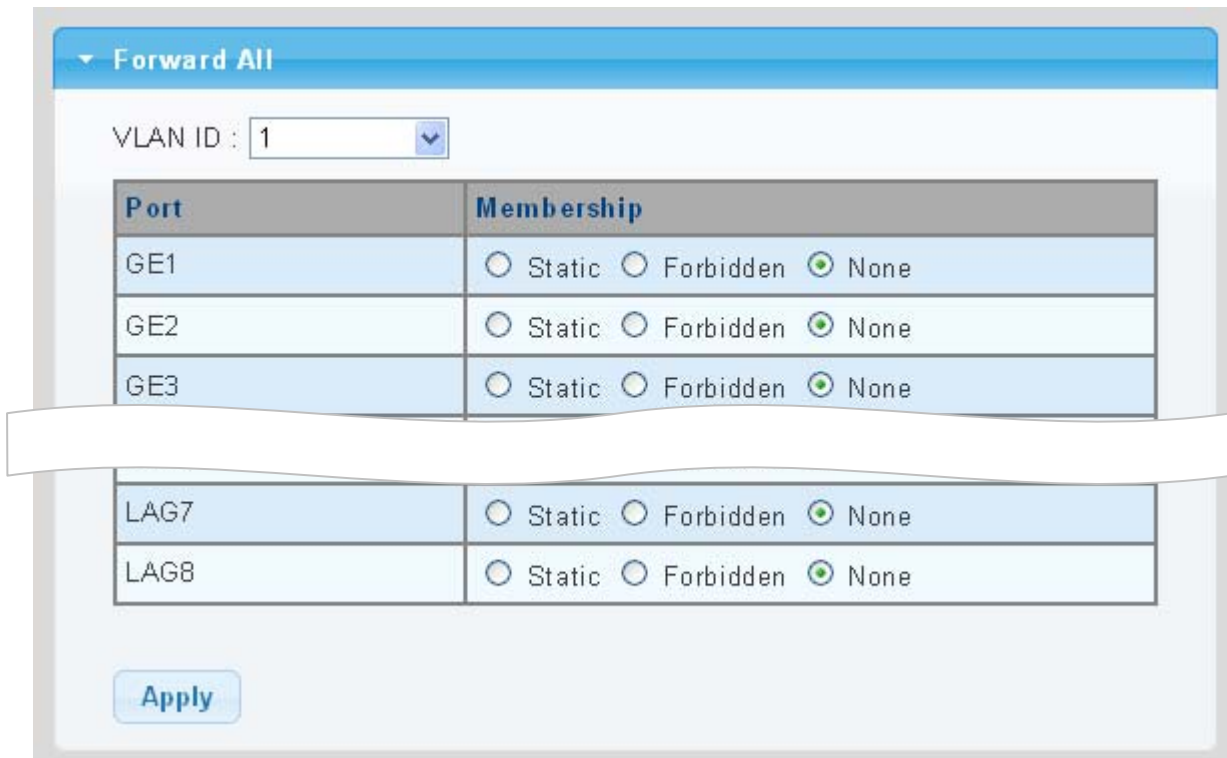

Figure 4-7-20 Forward All Setting Page Screenshot

The page includes the following fields:

| Object | Description | |
|---------------------|---|--|
| • VLAN ID | Select VLAN ID from this drop-down list to assign IGMP membership | |
| • Port | The switch port number of the logical port | |
| • Membership | Select IGMP membership for each interface: | |
| | Forbidden: | Interface is forbidden from automatically joining the IGMP via MVR. |
| | None: | Interface is not a member of the VLAN. Packets associated with this VLAN will not be transmitted by the interface. |
| | Static: | Interface is a member of the IGMP. |

Buttons

: Click to apply changes.

4.7.3 IGMP Snooping Statics

This page provides IGMP Snooping Statics. The IGMP Snooping Statics screen in [Figure 4-7-20](#) appears.

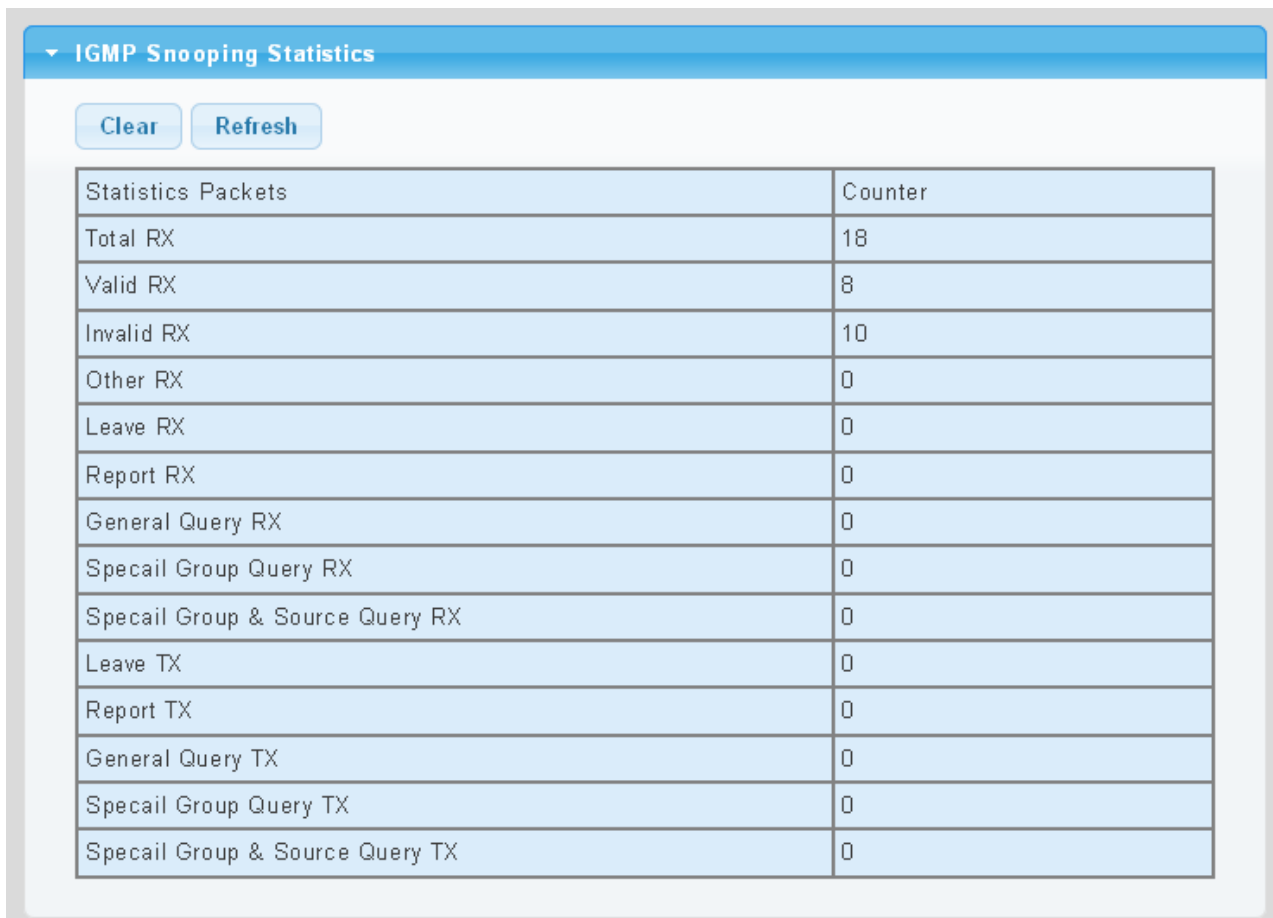

| IGMP Snooping Statistics | |
|---------------------------------|---------|
| Statistics Packets | Counter |
| Total RX | 18 |
| Valid RX | 8 |
| Invalid RX | 10 |
| Other RX | 0 |
| Leave RX | 0 |
| Report RX | 0 |
| General Query RX | 0 |
| Specail Group Query RX | 0 |
| Specail Group & Source Query RX | 0 |
| Leave TX | 0 |
| Report TX | 0 |
| General Query TX | 0 |
| Specail Group Query TX | 0 |
| Specail Group & Source Query TX | 0 |

Figure 4-7-20 Forward All Setting Page Screenshot

The page includes the following fields:

| Object | Description |
|--|---|
| • Total RX | Display current total RX |
| • Valid RX | Display current valid RX |
| • Invalid RX | Display current invalid RX |
| • Other RX | Display current other RX |
| • Leave RX | Display current leave RX |
| • Report RX | Display current report RX |
| • General Query RX | Display current general query RX |
| • Special Group Query RX | Display current special group query RX |
| • Special Group & Source Query RX | Display current special group & source query RX |
| • Leave TX | Display current leave TX |
| • Report TX | Display current report TX |
| • General Query TX | Display current general query TX |
| • Special Group Query TX | Display current special group query TX |
| • Special Group & Source Query TX | Display current special group & source query TX |

Buttons

 : Click to clear the IGMP Snooping Statistics.

 : Click to refresh the IGMP Snooping Statistics.

4.7.4 MLD Snooping

4.7.4.1 MLD Setting

This page provides MLD Snooping related configuration.

Most of the settings are global, whereas the Router Port configuration is related to the current unit, as reflected by the page header. The MLD Snooping Setting, Information and Table screens in [Figure 4-7-21](#), [Figure 4-7-22](#) & [Figure 4-7-23](#) appear.

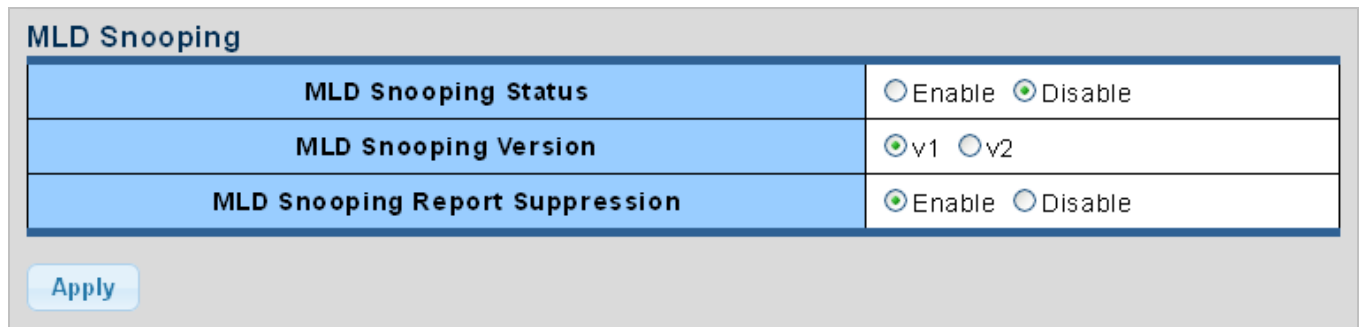

| MLD Snooping | |
|---------------------------------|---|
| MLD Snooping Status | <input type="radio"/> Enable <input checked="" type="radio"/> Disable |
| MLD Snooping Version | <input checked="" type="radio"/> v1 <input type="radio"/> v2 |
| MLD Snooping Report Suppression | <input checked="" type="radio"/> Enable <input type="radio"/> Disable |

Apply

Figure 4-7-21 MLD Snooping Page Screenshot

The page includes the following fields:

| Object | Description |
|---|---|
| <ul style="list-style-type: none"> MLD Snooping Status | Enable or disable the MLD snooping. The default value is "Disabled". |
| <ul style="list-style-type: none"> MLD Snooping Version | Sets the MLD Snooping operation version. Possible versions are: v1 : Set MLD Snooping supported MLD version 1. v2 : Set MLD Snooping supported MLD version 2. |
| <ul style="list-style-type: none"> MLD Snooping Report Suppression | Limits the membership report traffic sent to multicast-capable routers. When you disable report suppression, all MLD reports are sent as is to multicast-capable routers. The default is enabled. |

Buttons

: Click to apply changes.

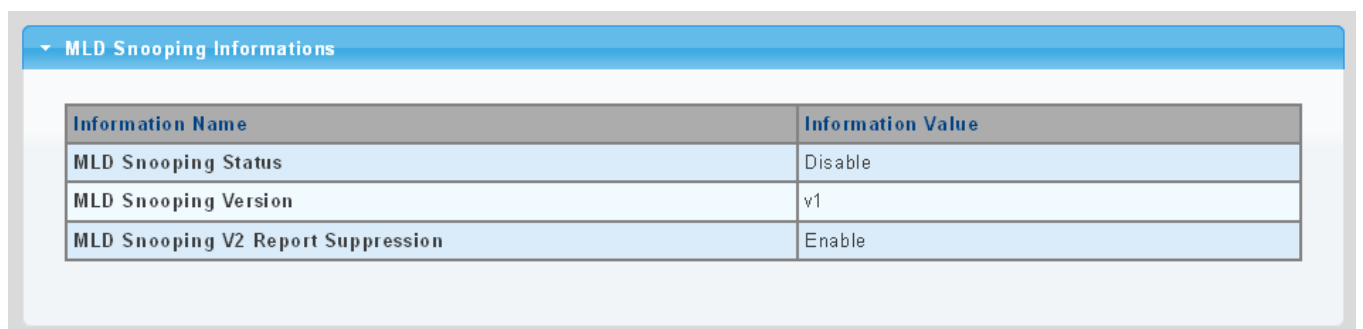

| MLD Snooping Informations | |
|------------------------------------|-------------------|
| Information Name | Information Value |
| MLD Snooping Status | Disable |
| MLD Snooping Version | v1 |
| MLD Snooping V2 Report Suppression | Enable |

Figure 4-7-22 MLD Snooping information Page Screenshot

The page includes the following fields:

| Object | Description |
|--|---|
| • MLD Snooping Status | Display the current MLD snooping status |
| • MLD Snooping Version | Display the current MLD snooping version |
| • MLD Snooping Report Suppression | Display the current MLD snooping report suppression |

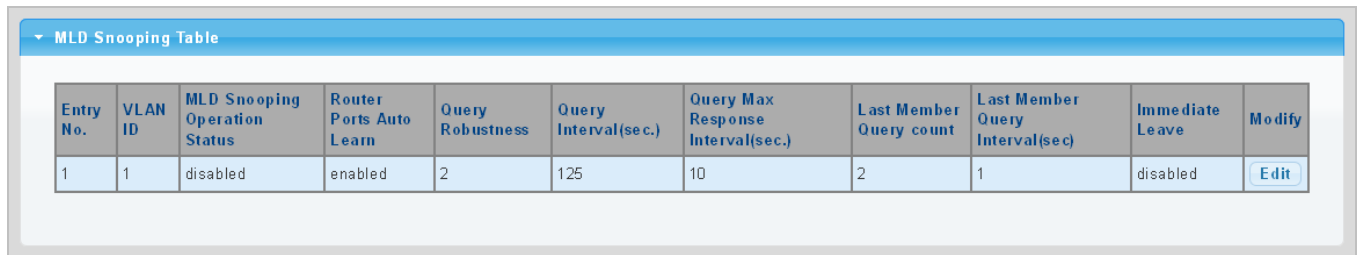

| Entry No. | VLAN ID | MLD Snooping Operation Status | Router Ports Auto Learn | Query Robustness | Query Interval(sec.) | Query Max Response Interval(sec.) | Last Member Query count | Last Member Query Interval(sec) | Immediate Leave | Modify |
|-----------|---------|-------------------------------|-------------------------|------------------|----------------------|-----------------------------------|-------------------------|---------------------------------|-----------------|----------------------|
| 1 | 1 | disabled | enabled | 2 | 125 | 10 | 2 | 1 | disabled | Edit |

Figure 4-7-23 MLD Snooping Table Page Screenshot

The page includes the following fields:

| Object | Description |
|---|---|
| • Entry No. | Display the current entry number |
| • VLAN ID | Display the current VLAN ID |
| • MLD Snooping Operation Status | Display the current MLD snooping operation status |
| • Router Ports Auto Learn | Display the current router ports auto learning |
| • Query Robustness | Display the current query robustness |
| • Query Interval (sec.) | Display the current query interval |
| • Query Max Response Interval (sec.) | Display the current query max response interval |
| • Last Member Query count | Display the current last member query count |
| • Last Member Query Interval (sec) | Display the current last member query interval |
| • Immediate Leave | Display the current immediate leave |
| • Modify | Click Edit to edit parameter |

4.7.4.2 MLD Static Group

The MLD Static Group configuration screens in [Figure 4-7-24](#) & [Figure 4-7-25](#) appear.

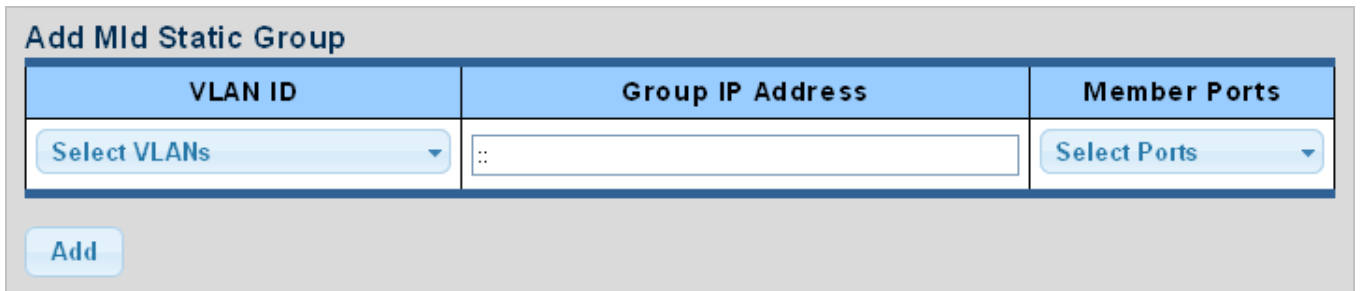

Figure 4-7-24 Add MLD Static Group Page Screenshot

The page includes the following fields:

| Object | Description |
|--------------------|---|
| • VLAN ID | Select VLAN ID from this drop-down list |
| • Group IP Address | The IP address for a specific multicast service |
| • Member Ports | Select port number from this drop-down list |

Buttons

: Click to add IGMP router port entry.

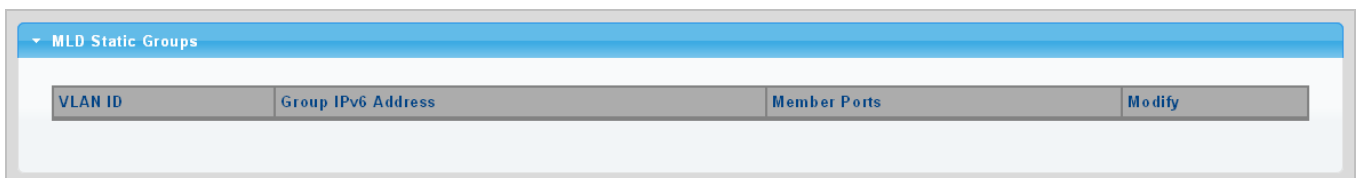



Figure 4-7-25 MLD Static Groups Page Screenshot

The page includes the following fields:

| Object | Description |
|----------------------|--|
| • VLAN ID | Display the current VLAN ID |
| • Group IPv6 Address | Display the current group IPv6 address |
| • Member Ports | Display the current member ports |
| • Modify | Click  to edit parameter. |

4.7.4.3 MLD Group Table

This page provides MLD Group Table. The MLD Group Table screen in [Figure 4-7-26](#) appears.

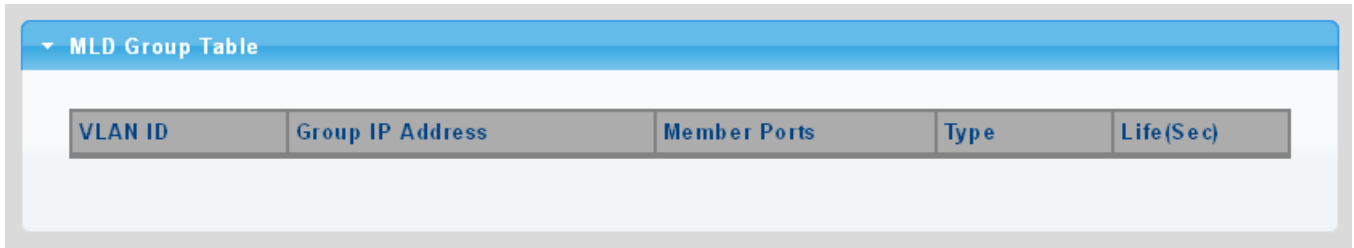

Figure 4-7-26 MLD Group Table Page Screenshot

The page includes the following fields:

| Object | Description |
|--------------------|---|
| • VLAN ID | Display the current VID |
| • Group IP Address | Display multicast IP address for a specific multicast service |
| • Member Port | Display the current member port |
| • Type | Member types displayed include Static or Dynamic, depending on selected options |
| • Life(Sec) | Display the current life |

4.7.4.4 MLD Router Setting

Depending on your network connections, MLD snooping may not always be able to locate the MLD querier. Therefore, if the MLD querier is a known multicast router/ switch connected over the network to an interface (port or trunk) on your LRP Managed Switch, you can manually configure the interface (and a specified VLAN) to join all the current multicast groups supported by the attached router. This can ensure that multicast traffic is passed to all the appropriate interfaces within the LRP Managed Switch.

The MLD Router Setting screens in [Figure 4-7-27](#) & [Figure 4-7-28](#) appear.

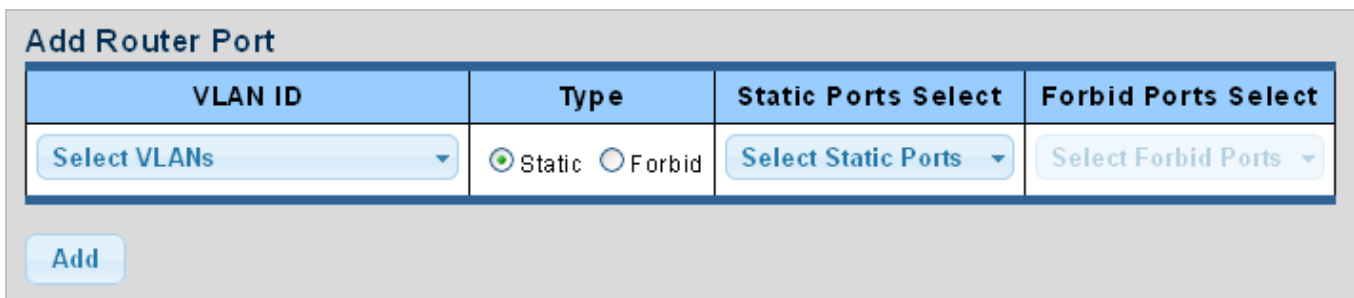



Figure 4-7-27 Add Router Port Page Screenshot

The page includes the following fields:

| Object | Description |
|--|---|
| <ul style="list-style-type: none"> VLAN ID | Selects the VLAN to propagate all multicast traffic coming from the attached multicast router |
| <ul style="list-style-type: none"> Type | Sets the Router port type. The types of Router port as below: Static Forbid |
| <ul style="list-style-type: none"> Static Ports Select | Specify which ports act as router ports. A router port is a port on the Ethernet switch that leads towards the Layer 3 multicast device or MLD querier. |
| <ul style="list-style-type: none"> Forbid Port Select | Specify which ports un-act as router ports |

Buttons

: Click to add MLD router port entry.

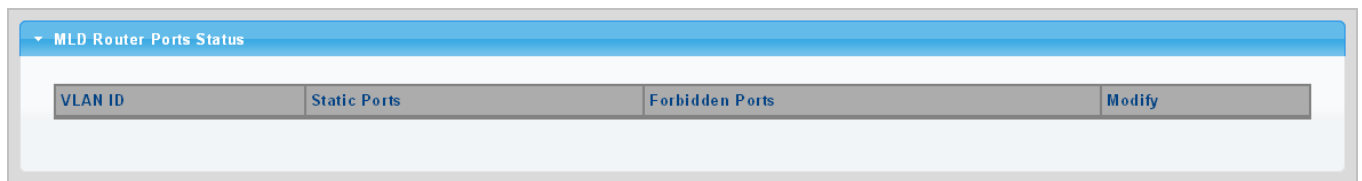



Figure 4-7-28 Router Port Status Page Screenshot

The page includes the following fields:

| Object | Description |
|--|---|
| <ul style="list-style-type: none"> VLAN ID | Display the current VLAN ID |
| <ul style="list-style-type: none"> Static Ports | Display the current static ports |
| <ul style="list-style-type: none"> Forbidden Ports | Display the current forbidden ports |
| <ul style="list-style-type: none"> Modify | Click  to edit parameter Click  to delete the group ID entry |

4.7.4.5 MLD Router Table

This page provides Router Table. The Dynamic, Static and Forbidden Router Table screens in [Figure 4-7-29](#), [Figure 4-7-30](#) & [Figure 4-7-31](#) appear.

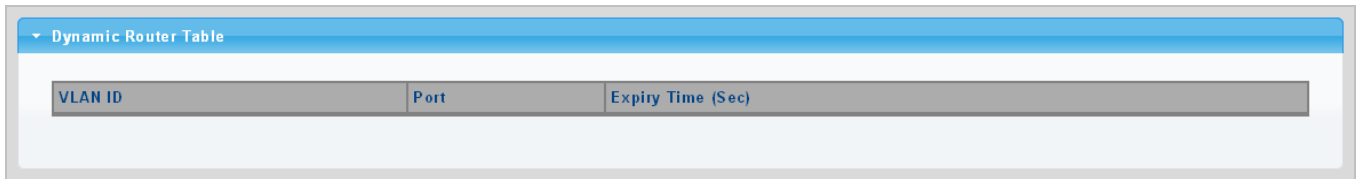

Figure 4-7-29 Dynamic Router Table Page Screenshot

The page includes the following fields:

| Object | Description |
|---------------------|--|
| • VLAN ID | Display the current VLAN ID |
| • Port | Display the current dynamic router ports |
| • Expiry Time (Sec) | Display the current expiry time |

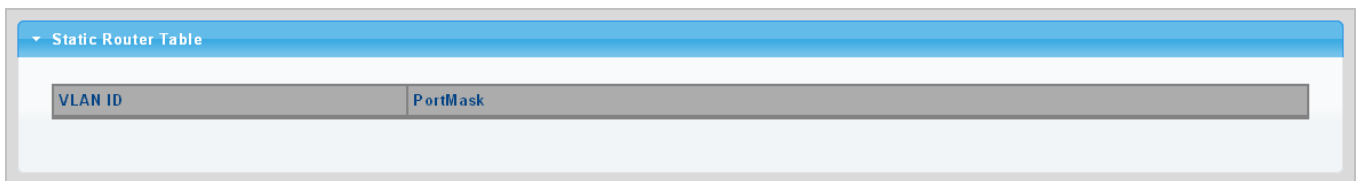

Figure 4-7-30 Static Router Table Page Screenshot

The page includes the following fields:

| Object | Description |
|-------------|-------------------------------|
| • VLAN ID | Display the current VLAN ID |
| • Port Mask | Display the current port mask |

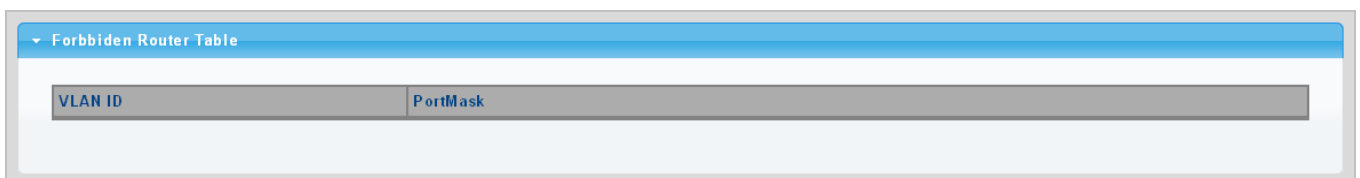

Figure 4-7-31 Forbidden Router Table Page Screenshot

The page includes the following fields:

| Object | Description |
|-------------|-------------------------------|
| • VLAN ID | Display the current VLAN ID |
| • Port Mask | Display the current port mask |

4.7.4.6 MLD Forward All

This page provides MLD Forward All. The Forward All screen in [Figure 4-7-32](#) appears.

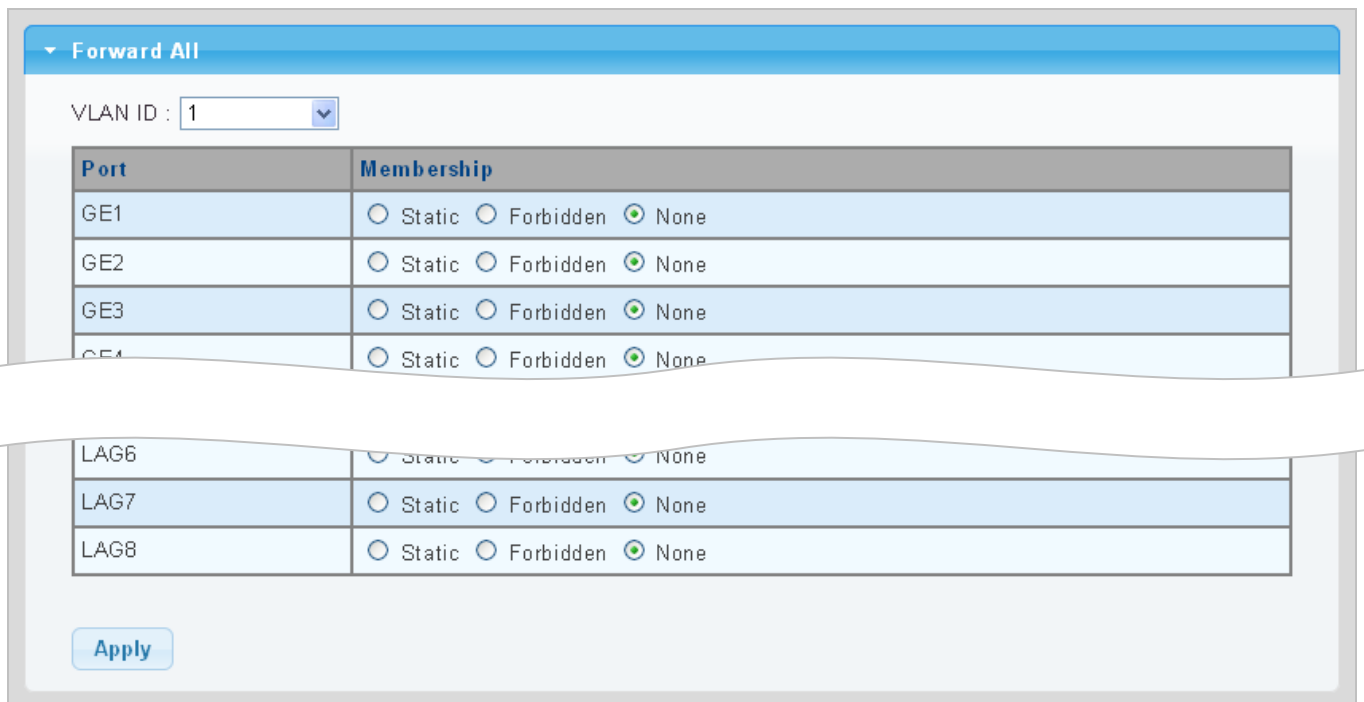



Figure 4-7-32 Forward All Setting Page Screenshot

The page includes the following fields:

| Object | Description |
|--------------|---|
| • VLAN ID | Select VLAN ID from this drop-down list to assign MLD membership |
| • Port | The switch port number of the logical port |
| • Membership | Select MLD membership for each interface: |
| | Forbidden: Interface is forbidden from automatically joining the MLD via MVR. |
| | None: Interface is not a member of the VLAN. Packets associated with this VLAN will not be transmitted by the interface. |
| | Static: Interface is a member of the MLD. |

Buttons

: Click to apply changes.

4.7.5 MLD Snooping Statics

This page provides MLD Snooping Statics. The MLD Snooping Statics screen in [Figure 4-7-33](#) appears.

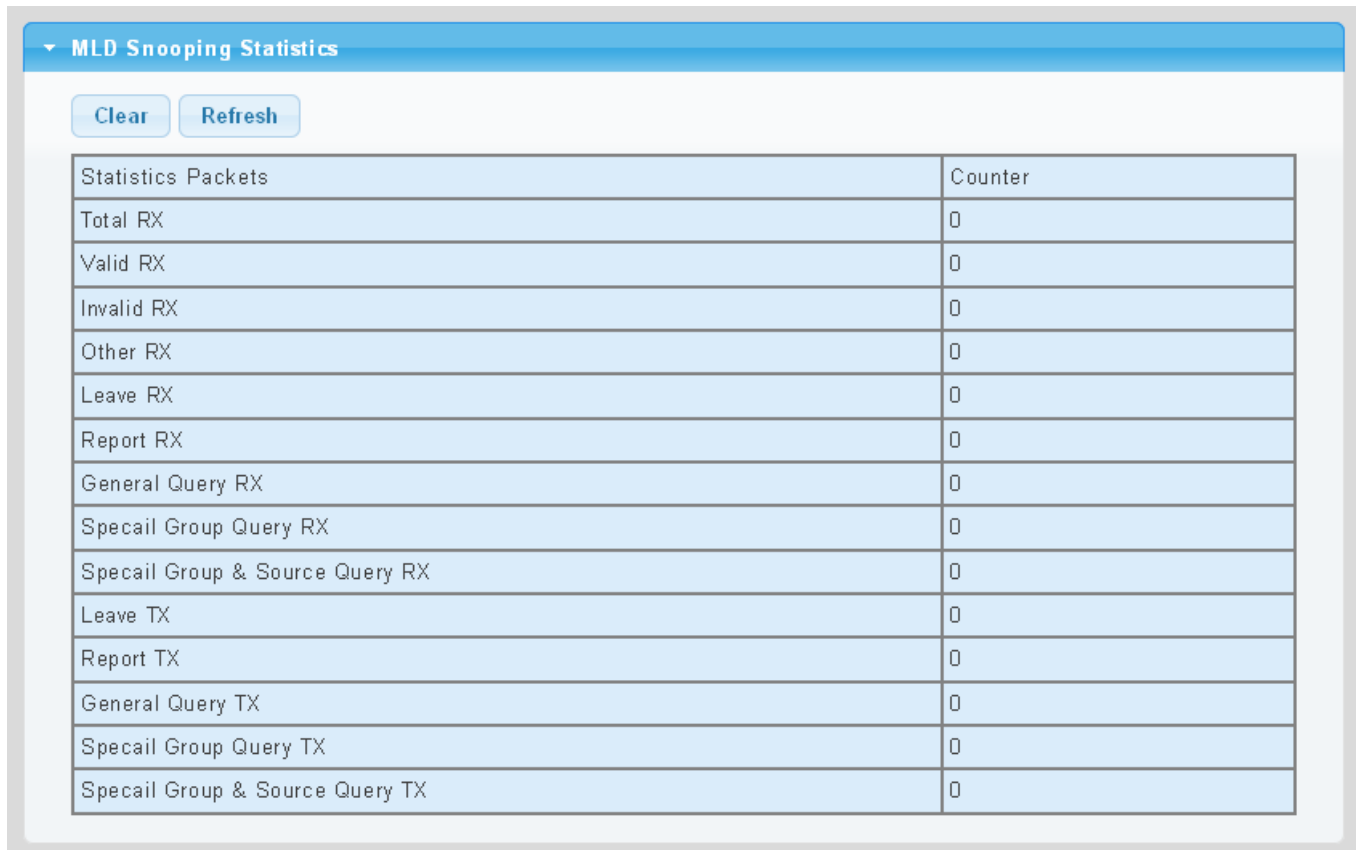

| MLD Snooping Statistics | |
|---|---------|
| <input type="button" value="Clear"/> <input type="button" value="Refresh"/> | |
| Statistics Packets | Counter |
| Total RX | 0 |
| Valid RX | 0 |
| Invalid RX | 0 |
| Other RX | 0 |
| Leave RX | 0 |
| Report RX | 0 |
| General Query RX | 0 |
| Specail Group Query RX | 0 |
| Specail Group & Source Query RX | 0 |
| Leave TX | 0 |
| Report TX | 0 |
| General Query TX | 0 |
| Specail Group Query TX | 0 |
| Specail Group & Source Query TX | 0 |

Figure 4-7-33 Forward All Setting Page Screenshot

The page includes the following fields:

| Object | Description |
|------------------------------|--|
| • Total RX | Display the current total RX |
| • Valid RX | Display the current valid RX |
| • Invalid RX | Display the current invalid RX |
| • Other RX | Display the current other RX |
| • Leave RX | Display the current leave RX |
| • Report RX | Display the current report RX |
| • General Query RX | Display the current general query RX |
| • Special Group Query | Display the current special group query RX |

| | |
|--|---|
| RX | |
| • Special Group & Source Query RX | Display the current special group & source query RX |
| • Leave TX | Display the current leave TX |
| • Report TX | Display the current report TX |
| • General Query TX | Display the current general query TX |
| • Special Group Query TX | Display the current special group query TX |
| • Special Group & Source Query TX | Display the current special group & source query TX |

Buttons



: Click to clear the MLD Snooping Statistics.



: Click to refresh the MLD Snooping Statistics.

4.7.6 Multicast Throttling Setting

Multicast throttling sets a maximum number of multicast groups that a port can join at the same time. When the maximum number of groups is reached on a port, the switch can take one of two actions; either “deny” or “replace”. If the action is set to deny, any new multicast join reports will be dropped. If the action is set to replace, the switch randomly removes an existing group and replaces it with the new multicast group.

Once you have configured multicast profiles, you can assign them to interfaces on the LRP Managed Switch. Also you can set the multicast throttling number to limit the number of multicast groups an interface can join at the same time. The MAX Group and Information screens in [Figure 4-7-34](#) & [Figure 4-7-35](#) appear.

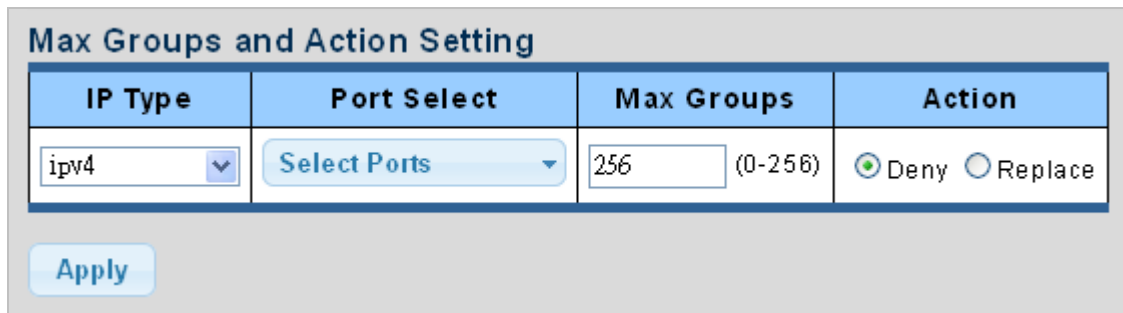

| IP Type | Port Select | Max Groups | Action |
|---------|--------------|-------------|---|
| ipv4 | Select Ports | 256 (0-256) | <input checked="" type="radio"/> Deny <input type="radio"/> Replace |

Apply

Figure 4-7-34 Max Groups and Action Setting Page Screenshot

The page includes the following fields:

| Object | Description |
|---------------|--|
| • IP Type | Select IPv4 or IPv6 from this drop-down list |
| • Port Select | Select port number from this drop-down list |
| • Max Groups | Sets the maximum number of multicast groups an interface can join at the same time. Range: 0-256; Default: 256 |
| • Action | Sets the action to take when the maximum number of multicast groups for the interface has been exceeded. (Default: Deny) -Deny - The new multicast group join report is dropped -Replace - The new multicast group replaces an existing group |

Buttons

: Click to apply changes.

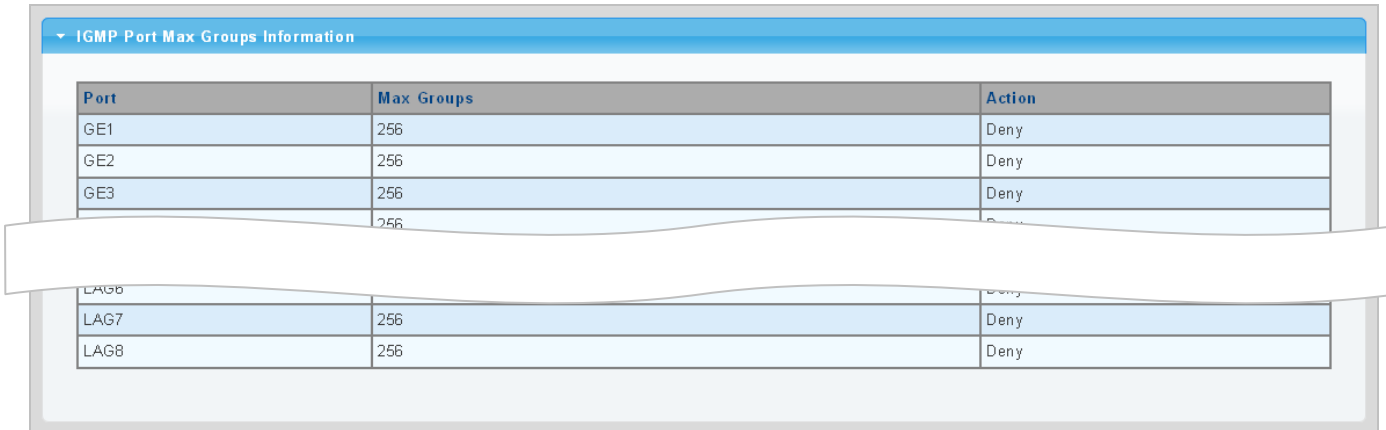

| Port | Max Groups | Action |
|------|------------|--------|
| GE1 | 256 | Deny |
| GE2 | 256 | Deny |
| GE3 | 256 | Deny |
| LAG6 | 256 | Deny |
| LAG7 | 256 | Deny |
| LAG8 | 256 | Deny |

Figure 4-7-35 IGMP Port Max Groups Information Page Screenshot

The page includes the following fields:

| Object | Description |
|---|--|
| <ul style="list-style-type: none"> • Port | The switch port number of the logical port |
| <ul style="list-style-type: none"> • Max Groups | Display the current Max groups |
| <ul style="list-style-type: none"> • Action | Display the current action |

4.7.7 Multicast Filter

In certain switch applications, the administrator may want to control the multicast services that are available to end users. For example, an IP/TV service is based on a specific subscription plan. The multicast filtering feature fulfills this requirement by restricting access to specified multicast services on a switch port.

Multicast filtering enables you to assign a profile to a switch port that specifies multicast groups that are permitted or denied on the port. A multicast filter profile can contain one or more, or a range of multicast addresses; but only one profile can be assigned to a port. When enabled, multicast join reports received on the port are checked against the filter profile. If a requested multicast group is permitted, the multicast join report is forwarded as normal. If a requested multicast group is denied, the multicast join report is dropped.

When you have created a Multicast profile number, you can then configure the multicast groups to filter and set the access mode.

Command Usage

- Each profile has only one access mode; either **permit** or **deny**.
- When the access mode is set to **permit**, multicast join reports are processed when a multicast group falls within the controlled range.
- When the access mode is set to **deny**, multicast join reports are only processed when the multicast group is not in the controlled range.

4.7.7.1 Multicast Profile Setting

The Add Profile and Profile Status screens in [Figure 4-7-36](#) & [Figure 4-7-37](#) appear.

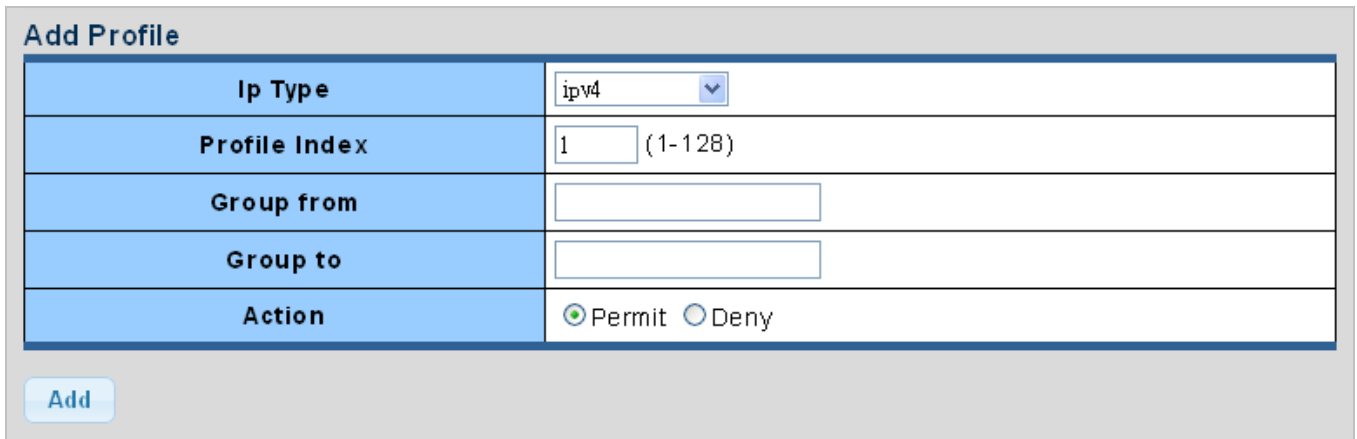

| Add Profile | |
|---------------|--|
| Ip Type | ipv4 |
| Profile Index | 1 (1-128) |
| Group from | |
| Group to | |
| Action | <input checked="" type="radio"/> Permit <input type="radio"/> Deny |

Add

Figure 4-7-36 Add Profile Setting Page Screenshot

The page includes the following fields:

| Object | Description | |
|-----------------|---|--|
| • IP Type | Select IPv4 or IPv6 from this drop-down list | |
| • Profile Index | Indicates the ID of this particular profile | |
| • Group from | Specifies multicast groups to include in the profile. Specify a multicast group range by entering a start IP address. | |
| • Group to | Specifies multicast groups to include in the profile. Specify a multicast group range by entering an end IP address. | |
| • Action | Sets the access mode of the profile; either permit or deny . | |
| | - Permit | Multicast join reports are processed when a multicast group falls within the controlled range. |
| | - Deny | When the access mode is set to, multicast join reports are only processed when the multicast group is not in the controlled range. |

Buttons

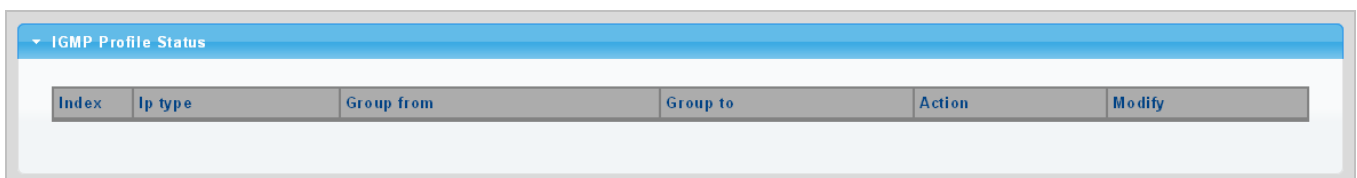

: Click to add multicast profile entry.



| IGMP Profile Status | | | | | |
|---------------------|---------|------------|----------|--------|--------|
| Index | Ip type | Group from | Group to | Action | Modify |

Figure 4-7-37 IGMP/MLD Profile Status Page Screenshot

The page includes the following fields:

| Object | Description |
|--------------|---|
| • Index | Display the current index |
| • IP Type | Display the current IP Type |
| • Group from | Display the current group from |
| • Group to | Display the current group to |
| • Action | Display the current action |
| • Modify | Click  to edit parameter. Click  to delete the MLD/IGMP profile entry. |

4.7.7.2 IGMP Filter Setting

The Filter Setting and Status screens in [Figure 4-7-38](#) & [Figure 4-7-39](#) appear.

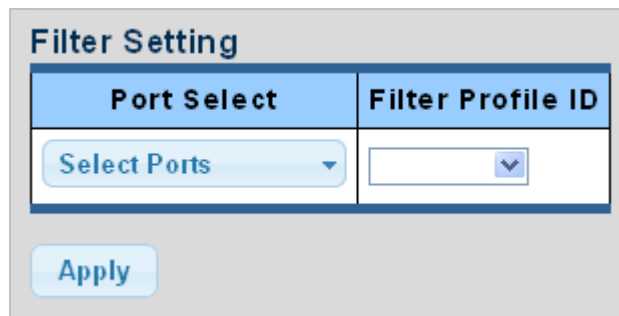

Figure 4-7-38 Filter Setting Page Screenshot

The page includes the following fields:

| Object | Description |
|---------------------|---|
| • Port Select | Select port number from this drop-down list |
| • Filter Profile ID | Select filter profile ID from this drop-down list |

Buttons

: Click to apply changes.

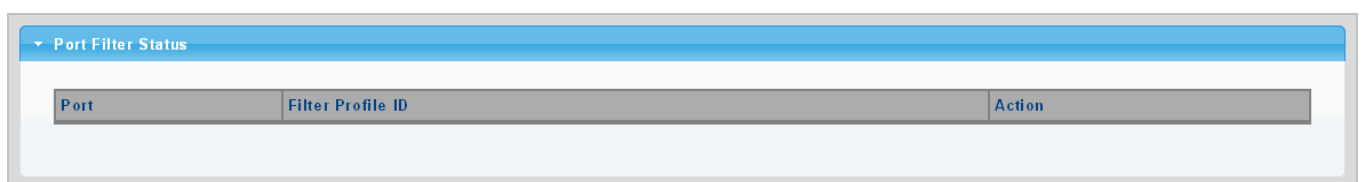



Figure 4-7-39 Port Filter Status Page Screenshot

The page includes the following fields:

| Object | Description |
|---------------------|--|
| • Port | Display the current port |
| • Filter Profile ID | Display the current filter profile ID |
| • Action | Click  to display detail profile parameter Click  to delete the IGMP filter profile entry |

4.7.7.3 MLD Filter Setting

The Filter Setting and Status screens in [Figure 4-7-40](#) & [Figure 4-7-41](#) appear.

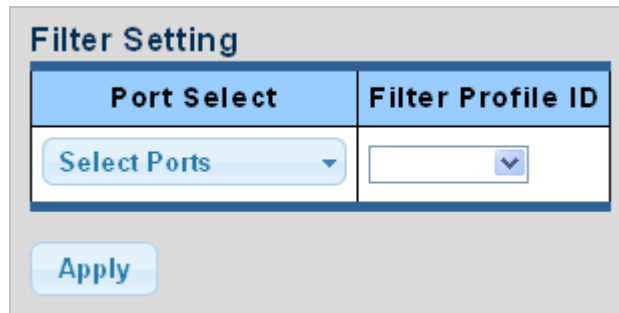

Figure 4-7-40 Filter Setting Page Screenshot

The page includes the following fields:

| Object | Description |
|---------------------|---|
| • Port Select | Select port number from this drop-down list |
| • Filter Profile ID | Select filter profile ID from this drop-down list |

Buttons

: Click to apply changes.

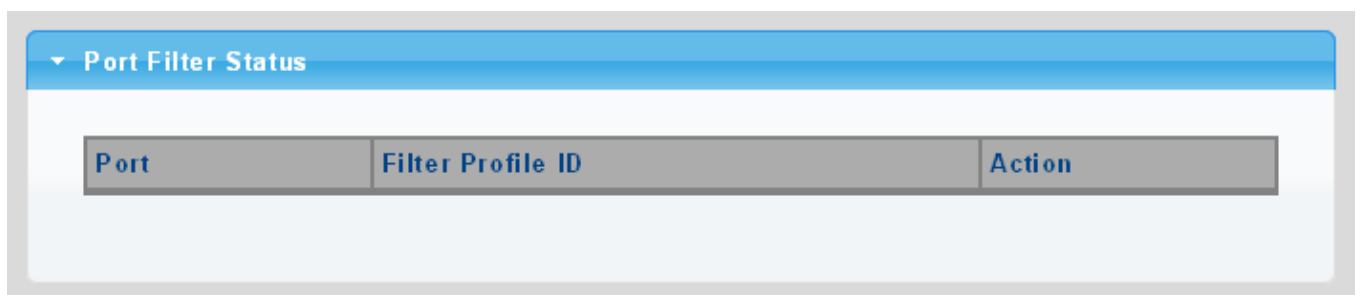



Figure 4-7-41 Port Filter Status Page Screenshot

The page includes the following fields:

| Object | Description |
|---------------------|---|
| • Port | Display the current port |
| • Filter Profile ID | Display the current filter profile ID |
| • Action | Click  to display detail profile parameter Click  to delete the MLD filter profile entry |

4.8 Quality of Service

4.8.1 Understand QoS

Quality of Service (QoS) is an advanced traffic prioritization feature that allows you to establish control over network traffic. QoS enables you to assign various grades of network service to different types of traffic, such as multi-media, video, protocol-specific, time critical, and file-backup traffic.

QoS reduces bandwidth limitations, delay, loss, and jitter. It also provides increased reliability for delivery of your data and allows you to prioritize certain applications across your network. You can define exactly how you want the switch to treat selected applications and types of traffic.

You can use QoS on your system to:

- Control a wide variety of network traffic by:
- Classifying traffic based on packet attributes.
- Assigning priorities to traffic (for example, to set higher priorities to time-critical or business-critical applications).
- Applying security policy through traffic filtering.
- Provide predictable throughput for multimedia applications such as video conferencing or voice over IP by minimizing delay and jitter.
- Improve performance for specific types of traffic and preserve performance as the amount of traffic grows.
- Reduce the need to constantly add bandwidth to the network.
- Manage network congestion.

To implement QoS on your network, you need to carry out the following actions:

1. Define a service level to determine the priority that will be applied to traffic.
2. Apply a classifier to determine how the incoming traffic will be classified and thus treated by the Switch.
3. Create a QoS profile which associates a service level and a classifier.
4. Apply a QoS profile to a port(s).

The **QoS** page of the LRP Managed Switch contains three types of QoS mode - the **802.1p** mode, **DSCP** mode or **Port-base** mode can be selected. Both the three mode rely on predefined fields within the packet to determine the output queue.

- **802.1p Tag Priority Mode** –The output queue assignment is determined by the IEEE 802.1p VLAN priority tag.
- **IP DSCP Mode** - The output queue assignment is determined by the TOS or DSCP field in the IP packets.
- **Port-Base Priority Mode** – Any packet received from the specify high priority port will treated as a high priority packet.

The LRP Managed Switch supports **eight priority level** queue, the queue service rate is based on the **WRR(Weight Round Robin)** and **WFQ (Weighted Fair Queuing)** alorithm. The WRR ratio of high-priority and low-priority can be set to “**4:1** and **8:1**.”

4.8.2 General

4.8.2.1 QoS Properties

The QoS Global Setting and Information screen in [Figure 4-8-1](#) & [Figure 4-8-2](#) appear.

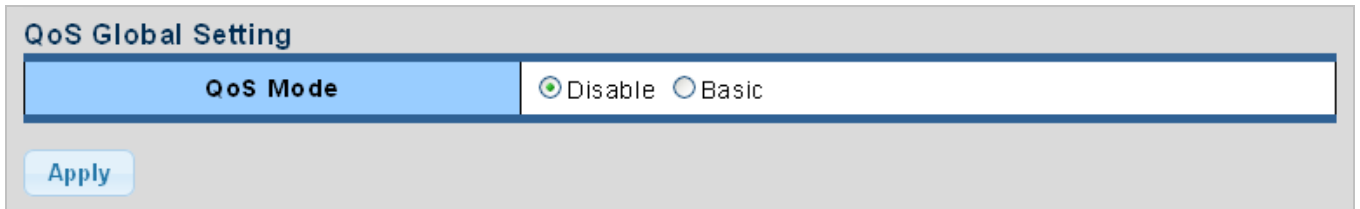

Figure 4-8-1 QoS Global Setting Page Screenshot

The page includes the following fields:

| Object | Description |
|------------|----------------------------|
| • QoS Mode | Enable or disable QoS mode |

Buttons



: Click to apply changes.

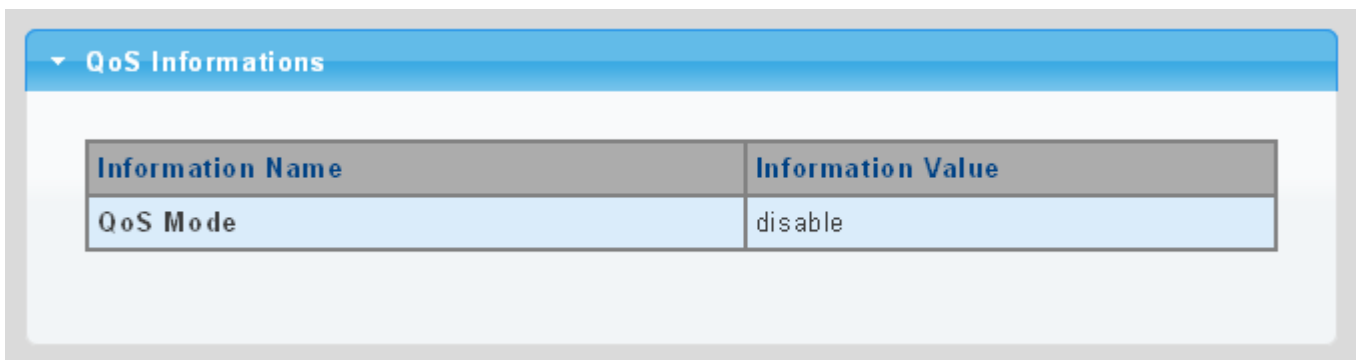

Figure 4-8-2 QoS Information Page Screenshot

The page includes the following fields:

| Object | Description |
|------------|------------------------------|
| • QoS Mode | Display the current QoS mode |

4.8.2.2 QoS Port Settings

The QoS Port Settings and Status screens in [Figure 4-8-2](#) & [Figure 4-8-3](#) appear.

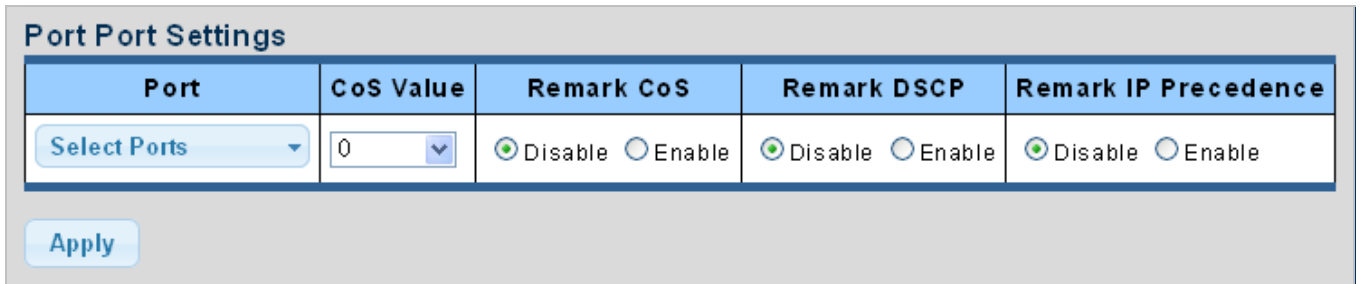

| Port | CoS Value | Remark CoS | Remark DSCP | Remark IP Precedence |
|--------------|-----------|---|---|---|
| Select Ports | 0 | <input checked="" type="radio"/> Disable <input type="radio"/> Enable | <input checked="" type="radio"/> Disable <input type="radio"/> Enable | <input checked="" type="radio"/> Disable <input type="radio"/> Enable |

Apply

Figure 4-8-2 QoS Port Setting Page Screenshot

The page includes the following fields:

| Object | Description |
|------------------------|---|
| • Port Select | Select port number from this drop-down list |
| • CoS Value | Select CoS value from this drop-down list |
| • Remark CoS | Disable or enable remark CoS |
| • Remark DSCP | Disable or enable remark DSCP |
| • Remark IP Precedence | Disable or enable remark IP Precedence |

Buttons

: Click to apply changes.

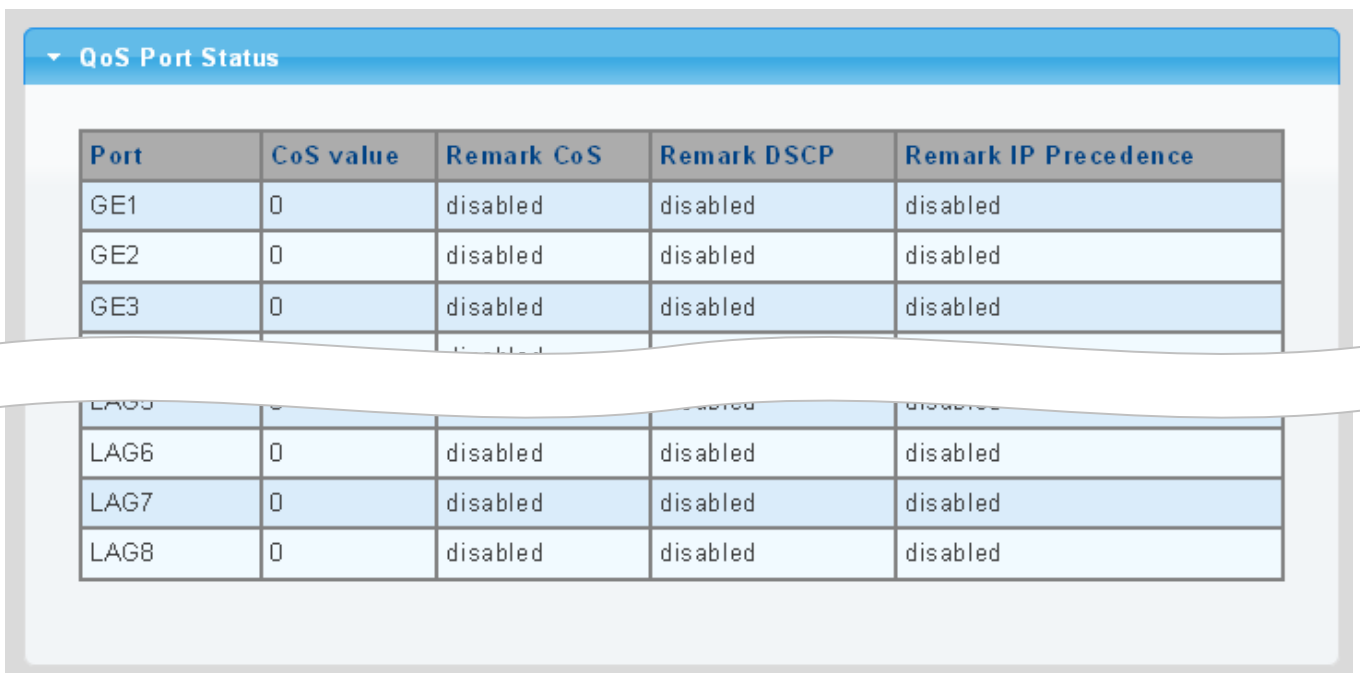

| Port | CoS value | Remark CoS | Remark DSCP | Remark IP Precedence |
|------|-----------|------------|-------------|----------------------|
| GE1 | 0 | disabled | disabled | disabled |
| GE2 | 0 | disabled | disabled | disabled |
| GE3 | 0 | disabled | disabled | disabled |
| LAG5 | 0 | disabled | disabled | disabled |
| LAG6 | 0 | disabled | disabled | disabled |
| LAG7 | 0 | disabled | disabled | disabled |
| LAG8 | 0 | disabled | disabled | disabled |

Figure 4-8-3 QoS Port Status Page Screenshot

The page includes the following fields:

| Object | Description |
|------------------------|--|
| • Port | The switch port number of the logical port |
| • CoS Value | Display the current CoS value |
| • Remark CoS | Display the current remark CoS |
| • Remark DSCP | Display the current remark DSCP |
| • Remark IP Precedence | Display the current remark IP precedence |

4.8.2.3 Queue Settings

The Queue Table and Information screens in [Figure 4-8-4](#) & [Figure 4-8-5](#) appear.

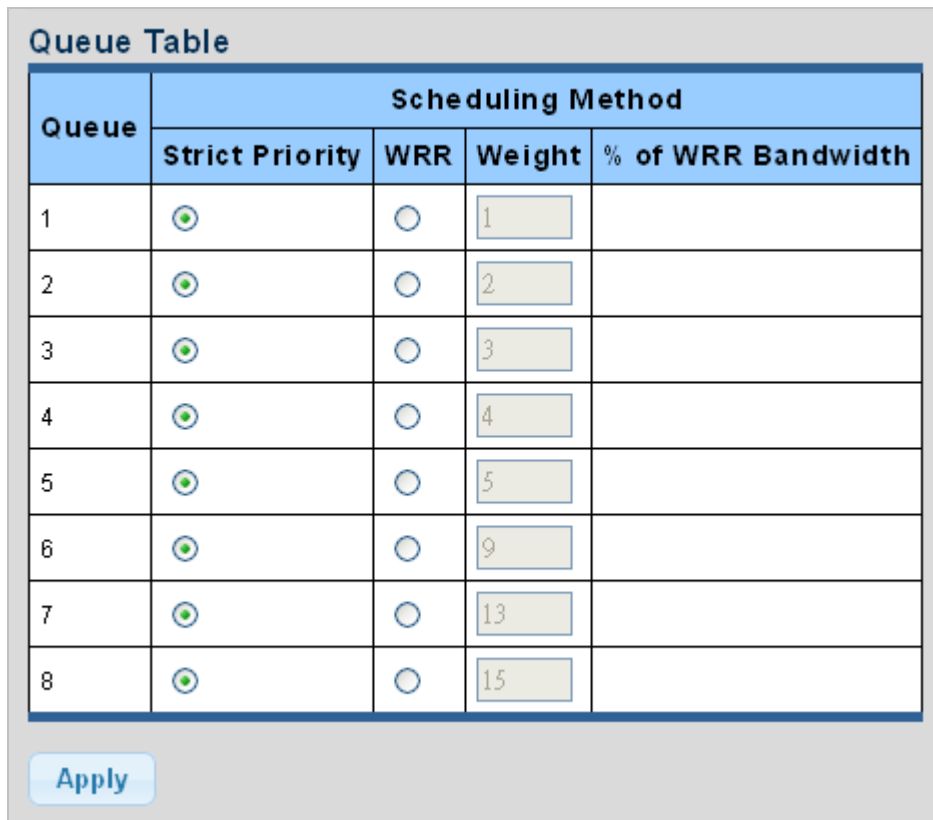

| Queue | Scheduling Method | | | |
|-------|----------------------------------|-----------------------|--------|--------------------|
| | Strict Priority | WRR | Weight | % of WRR Bandwidth |
| 1 | <input checked="" type="radio"/> | <input type="radio"/> | 1 | |
| 2 | <input checked="" type="radio"/> | <input type="radio"/> | 2 | |
| 3 | <input checked="" type="radio"/> | <input type="radio"/> | 3 | |
| 4 | <input checked="" type="radio"/> | <input type="radio"/> | 4 | |
| 5 | <input checked="" type="radio"/> | <input type="radio"/> | 5 | |
| 6 | <input checked="" type="radio"/> | <input type="radio"/> | 9 | |
| 7 | <input checked="" type="radio"/> | <input type="radio"/> | 13 | |
| 8 | <input checked="" type="radio"/> | <input type="radio"/> | 15 | |

Figure 4-8-4 Queue Table Page Screenshot

The page includes the following fields:

| Object | Description |
|-------------------|--|
| • Queue | Display the current queue ID |
| • Strict Priority | Controls whether the scheduler mode is "Strict Priority" on this switch port |

| | |
|-----------------------------|---|
| • WRR | Controls whether the scheduler mode is "Weighted" on this switch port |
| • Weight | Controls the weight for this queue. This value is restricted to 1-100. This parameter is only shown if "Scheduler Mode" is set to "Weighted". |
| • % of WRR Bandwidth | Display the current bandwidth for each queue |

Buttons

: Click to apply changes.

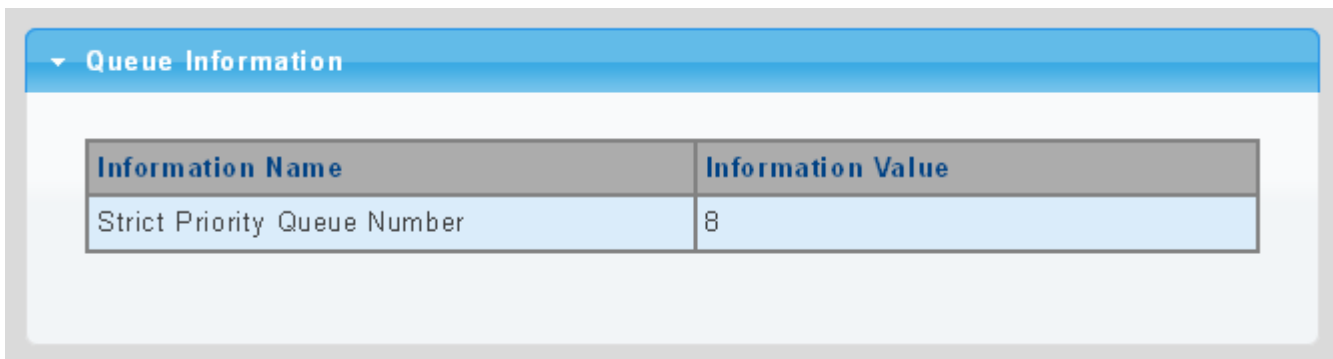

Figure 4-8-5 Queue Information Page Screenshot

The page includes the following fields:

| Object | Description |
|----------------------------|--|
| • Information Name | Display the current queue method information |
| • Information Value | Display the current queue value information |

4.8.2.4 CoS Mapping

The CoS to Queue and Queue to CoS Mapping screens in [Figure 4-8-6](#) & [Figure 4-8-7](#) appear.

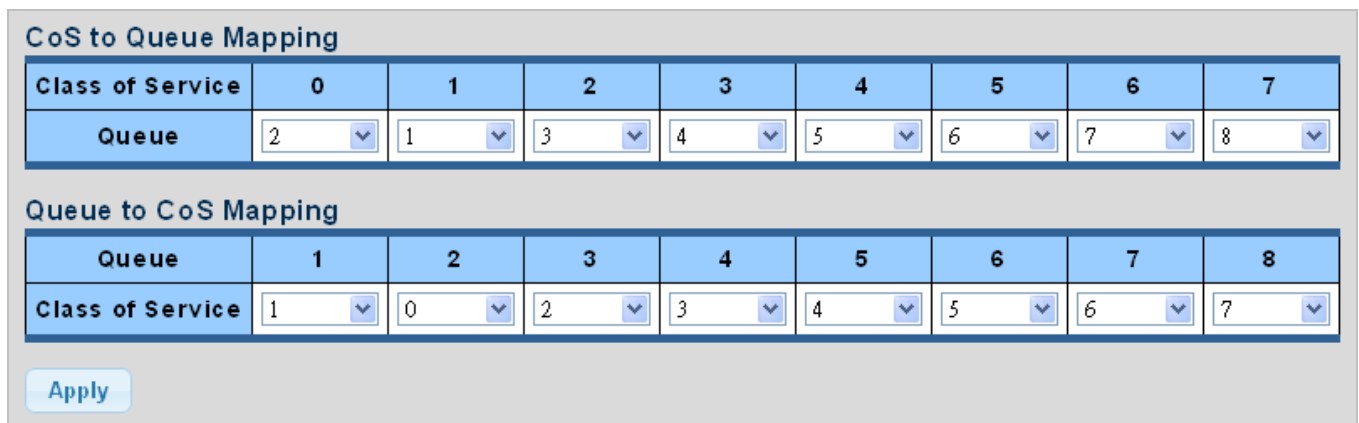



Figure 4-8-6 CoS to Queue and Queue to CoS Mapping Page Screenshot

The page includes the following fields:

| Object | Description |
|--------------------|---|
| • Queue | Select Queue value from this drop-down list |
| • Class of Service | Select CoS value from this drop-down list |

Buttons

: Click to apply changes.

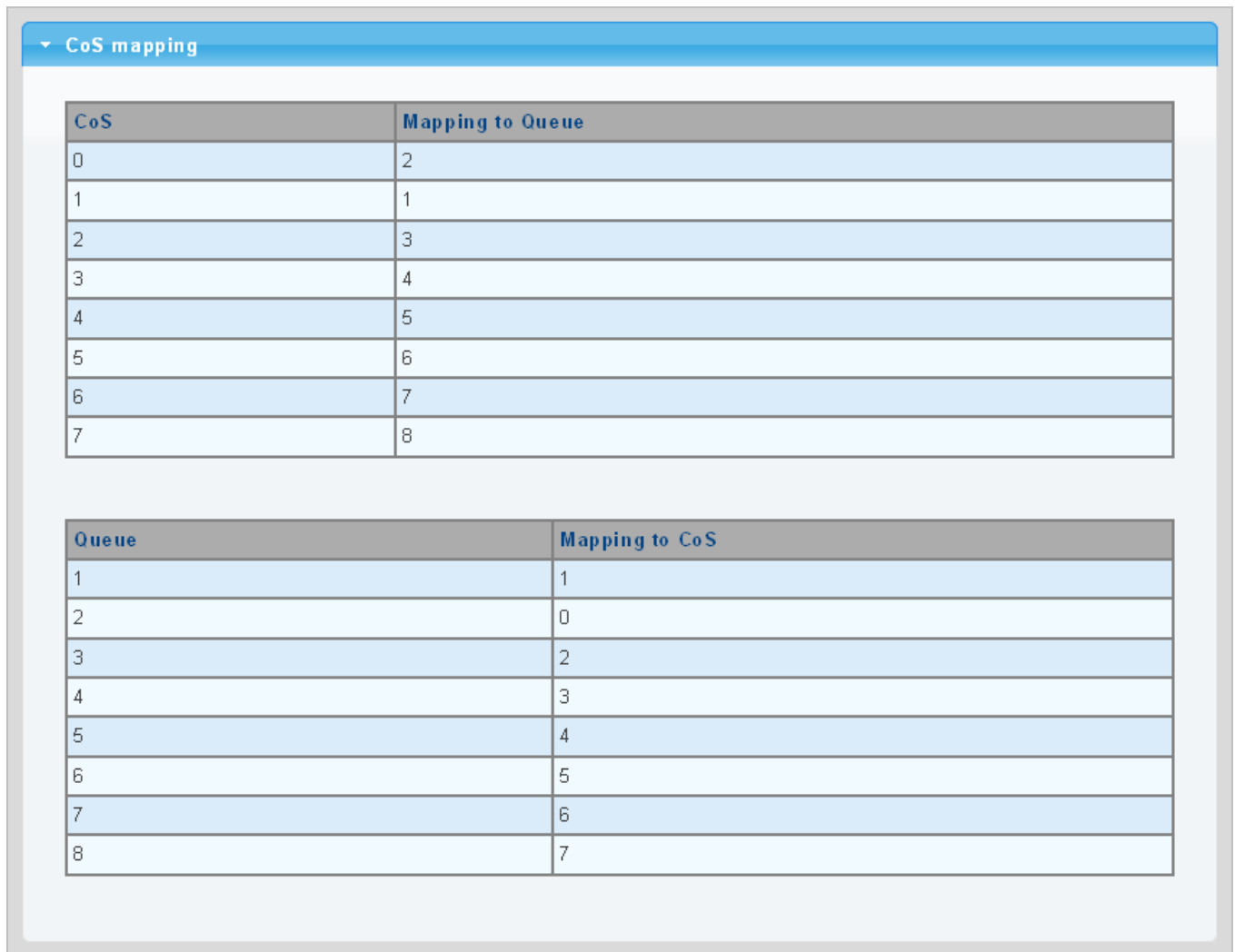

The screenshot shows a 'CoS mapping' section with two tables. The first table maps CoS values (0-7) to Queue values (2-8). The second table maps Queue values (1-8) to CoS values (1-7).

| CoS | Mapping to Queue |
|-----|------------------|
| 0 | 2 |
| 1 | 1 |
| 2 | 3 |
| 3 | 4 |
| 4 | 5 |
| 5 | 6 |
| 6 | 7 |
| 7 | 8 |

| Queue | Mapping to CoS |
|-------|----------------|
| 1 | 1 |
| 2 | 0 |
| 3 | 2 |
| 4 | 3 |
| 5 | 4 |
| 6 | 5 |
| 7 | 6 |
| 8 | 7 |

Figure 4-8-7 CoS Mapping Page Screenshot

The page includes the following fields:

| Object | Description |
|--------------------|--------------------------------------|
| • CoS | Display the current CoS value |
| • Mapping to Queue | Display the current mapping to queue |

| | |
|------------------|------------------------------------|
| • Queue | Display the current queue value |
| • Mapping to CoS | Display the current mapping to CoS |

4.8.2.5 DSCP Mapping

The DSCP to Queue and Queue to DSCP Mapping screens in [Figure 4-8-8](#) & [Figure 4-8-9](#) appear.

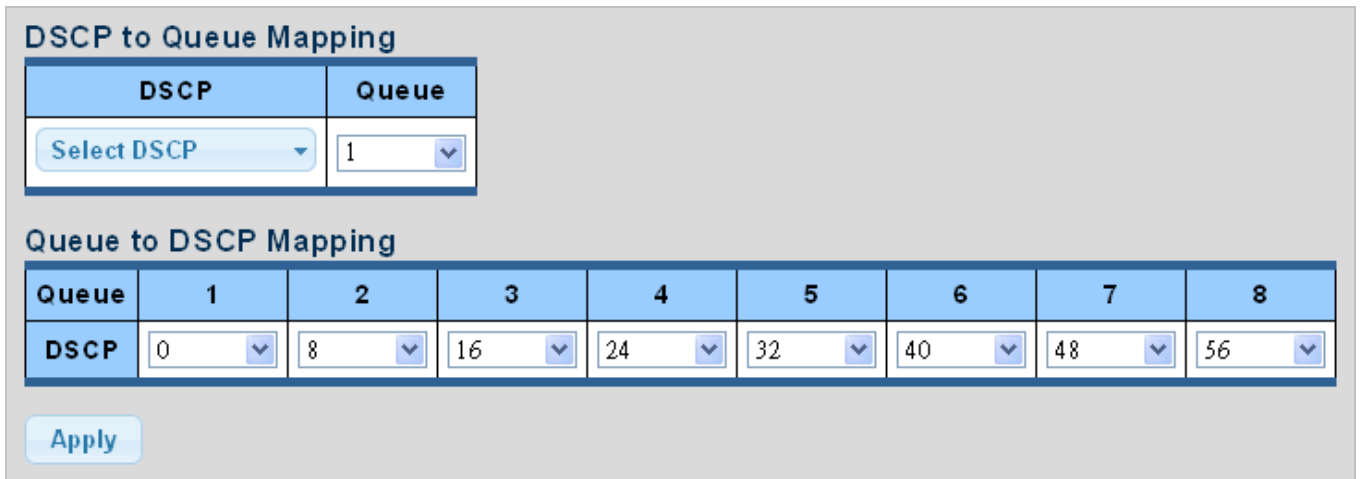

Figure 4-8-8 DSCP to Queue and Queue to DSCP Mapping Page Screenshot

The page includes the following fields:

| Object | Description |
|---------|---|
| • Queue | Select Queue value from this drop-down list |
| • DSCP | Select DSCP value from this drop-down list |

Buttons

: Click to apply changes.

▼ DSCP mapping

| DSCP | Mapping to Queue |
|------|------------------|
| 0 | 1 |
| 1 | 1 |
| 2 | 1 |
| 3 | 1 |
| 4 | 1 |
| 5 | 1 |
| 6 | 1 |
| 7 | 1 |
| 8 | 1 |
| 9 | 1 |
| 10 | 1 |
| 11 | 1 |
| 12 | 1 |
| 13 | 1 |
| 14 | 1 |
| 15 | 1 |
| 16 | 1 |
| 17 | 1 |
| 18 | 1 |
| 19 | 1 |
| 20 | 1 |
| 21 | 1 |
| 22 | 1 |
| 23 | 1 |
| 24 | 1 |
| 25 | 1 |
| 26 | 1 |
| 27 | 1 |
| 28 | 1 |
| 29 | 1 |
| 30 | 1 |
| 31 | 1 |
| 32 | 1 |
| 33 | 1 |
| 34 | 1 |
| 35 | 1 |
| 36 | 1 |
| 37 | 1 |
| 38 | 1 |
| 39 | 1 |
| 40 | 1 |
| 41 | 1 |
| 42 | 1 |
| 43 | 1 |
| 44 | 1 |
| 45 | 1 |
| 46 | 1 |
| 47 | 1 |
| 48 | 1 |
| 49 | 1 |
| 50 | 1 |
| 51 | 1 |
| 52 | 1 |
| 53 | 1 |
| 54 | 1 |
| 55 | 1 |
| 56 | 1 |
| 57 | 1 |
| 58 | 1 |
| 59 | 1 |
| 60 | 8 |
| 61 | 8 |
| 62 | 8 |
| 63 | 8 |

| Queue | Mapping to DSCP |
|-------|-----------------|
| 1 | 0 |
| 2 | 8 |
| 3 | 16 |
| 4 | 24 |
| 5 | 32 |
| 6 | 40 |
| 7 | 48 |
| 8 | 56 |

Figure 4-8-9 DSCP Mapping Page Screenshot

The page includes the following fields:

| Object | Description |
|--------------------|--------------------------------------|
| • DSCP | Display the current CoS value |
| • Mapping to Queue | Display the current mapping to queue |
| • Queue | Display the current queue value |
| • Mapping to DSCP | Display the current mapping to DSCP |

4.8.2.6 IP Precedence Mapping

The IP Precedence to Queue and Queue to IP Precedence Mapping screens in [Figure 4-8-10](#) & [Figure 4-8-11](#) appear.

IP Precedence to Queue Mapping

| IP Precedence | 0 | 1 | 2 | 3 | 4 | 5 | 6 | 7 |
|---------------|-----|-----|-----|-----|-----|-----|-----|-----|
| Queue | 1 ▾ | 2 ▾ | 3 ▾ | 4 ▾ | 5 ▾ | 6 ▾ | 7 ▾ | 8 ▾ |

Queue to IP Precedence Mapping

| Queue | 1 | 2 | 3 | 4 | 5 | 6 | 7 | 8 |
|---------------|-----|-----|-----|-----|-----|-----|-----|-----|
| IP Precedence | 0 ▾ | 1 ▾ | 2 ▾ | 3 ▾ | 4 ▾ | 5 ▾ | 6 ▾ | 7 ▾ |

Apply

Figure 4-8-10 IP Precedence to Queue and Queue to IP Precedence Mapping Page Screenshot

The page includes the following fields:

| Object | Description |
|-----------------|---|
| • Queue | Select Queue value from this drop-down list |
| • IP Precedence | Select IP Precedence value from this drop-down list |

Buttons

Apply: Click to apply changes.

▾ IP Precedence mapping

| IP Precedence | Mapping to Queue |
|---------------|------------------|
| 0 | 1 |
| 1 | 2 |
| 2 | 3 |
| 3 | 4 |
| 4 | 5 |
| 5 | 6 |
| 6 | 7 |
| 7 | 8 |

| Queue | Mapping to IP Precedence |
|-------|--------------------------|
| 1 | 0 |
| 2 | 1 |
| 3 | 2 |
| 4 | 3 |
| 5 | 4 |
| 6 | 5 |
| 7 | 6 |
| 8 | 7 |

Figure 4-8-11 IP Precedence Mapping Page Screenshot

The page includes the following fields:

| Object | Description |
|----------------------------|--|
| • IP Precedence | Display the current CoS value |
| • Mapping to Queue | Display the current mapping to queue |
| • Queue | Display the current queue value |
| • Mapping to IP Precedence | Display the current mapping to IP Precedence |

4.8.3 QoS Basic Mode

4.8.3.1 Global Settings

The Basic Mode Global Settings and QoS Information screens in [Figure 4-8-12](#) & [Figure 4-8-13](#) appear.

| Basic Mode Global Settings | |
|--------------------------------------|---|
| Trust Mode | <input checked="" type="radio"/> CoS/802.1p <input type="radio"/> DSCP <input type="radio"/> CoS/802.1p-DSCP <input type="radio"/> IP Precedence <input type="radio"/> None |
| <input type="button" value="Apply"/> | |

Figure 4-8-12 Basic Mode Global Settings Page Screenshot

The page includes the following fields:

| Object | Description |
|--------------|------------------|
| • Trust Mode | Set the QoS mode |

Buttons

: Click to apply changes.

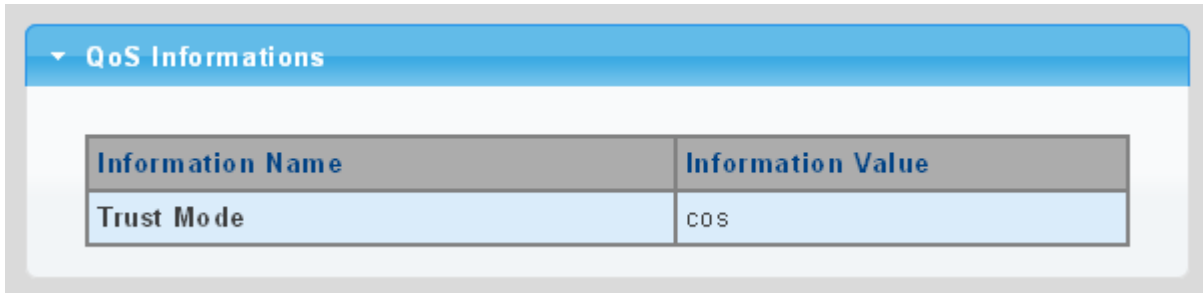

Figure 4-8-13 QoS Information Page Screenshot

The page includes the following fields:

| Object | Description |
|--------------|------------------------------|
| • Trust Mode | Display the current QoS mode |

4.8.3.2 Port Settings

The QoS Port Setting and Status screens in [Figure 4-8-14](#) & [Figure 4-8-15](#) appear.

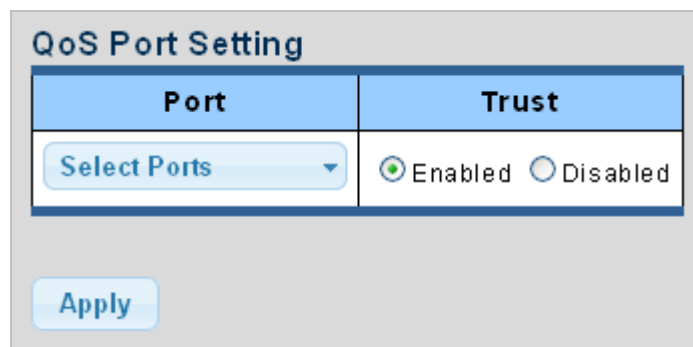



Figure 4-8-14 Basic Mode Global Settings Page Screenshot

The page includes the following fields:

| Object | Description |
|--------------|---|
| • Port | Select port number from this drop-down list |
| • Trust Mode | Enable or disable the trust mode |

Buttons

: Click to apply changes.

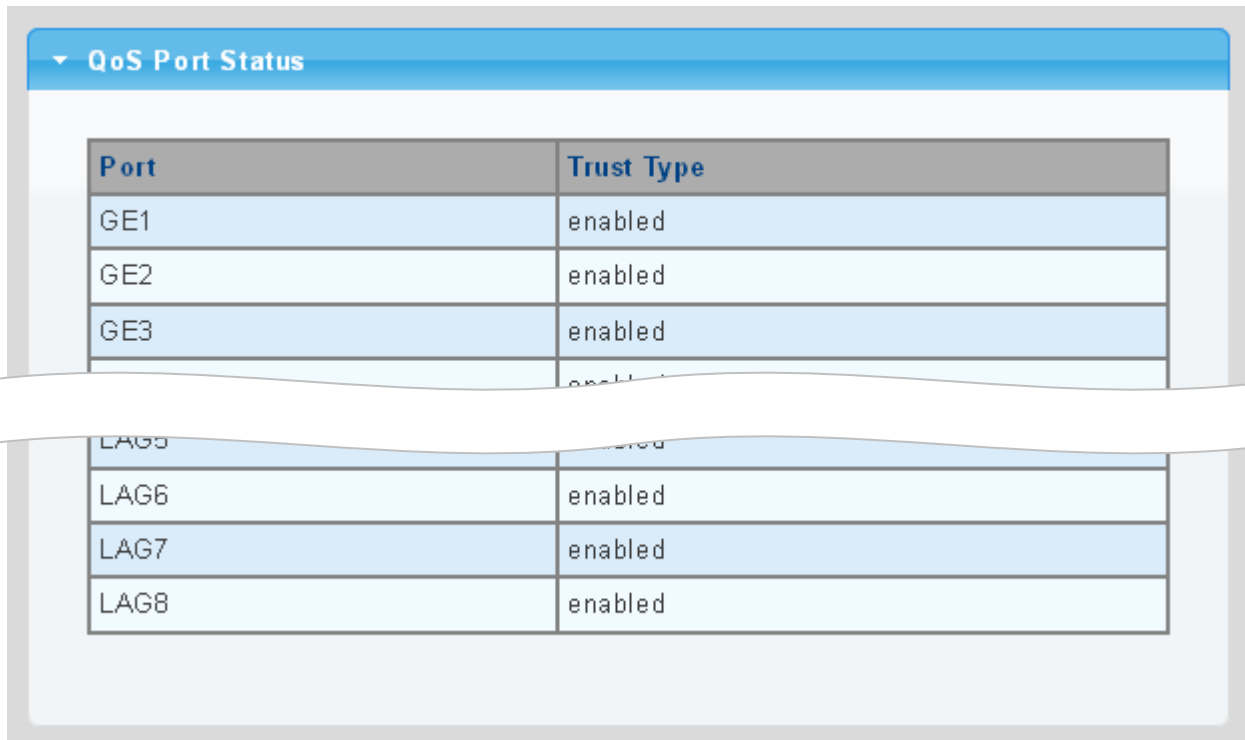

Figure 4-8-15 QoS Port Status Page Screenshot

The page includes the following fields:

| Object | Description |
|--------------|--|
| • Port | The switch port number of the logical port |
| • Trust Mode | Display the current trust type |

4.8.4 Rate Limit

Configure the switch port rate limit for the switch port on this page.

4.8.4.1 Ingress Bandwidth Control

This page provides to select the ingress bandwidth preamble. The Ingress Bandwidth Control Setting and Status screens in [Figure 4-8-16](#) & [Figure 4-8-17](#) appear.

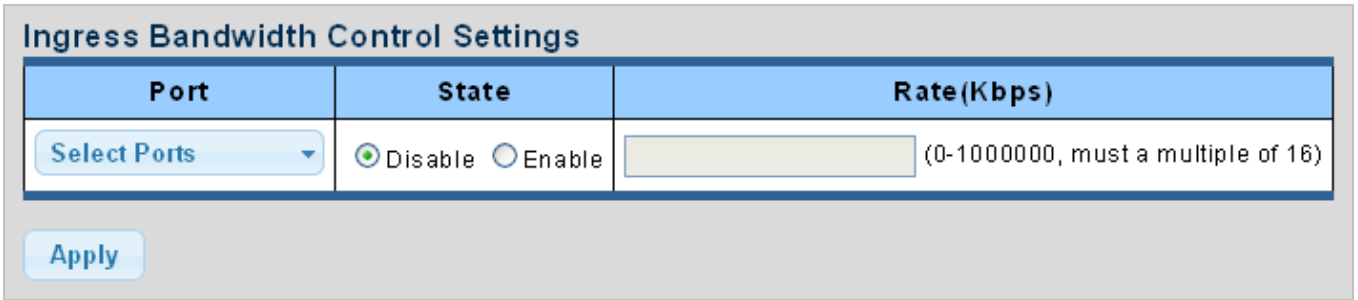

Figure 4-8-16 Ingress Bandwidth Control Settings Page Screenshot

The page includes the following fields:

| Object | Description |
|---------------|--|
| • Port | Select port number from this drop-down list |
| • State | Enable or disable the port rate policer. The default value is "Disabled". |
| • Rate (Kbps) | Configure the rate for the port policer. The default value is "unlimited". Valid values are in the range 0 to 1000000. |

Buttons



: Click to apply changes.

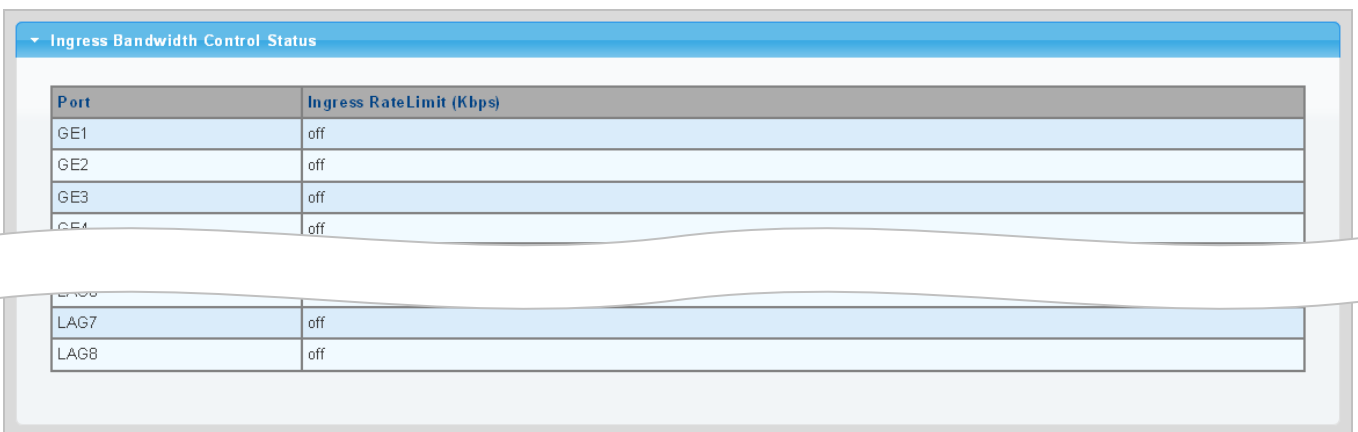

| Port | Ingress RateLimit (Kbps) |
|------|--------------------------|
| GE1 | off |
| GE2 | off |
| GE3 | off |
| GE4 | off |
| LAG7 | off |
| LAG8 | off |

Figure 4-8-17 Ingress Bandwidth Control Status Page Screenshot

The page includes the following fields:

| Object | Description |
|-----------------------------|--|
| • Port | The switch port number of the logical port |
| • Ingress Rate Limit (Kbps) | Display the current ingress rate limit |

4.8.4.2 Egress Bandwidth Control

This page provides to select the egress bandwidth preamble. The Egress Bandwidth Control Setting and Status screens in Figure 4-8-18 & Figure 4-8-19 appear.

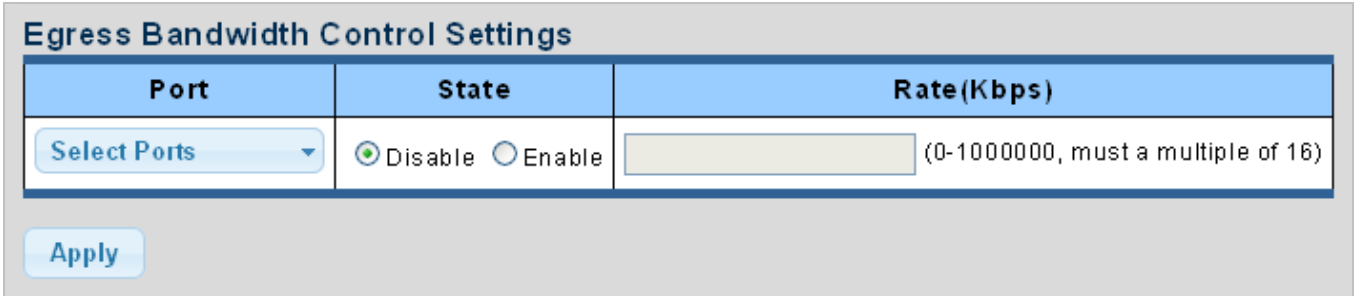

The screenshot shows the 'Egress Bandwidth Control Settings' page. It features a table with three columns: 'Port', 'State', and 'Rate(Kbps)'. The 'Port' column contains a dropdown menu labeled 'Select Ports'. The 'State' column has radio buttons for 'Disable' (selected) and 'Enable'. The 'Rate(Kbps)' column has a text input field with a placeholder '(0-1000000, must a multiple of 16)'. Below the table is an 'Apply' button.

Figure 4-8-18 Egress Bandwidth Control Settings Page Screenshot

The page includes the following fields:

| Object | Description |
|---|---|
| <ul style="list-style-type: none"> • Port | Select port number from this drop-down list |
| <ul style="list-style-type: none"> • State | Enable or disable the port rate policer. The default value is " Disabled ". |
| <ul style="list-style-type: none"> • Rate (Kbps) | Configure the rate for the port policer. The default value is " unlimited ". Valid values are in the range 0 to 1000000 . |

Buttons

: Click to apply changes.

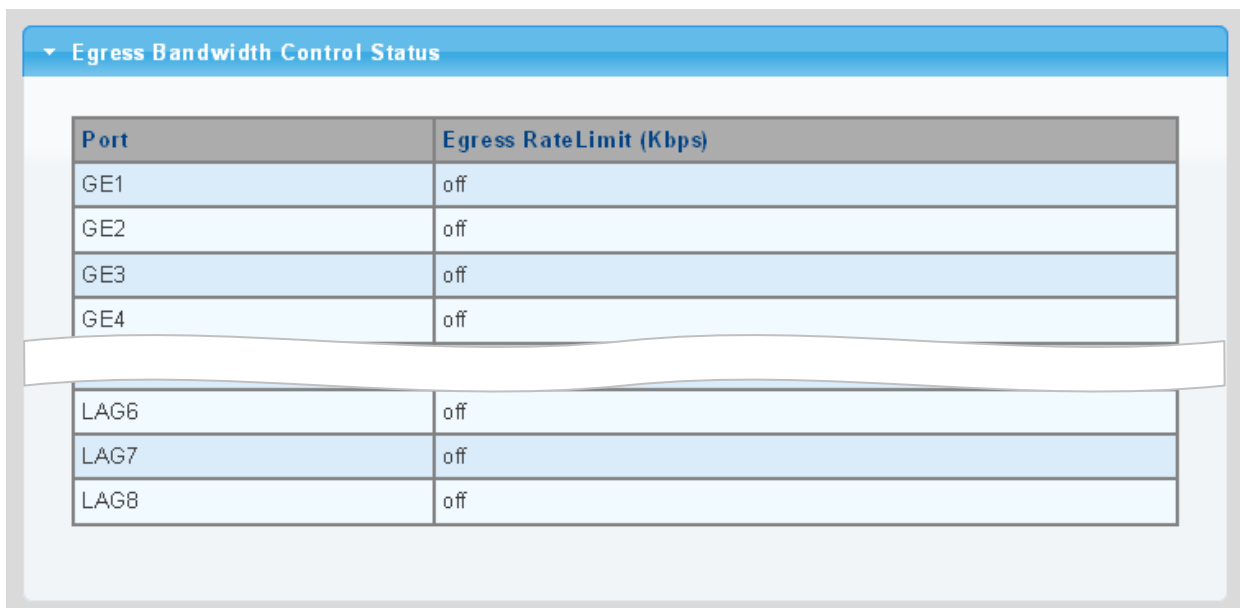

The screenshot shows the 'Egress Bandwidth Control Status' page. It features a table with two columns: 'Port' and 'Egress RateLimit (Kbps)'. The table lists ports GE1, GE2, GE3, GE4, LAG6, LAG7, and LAG8, all with a status of 'off'.

| Port | Egress RateLimit (Kbps) |
|------|-------------------------|
| GE1 | off |
| GE2 | off |
| GE3 | off |
| GE4 | off |
| LAG6 | off |
| LAG7 | off |
| LAG8 | off |

Figure 4-8-19 Egress Bandwidth Control Status Page Screenshot

The page includes the following fields:

| Object | Description |
|----------------------------|--|
| • Port | The switch port number of the logical port |
| • Egress Rate Limit (Kbps) | Display the current egress rate limit |

4.8.4.3 Egress Queue

The Egress Queue Bandwidth Control Settings and Status screens in [Figure 4-8-20](#) & [Figure 4-8-21](#) appear.

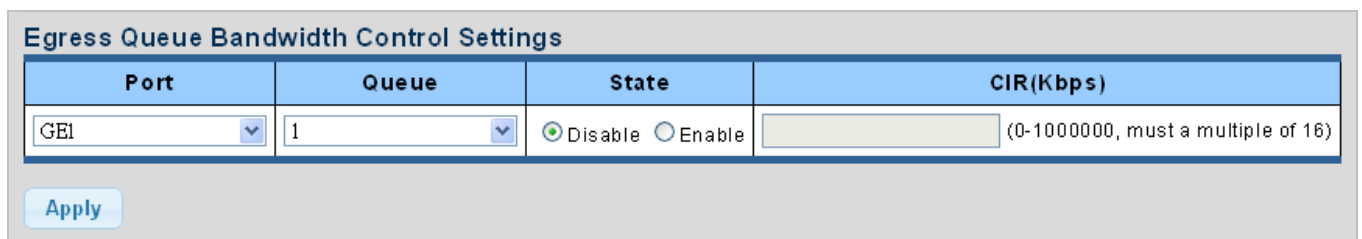

The screenshot shows the 'Egress Queue Bandwidth Control Settings' page. It features a table with four columns: Port, Queue, State, and CIR(Kbps). The Port column has a dropdown menu with 'GE1' selected. The Queue column has a dropdown menu with '1' selected. The State column has radio buttons for 'Disable' (selected) and 'Enable'. The CIR(Kbps) column has a text input field and a note '(0-1000000, must a multiple of 16)'. Below the table is an 'Apply' button.

Figure 4-8-20 Egress Queue Bandwidth Settings Page Screenshot

The page includes the following fields:

| Object | Description |
|--------------|---|
| • Port | Select port number from this drop-down list |
| • Queue | Select queue number from this drop-down list |
| • State | Enable or disable the port rate policer. The default value is "Disabled". |
| • CIR (Kbps) | Configure the CIR for the port policer. The default value is "unlimited". Valid values are in the range 0 to 1000000. |

Buttons



: Click to apply changes.

| GE1 Egress Per Queue Status | |
|-----------------------------|-------------------|
| Queue Id | Rate Limit (Kbps) |
| 1 | off |
| 2 | off |
| 3 | off |
| 4 | off |
| 5 | off |
| 6 | off |
| 7 | off |
| 8 | off |

Figure 4-8-21 Egress Queue Status Page Screenshot

The page includes the following fields:

| Object | Description |
|---------------------|--------------------------------|
| • Queue ID | Display the current queue ID |
| • Rate Limit (Kbps) | Display the current rate limit |

4.8.5 Voice VLAN

4.5.8.1 Introduction to Voice VLAN

Configure the switch port rate limit for the switch port on this page.

Voice VLAN is specially configured for the user voice data traffic. By setting a Voice VLAN and adding the ports of the connected voice equipments to Voice VLAN, the user will be able to configure QoS (Quality of service) service for voice data, and improve voice data traffic transmission priority to ensure the calling quality.

The switch can judge if the data traffic is the voice data traffic from specified equipment according to the source MAC address field of the data packet entering the port. The packet with the source MAC address complying with the system defined voice equipment **OUI (Organizationally Unique Identifier)** will be considered the voice data traffic and transmitted to the Voice VLAN.

The configuration is based on MAC address, acquiring a mechanism in which every voice equipment transmitting information through the network has got its unique MAC address. VLAN will trace the address belongs to specified MAC. By This means, VLAN allows the voice equipment always belong to Voice VLAN when relocated physically. The greatest advantage of the VLAN is the equipment can be automatically placed into Voice VLAN according to its voice traffic which will be transmitted at specified priority. Meanwhile, when voice equipment is physically relocated, it still belongs to the Voice VLAN without any further configuration modification, which is because it is based on voice equipment other than switch port.



The Voice VLAN feature enables the voice traffic to forward on the Voice VLAN, and then the switch can be classified and scheduled to network traffic. **It is recommended there are two VLANs on a port -- one for voice, one for data.**



Before connecting the IP device to the switch, **the IP phone should configure the voice VLAN ID correctly.** It should be configured through its own GUI.

4.8.5.2 Properties

The Voice VLAN feature enables voice traffic to forward on the Voice VLAN, and then the switch can be classified and scheduled to network traffic. It is recommended that there are two VLANs on a port -- one for voice, one for data.

Before connecting the IP device to the switch, the IP phone should configure the voice VLAN ID correctly. It should be configured through its own GUI. This page provides to select the ingress bandwidth preamble. The Ingress Bandwidth Control Setting/Status screens in [Figure 4-8-22](#) & [Figure 4-8-23](#) appear.

Properties

| | |
|---------------------------------|---|
| Voice VLAN State | <input type="radio"/> Enabled <input checked="" type="radio"/> Disabled |
| Voice VLAN Id | <input type="text" value=""/> <input type="checkbox"/> Enable |
| Remark Cos/802.1p | <input type="text" value="6"/> <input type="button" value="v"/> |
| 1p remark | <input type="radio"/> Enabled <input checked="" type="radio"/> Disabled |
| Aging Time(30-65536 min) | <input type="text" value="1440"/> |

Figure 4-8-22 Properties Page Screenshot

The page includes the following fields:

| Object | Description |
|--|--|
| <ul style="list-style-type: none"> • Voice VLAN State | <p>Indicates the Voice VLAN mode operation. We must disable MSTP feature before we enable Voice VLAN. It can avoid the conflict of ingress filter. Possible modes are:</p> <ul style="list-style-type: none"> ■ Enabled: Enable Voice VLAN mode operation. ■ Disabled: Disable Voice VLAN mode operation |
| <ul style="list-style-type: none"> • Voice VLAN ID | <p>Indicates the Voice VLAN ID. It should be a unique VLAN ID in the system and cannot equal each port PVID. It is conflict configuration if the value equal management VID, MVR VID, PVID, etc.</p> <p>The allowed range is 1 to 4095.</p> |
| <ul style="list-style-type: none"> • Remark CoS/802.1p | <p>Select 802.1p value from this drop-down list</p> |
| <ul style="list-style-type: none"> • 1p Remark | <p>Enable or disable 802.1p remark</p> |
| <ul style="list-style-type: none"> • Aging Time (30-65536 min) | <p>The time after which a port is removed from the Voice VLAN when VoIP traffic is no longer received on the port.</p> <p>(\Default: 1440 minutes).</p> |

Buttons

Apply: Click to apply changes.

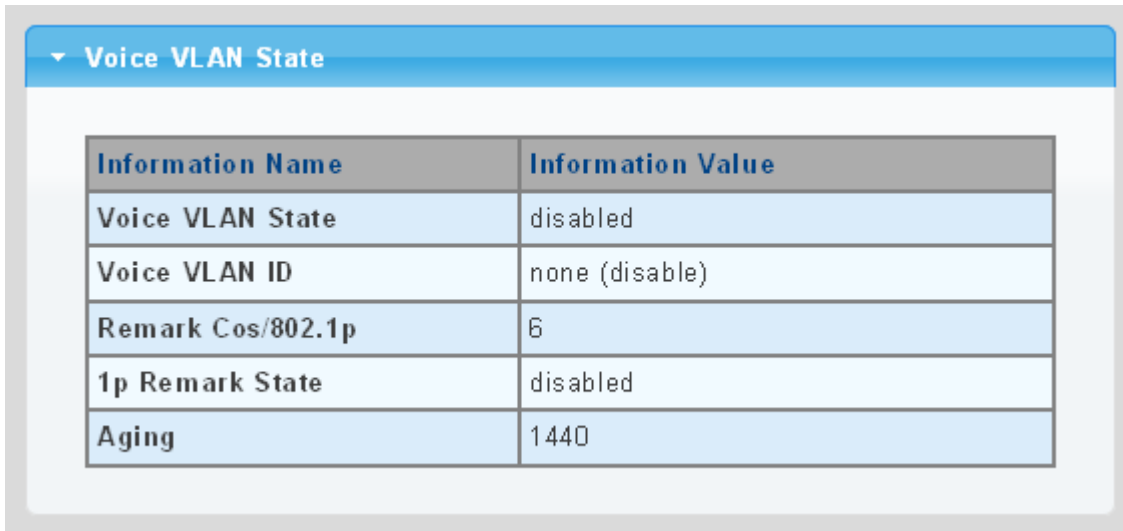

| Information Name | Information Value |
|-------------------|-------------------|
| Voice VLAN State | disabled |
| Voice VLAN ID | none (disable) |
| Remark Cos/802.1p | 6 |
| 1p Remark State | disabled |
| Aging | 1440 |

Figure 4-8-23 Properties Page Screenshot

The page includes the following fields:

| Object | Description |
|----------------------------|--|
| • Voice VLAN State | Display the current voice VLAN state. |
| • Voice VLAN ID | Display the current voice VLAN ID. |
| • Remark CoS/802.1p | Display the current remark CoS/802.1p. |
| • 1p Remark | Display the current 1p remark. |
| • Aging | Display the current aging time. |

4.8.5.3 Telephony OUI MAC Setting

Configure VOICE VLAN OUI table on this Page. The Telephony OUI MAC Setting screens in [Figure 4-8-24](#) & [Figure 4-8-25](#) appear.

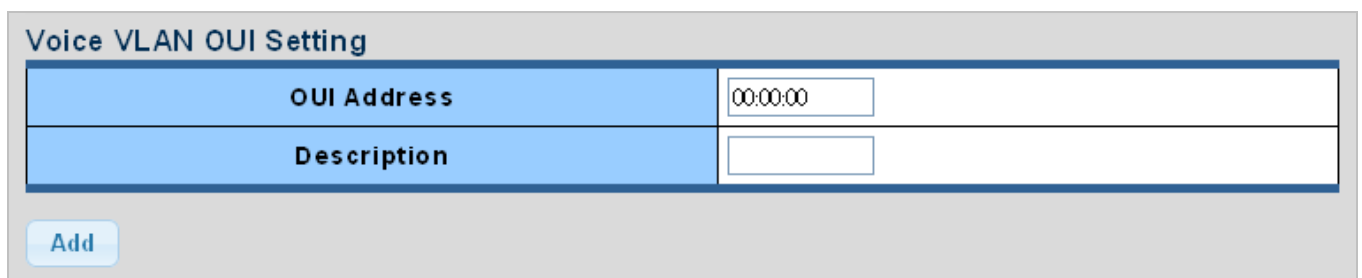

| OUI Address | Description |
|---------------------------------------|----------------------|
| <input type="text" value="00:00:00"/> | <input type="text"/> |

Add

Figure 4-8-24 Voice VLAN OUI Settings Page Screenshot

The page includes the following fields:

| Object | Description |
|--|---|
| <ul style="list-style-type: none"> • OUI Address | A telephony OUI address is a globally unique identifier assigned to a vendor by IEEE. It must be 6 characters long and the input format is "xx:xx:xx" (x is a hexadecimal digit). |
| <ul style="list-style-type: none"> • Description | User-defined text that identifies the VoIP devices |

Buttons

Add: Click to add voice VLAN OUI setting.

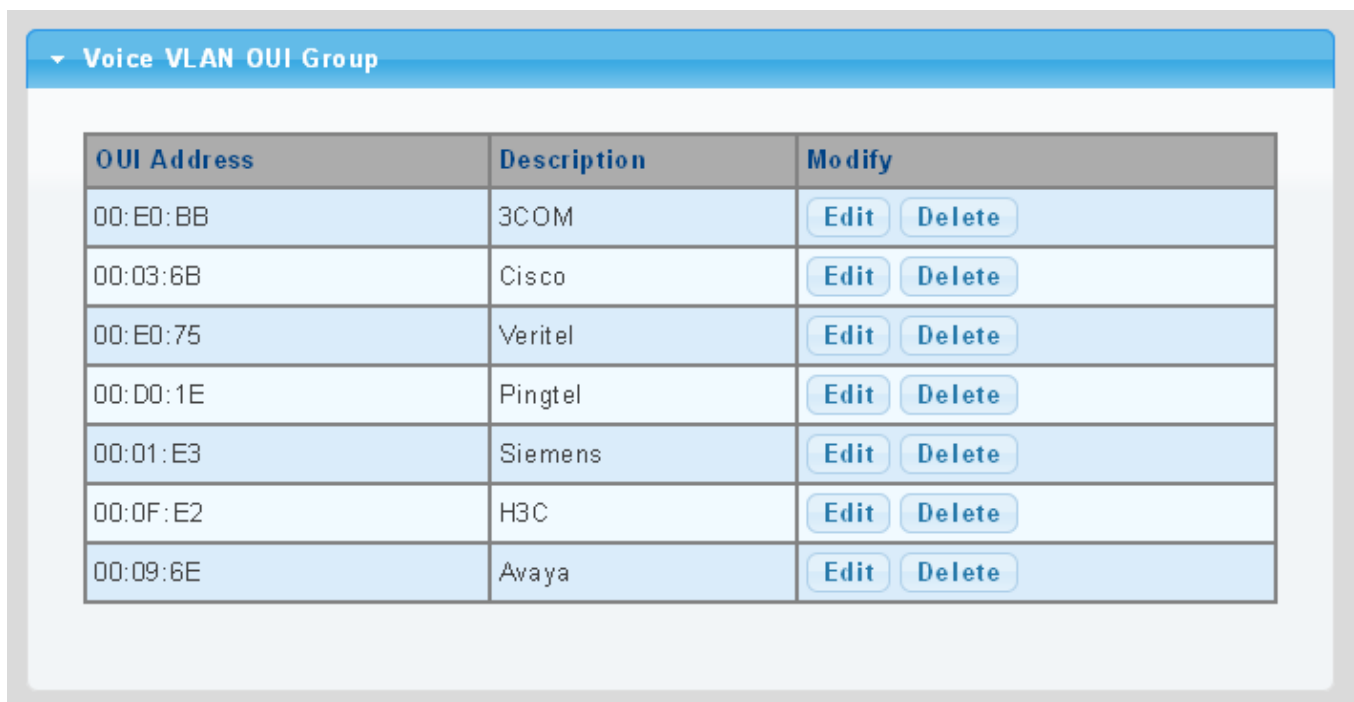

Figure 4-8-25 Voice VLAN OUI Group Page Screenshot

The page includes the following fields:

| Object | Description |
|--|---|
| <ul style="list-style-type: none"> • OUI Address | Display the current OUI address |
| <ul style="list-style-type: none"> • Description | Display the current description |
| <ul style="list-style-type: none"> • Modify | <p>Click Edit to edit voice VLAN OUI group parameter</p> <p>Click Delete to delete voice VLAN OUI group parameter</p> |

4.8.5.4 Telephony OUI Port Setting

The Voice VLAN feature enables voice traffic forwarding on the Voice VLAN, then the switch can classify and schedule network traffic. It is recommended that there be two VLANs on a port - one for voice and one for data. Before connecting the IP device to the switch, the IP phone should configure the voice VLAN ID correctly. It should be configured through its own GUI. The Telephony OUI MAC Setting screens in [Figure 4-8-26](#) & [Figure 4-8-27](#) appear.

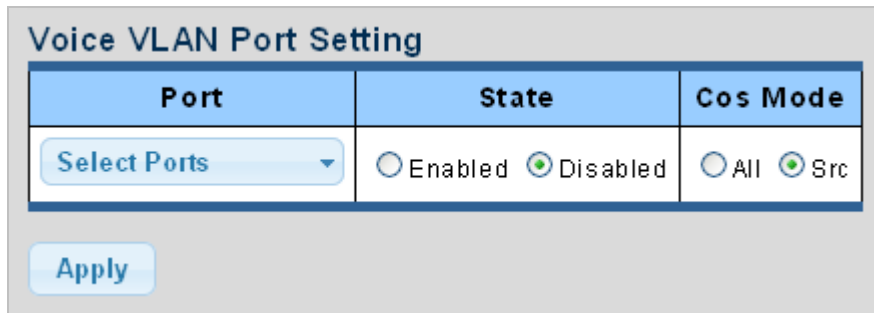

Figure 4-8-26 Voice VLAN Port Setting Page Screenshot

The page includes the following fields:

| Object | Description |
|------------|---|
| • Port | Select port number for this drop down list |
| • State | Enable or disable the voice VLAN port setting. The default value is "Disabled". |
| • CoS Mode | Select the current CoS mode |

Buttons

: Click to apply changes.

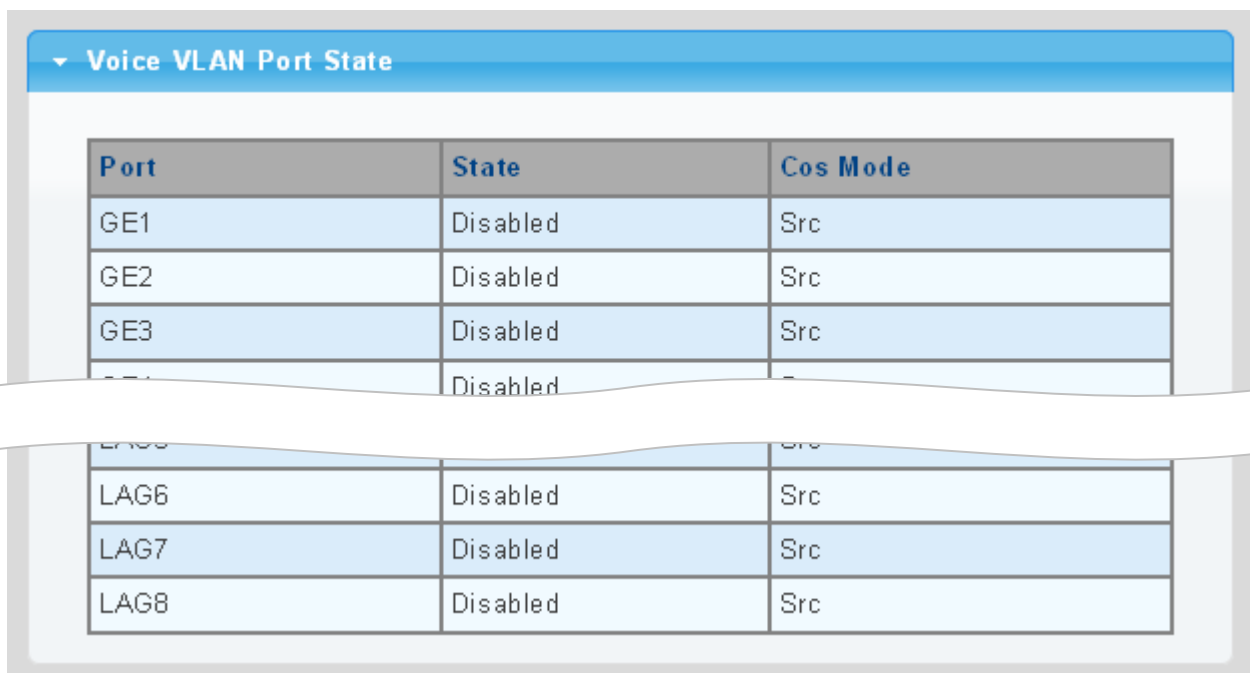

Figure 4-8-27 Voice VLAN Port State Page Screenshot

The page includes the following fields:

| Object | Description |
|-------------------|--|
| • Port | The switch port number of the logical port |
| • State | Display the current state |
| • CoS Mode | Display the current CoS mode |

4.9 Security

This section is to control the access of the LRP Managed Switch, including the user access and management control.

The Security page contains links to the following main topics:

- 802.1X
- RADIUS Server
- TACACS+ Server
- AAA
- Access
- Management Access Method
- DHCP Snooping
- Dynamic ARP Inspection
- IP Source Guard
- Port Security
- DoS
- Storm Control

4.9.1 802.1X

Overview of 802.1X (Port-based) Authentication

In the 802.1X-world, the user is called the supplicant, the switch is the authenticator, and the RADIUS server is the authentication server. The switch acts as the man-in-the-middle, forwarding requests and responses between the supplicant and the authentication server. Frames sent between the supplicant and the switch are special 802.1X frames, known as **EAPOL (EAP Over LANs)** frames. EAPOL frames encapsulate **EAP PDUs** (RFC3748). Frames sent between the switch and the RADIUS server are RADIUS packets. RADIUS packets also encapsulate EAP PDUs together with other attributes like the switch's IP address, name, and the supplicant's port number on the switch. EAP is very flexible, in that it allows for different authentication methods, like **MD5-Challenge**, **PEAP**, and **TLS**. The important thing is that the authenticator (the switch) doesn't need to know which authentication method the supplicant and the authentication server are using, or how many information exchange frames are needed for a particular method. The switch simply encapsulates the EAP part of the frame into the relevant type (EAPOL or RADIUS) and forwards it.

When authentication is complete, the RADIUS server sends a special packet containing a success or failure indication. Besides forwarding this decision to the supplicant, the switch uses it to open up or block traffic on the switch port connected to the supplicant.

Overview of User Authentication

It is allowed to configure the LRP Managed Switch to authenticate users logging into the system for management access using local or remote authentication methods, such as Telnet and Web browser. This LRP Managed Switch provides secure network management access using the following options:

- Remote Authentication Dial-in User Service (RADIUS)
- Terminal Access Controller Access Control System Plus (TACACS+)
- Local user name and Privilege Level control

4.9.1.1 Understanding IEEE 802.1X Port-based Authentication

The IEEE 802.1X standard defines a client-server-based access control and authentication protocol that restricts unauthorized clients from connecting to a LAN through publicly accessible ports. The authentication server authenticates each client connected to a switch port before making available any services offered by the switch or the LAN.

Until the client is authenticated, 802.1X access control allows only **Extensible Authentication Protocol over LAN (EAPOL)** traffic through the port to which the client is connected. After authentication is successful, normal traffic can pass through the port.

This section includes this conceptual information:

- Device Roles
- Authentication Initiation and Message Exchange
- Ports in Authorized and Unauthorized States

■ Device Roles

With 802.1X port-based authentication, the devices in the network have specific roles as shown below.

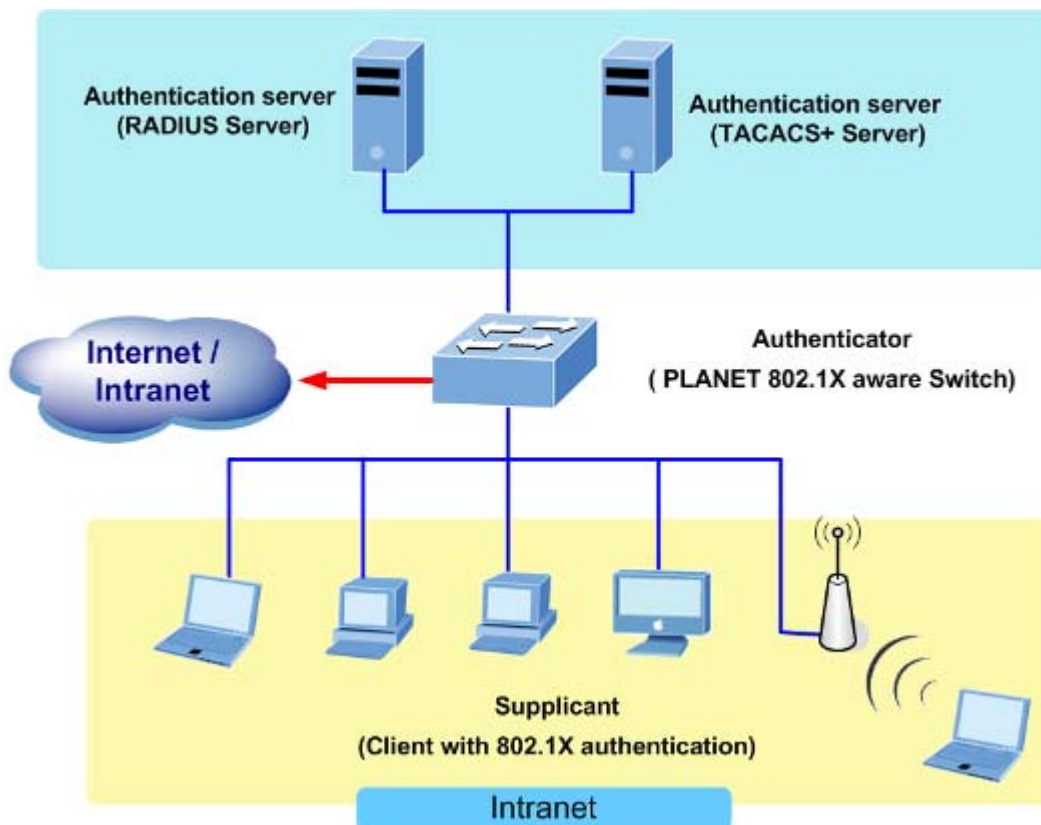

Figure 4-9-1

- **Client**—the device (workstation) that requests access to the LAN and switch services and responds to requests from the switch. The workstation must be running 802.1X-compliant client software such as that offered in the Microsoft Windows XP operating system. (The client is the *supplicant* in the IEEE 802.1X specification.)

- **Authentication server**—performs the actual authentication of the client. The authentication server validates the identity of the client and notifies the switch whether or not the client is authorized to access the LAN and switch services. Because the switch acts as the proxy, the authentication service is transparent to the client. In this release, the Remote Authentication Dial-In User Service (RADIUS) security system with **Extensible Authentication Protocol (EAP)** extensions is the only supported authentication server; it is available in Cisco Secure Access Control Server version 3.0. RADIUS operates in a client/server model in which secure authentication information is exchanged between the RADIUS server and one or more RADIUS clients.
- **Switch (802.1X device)**—controls the physical access to the network based on the authentication status of the client. The switch acts as an intermediary (proxy) between the client and the authentication server, requesting identity information from the client, verifying that information with the authentication server, and relaying a response to the client. The switch includes the RADIUS client, which is responsible for encapsulating and decapsulating the Extensible Authentication Protocol (EAP) frames and interacting with the authentication server. When the switch receives EAPOL frames and relays them to the authentication server, the Ethernet header is stripped and the remaining EAP frame is re-encapsulated in the RADIUS format. The EAP frames are not modified or examined during encapsulation, and the authentication server must support EAP within the native frame format. When the switch receives frames from the authentication server, the server's frame header is removed, leaving the EAP frame, which is then encapsulated for Ethernet and sent to the client.

■ Authentication Initiation and Message Exchange

The switch or the client can initiate authentication. If you enable authentication on a port by using the **dot1x port-control auto** interface configuration command, the switch must initiate authentication when it determines that the port link state transitions from down to up. It then sends an EAP-request/identity frame to the client to request its identity (typically, the switch sends an initial identity/request frame followed by one or more requests for authentication information). Upon receipt of the frame, the client responds with an EAP-response/identity frame.

However, if during bootup, the client does not receive an EAP-request/identity frame from the switch, the client can initiate authentication by sending an EAPOL-start frame, which prompts the switch to request the client's identity



If 802.1X is not enabled or supported on the network access device, any EAPOL frames from the client are dropped. If the client does not receive an EAP-request/identity frame after three attempts to start authentication, the client transmits frames as if the port is in the authorized state. A port in the authorized state effectively means that the client has been successfully authenticated.

When the client supplies its identity, the switch begins its role as the intermediary, passing EAP frames between the client and the authentication server until authentication succeeds or fails. If the authentication succeeds, the switch port becomes authorized.

The specific exchange of EAP frames depends on the authentication method being used. “[Figure 4-9-2](#)” shows a message exchange initiated by the client using the One-Time-Password (OTP) authentication method with a RADIUS server.

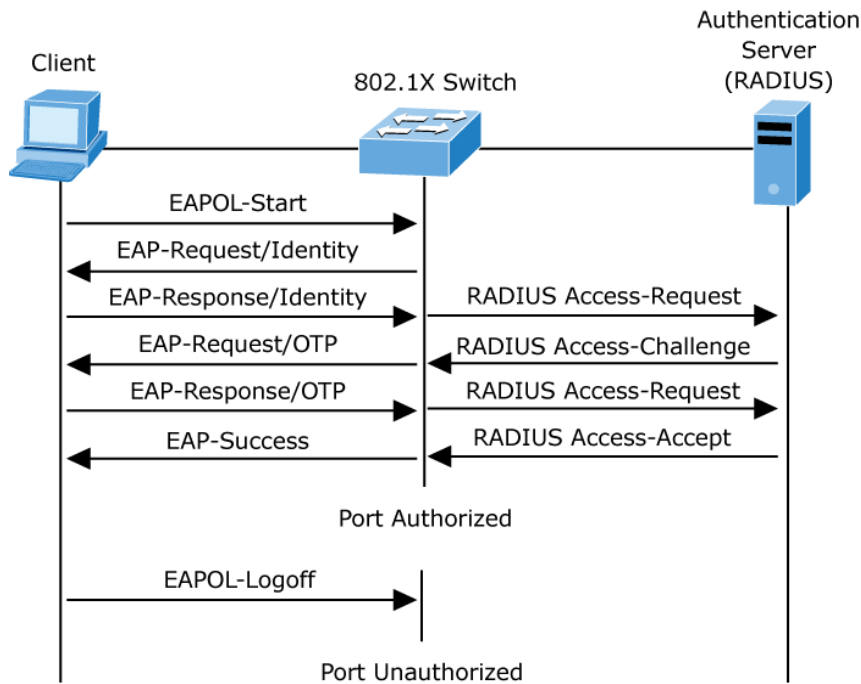

Figure 4-9-2 EAP Message Exchange

■ Ports in Authorized and Unauthorized States

The switch port state determines whether or not the client is granted access to the network. The port starts in the *unauthorized* state. While in this state, the port disallows all ingress and egress traffic except for 802.1X protocol packets. When a client is successfully authenticated, the port transitions to the *authorized* state, allowing all traffic for the client to flow normally.

If a client that does not support 802.1X is connected to an unauthorized 802.1X port, the switch requests the client's identity. In this situation, the client does not respond to the request, the port remains in the unauthorized state, and the client is not granted access to the network.

In contrast, when an 802.1X-enabled client connects to a port that is not running the 802.1X protocol, the client initiates the authentication process by sending the EAPOL-start frame. When no response is received, the client sends the request for a fixed number of times. Because no response is received, the client begins sending frames as if the port is in the authorized state

If the client is successfully authenticated (receives an Accept frame from the authentication server), the port state changes to authorized, and all frames from the authenticated client are allowed through the port. If the authentication fails, the port remains in the unauthorized state, but authentication can be retried. If the authentication server cannot be reached, the switch can retransmit the request. If no response is received from the server after the specified number of attempts, authentication fails, and network access is not granted.

When a client logs off, it sends an EAPOL-logoff message, causing the switch port to transition to the unauthorized state.

If the link state of a port transitions from up to down, or if an EAPOL-logoff frame is received, the port returns to the unauthorized state.

4.9.1.2 802.1X Setting

This page allows you to configure the IEEE 802.1X authentication system.

The IEEE 802.1X standard defines a port-based access control procedure that prevents unauthorized access to a network by requiring users to first submit credentials for authentication. One or more central servers, the backend servers, determine whether the user is allowed access to the network. These backend (RADIUS) servers are configured on the "Security→802.1X Access Control→802.1X Setting" page. The IEEE802.1X standard defines port-based operation, but non-standard variants overcome security limitations as shall be explored below.

The 802.1X Setting and Information screens in [Figure 4-9-3](#) & [Figure 4-9-4](#) appear.

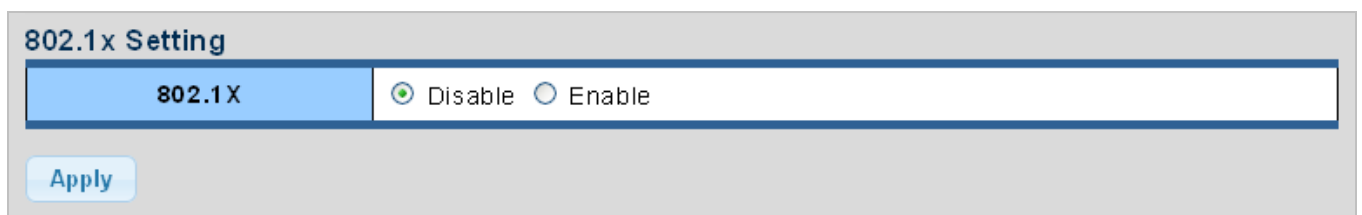

Figure 4-9-3 802.1X Setting Page Screenshot

The page includes the following fields:

| Object | Description |
|--|---|
| <ul style="list-style-type: none"> 802.1X | Indicates if NAS is globally enabled or disabled on the switch. If globally disabled, all ports are allowed forwarding of frames. |

Buttons

: Click to apply changes.

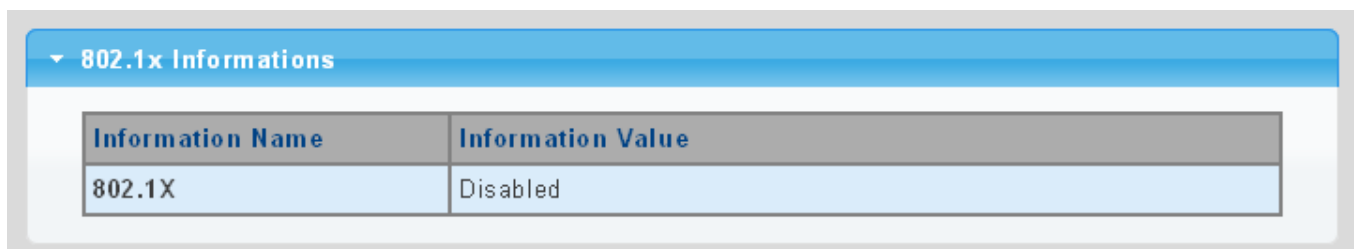

Figure 4-9-4 802.1X Information Page Screenshot

The page includes the following fields:

| Object | Description |
|--|----------------------------------|
| <ul style="list-style-type: none"> 802.1X | Display the current 802.1X state |

4.9.1.3 802.1X Port Setting

This page allows you to configure the IEEE 802.1X Port Setting. The 802.1X Port Setting screens in [Figure 4-9-5](#) & [Figure 4-9-6](#) appear.

802.1x Port Setting

| | |
|--------------------------------|---|
| Port | Select Ports ▼ |
| Mode | No Authentication ▼ |
| Reauthentication Enable | <input checked="" type="radio"/> Disable <input type="radio"/> Enable |
| Reauthentication Period | <input type="text" value="3600"/> (Range 30 - 65535, Default: 3600) |
| Quiet Period | <input type="text" value="60"/> (Range 0 - 65535, Default: 60) |
| Supplicant Period | <input type="text" value="30"/> (Range 1 - 65535, Default: 30) |
| Maximum Request Retries | <input type="text" value="2"/> (Range 1 - 10, Default: 2) |

Figure 4-9-5 802.1X Port Setting Page Screenshot

The page includes the following fields:

| Object | Description |
|---------------------------|---|
| • Port | Select port from this drop-down list |
| • Mode | <p>If NAS is globally enabled, this selection controls the port's authentication mode. The following modes are available:</p> <ul style="list-style-type: none"> ■ No Authentication ■ Authentication ■ Force Authorized <p>In this mode, the switch will send one EAPOL Success frame when the port link comes up, and any client on the port will be allowed network access without authentication.</p> ■ Force Unauthorized <p>In this mode, the switch will send one EAPOL Failure frame when the port link comes up, and any client on the port will be disallowed network access.</p> |
| • Reauthentication Enable | If checked, successfully authenticated supplicants/clients are reauthenticated after the interval specified by the Reauthentication Period. Reauthentication for |

| | |
|--|--|
| | 802.1X-enabled ports can be used to detect if a new device is plugged into a switch port or if a supplicant is no longer attached. |
| <ul style="list-style-type: none"> • Reauthentication Period | <p>Determines the period, in seconds, after which a connected client must be reauthenticated. This is only active if the Reauthentication Enabled checkbox is checked.</p> <p>Valid values are in the range 30 to 65535 seconds.</p> |
| <ul style="list-style-type: none"> • Quiet Period | Sets time to keep silent on supplicant authentication failure. |
| <ul style="list-style-type: none"> • Supplicant Period | Sets the interval for the supplicant to re-transmit EAP request/identify frame. |
| <ul style="list-style-type: none"> • Maximum Request Retries | <p>The number of times that the switch transmits an EAPOL Request Identity frame without response before considering entering the Guest VLAN is adjusted with this setting.</p> <p>The value can only be changed if the Guest VLAN option is globally enabled.</p> |

Buttons



: Click to apply changes.

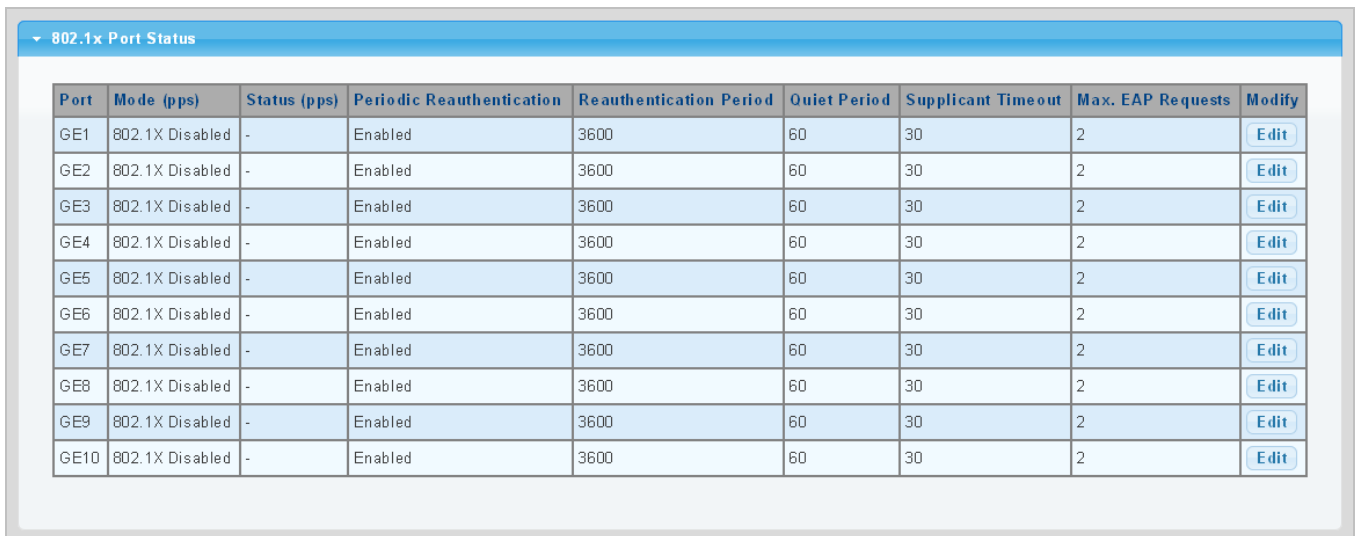

| Port | Mode (pps) | Status (pps) | Periodic Reauthentication | Reauthentication Period | Quiet Period | Supplicant Time out | Max. EAP Requests | Modify |
|------|-----------------|--------------|---------------------------|-------------------------|--------------|---------------------|-------------------|--------|
| GE1 | 802.1X Disabled | - | Enabled | 3600 | 60 | 30 | 2 | Edit |
| GE2 | 802.1X Disabled | - | Enabled | 3600 | 60 | 30 | 2 | Edit |
| GE3 | 802.1X Disabled | - | Enabled | 3600 | 60 | 30 | 2 | Edit |
| GE4 | 802.1X Disabled | - | Enabled | 3600 | 60 | 30 | 2 | Edit |
| GE5 | 802.1X Disabled | - | Enabled | 3600 | 60 | 30 | 2 | Edit |
| GE6 | 802.1X Disabled | - | Enabled | 3600 | 60 | 30 | 2 | Edit |
| GE7 | 802.1X Disabled | - | Enabled | 3600 | 60 | 30 | 2 | Edit |
| GE8 | 802.1X Disabled | - | Enabled | 3600 | 60 | 30 | 2 | Edit |
| GE9 | 802.1X Disabled | - | Enabled | 3600 | 60 | 30 | 2 | Edit |
| GE10 | 802.1X Disabled | - | Enabled | 3600 | 60 | 30 | 2 | Edit |

Figure 4-9-6 802.1X Port Status Page Screenshot

The page includes the following fields:

| Object | Description |
|-----------------------------|--|
| • Port | The switch port number of the logical port. |
| • Mode (pps) | Display the current mode. |
| • Status (pps) | Display the current status. |
| • Periodic Reauthentication | Display the current periodic reauthentication. |
| • Reauthentication Period | Display the current reauthentication period. |
| • Quiet Period | Display the current quiet period. |
| • Supplicant Timeout | Display the current supplicant timeout. |
| • Max. EAP Requests | Display the current Max. EAP requests. |
| • Modify | Click  to edit 802.1X port setting parameter. |

4.9.1.4 Guest VLAN Setting

Overview

When a Guest VLAN enabled port's link comes up, the switch starts transmitting EAPOL Request Identity frames. If the number of transmissions of such frames exceeds Max. Reauth. Count and no EAPOL frames have been received in the meantime, the switch considers entering the Guest VLAN. The interval between transmission of EAPOL Request Identity frames is configured with EAPOL Timeout. If Allow Guest VLAN if EAPOL Seen is enabled, the port will now be placed in the Guest VLAN. If disabled, the switch will first check its history to see if an EAPOL frame has previously been received on the port (this history is cleared if the port link goes down or the port's Admin State is changed), and if not, the port will be placed in the Guest VLAN. Otherwise it will not move to the Guest VLAN, but continue transmitting EAPOL Request Identity frames at the rate given by EAPOL Timeout.

Once in the Guest VLAN, the port is considered authenticated, and all attached clients on the port are allowed access on this VLAN. The switch will not transmit an EAPOL Success frame when entering the Guest VLAN.

While in the Guest VLAN, the switch monitors the link for EAPOL frames, and if one such frame is received, the switch immediately takes the port out of the Guest VLAN and starts authenticating the supplicant according to the port mode. If an EAPOL frame is received, the port will never be able to go back into the Guest VLAN if the "Allow Guest VLAN if EAPOL Seen" is disabled.

The 802.1X Guest VLAN setting screens in [Figure 4-9-7](#) & [Figure 4-9-8](#) appear.

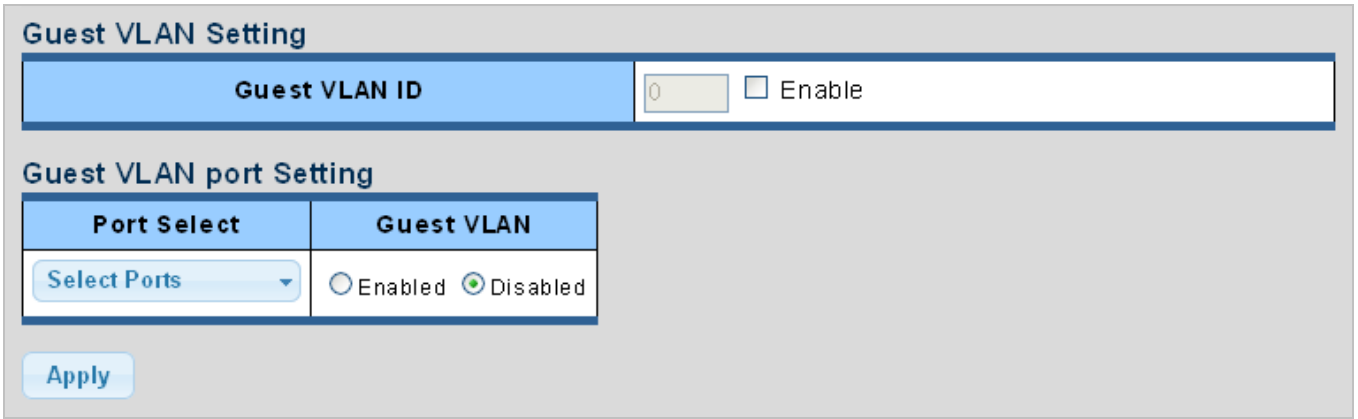



Figure 4-9-7 Guest VLAN Setting Page Screenshot

The page includes the following fields:

| Object | Description |
|--|---|
| <ul style="list-style-type: none"> • Guest VLAN ID | <p>This is the value that a port's Port VLAN ID is set to if a port is moved into the Guest VLAN. It is only changeable if the Guest VLAN option is globally enabled.</p> <p>Valid values are in the range [1~4094].</p> |
| <ul style="list-style-type: none"> • Guest VLAN Enabled | <p>A Guest VLAN is a special VLAN - typically with limited network access - on which 802.1X-unaware clients are placed after a network administrator-defined timeout. The switch follows a set of rules for entering and leaving the Guest VLAN as listed below.</p> <p>The "Guest VLAN Enabled" checkbox provides a quick way to globally enable/disable Guest VLAN functionality.</p> <ul style="list-style-type: none"> ■ When checked, the individual ports' ditto setting determines whether the port can be moved into Guest VLAN. ■ When unchecked, the ability to move to the Guest VLAN is disabled for all ports. |
| <ul style="list-style-type: none"> • Guest VLAN Port Setting | <p>When Guest VLAN is both globally enabled and enabled (checked) for a given port, the switch considers moving the port into the Guest VLAN according to the rules outlined below.</p> <p>This option is only available for EAPOL-based modes, i.e.</p> <ul style="list-style-type: none"> • Port-based 802.1X |

Buttons

: Click to apply changes.

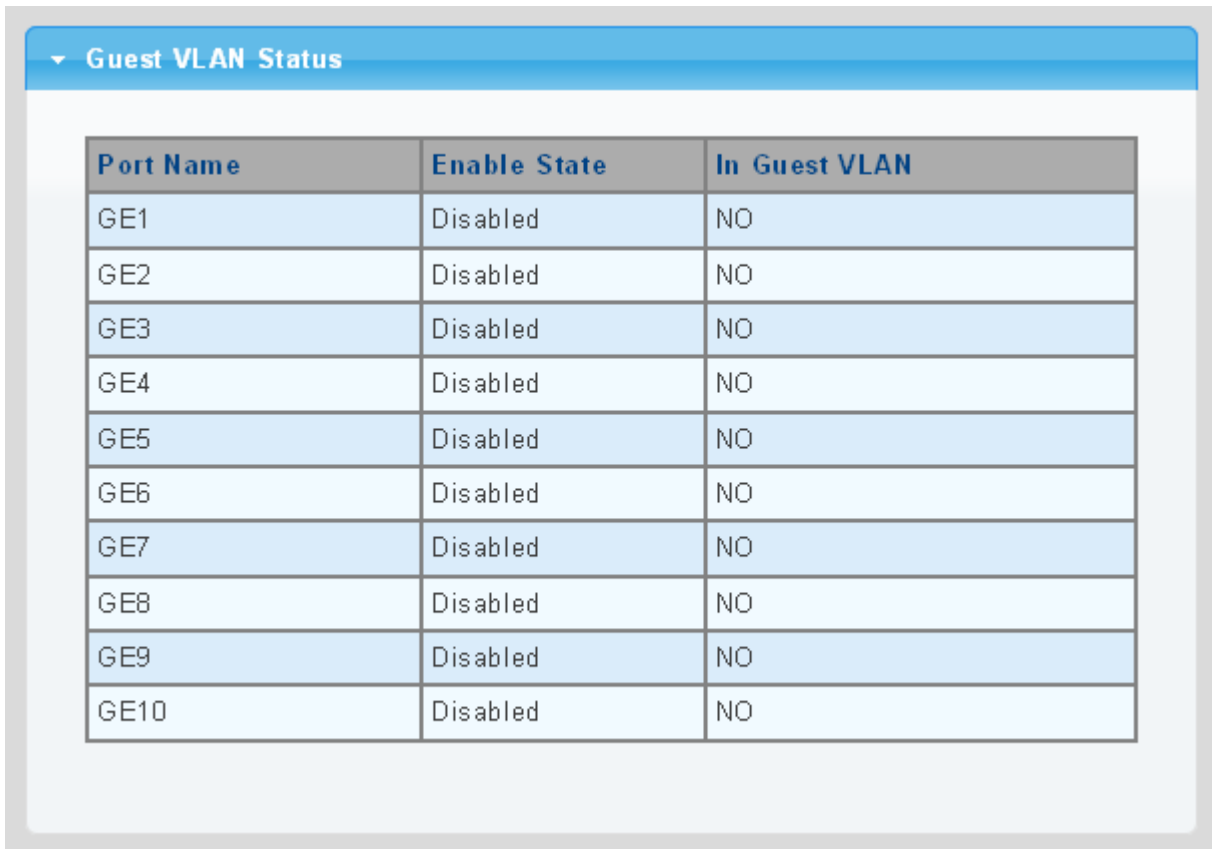

| Guest VLAN Status | | |
|-------------------|--------------|---------------|
| Port Name | Enable State | In Guest VLAN |
| GE1 | Disabled | NO |
| GE2 | Disabled | NO |
| GE3 | Disabled | NO |
| GE4 | Disabled | NO |
| GE5 | Disabled | NO |
| GE6 | Disabled | NO |
| GE7 | Disabled | NO |
| GE8 | Disabled | NO |
| GE9 | Disabled | NO |
| GE10 | Disabled | NO |

Figure 4-9-8 Guest VLAN Status Page Screenshot

The page includes the following fields:

| Object | Description |
|------------------------|--|
| • Port Name | The switch port number of the logical port |
| • Enable State | Display the current state |
| • In Guest VLAN | Display the current guest VLAN |

4.9.1.5 Authenticated Host

The Authenticated Host Table screen in [Figure 4-9-9](#) appears.



Figure 4-9-9 Authenticated Host Table Page Screenshot

The page includes the following fields:

| Object | Description |
|-------------------------|---|
| • User Name | Display the current user name |
| • Port | Display the current port number |
| • Session Time | Display the current session time |
| • Authentication Method | Display the current authentication method |
| • MAC Address | Display the current MAC address |

4.9.2 RADIUS Server

This page is to configure the RADIUS server connection session parameters. The RADIUS Settings screens in [Figure 4-9-10](#), [Figure 4-9-11](#) & [Figure 4-9-12](#) appears.

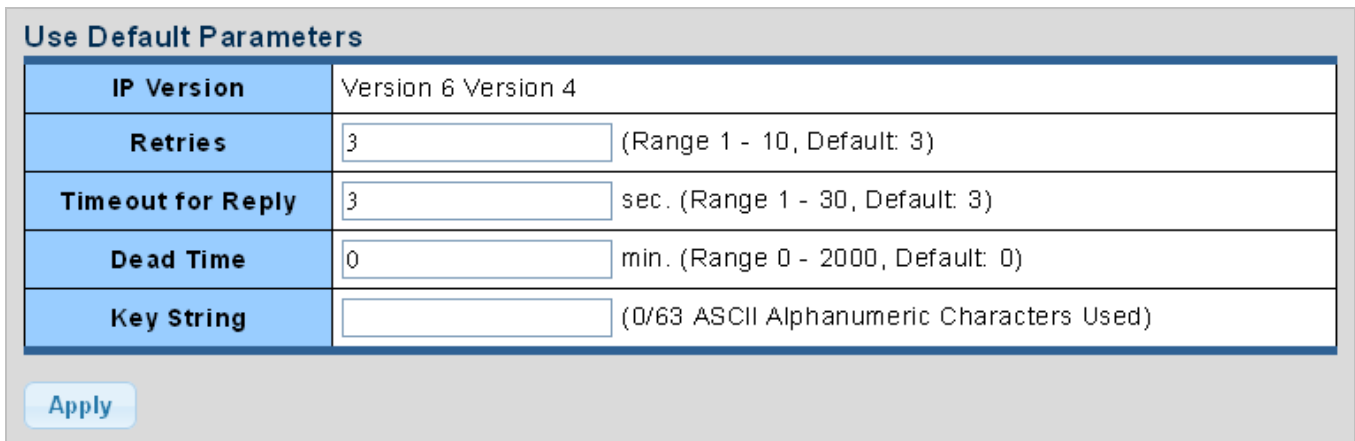

Figure 4-9-10 Use Default Parameters Page Screenshot

The page includes the following fields:

| Object | Description |
|---|---|
| <ul style="list-style-type: none"> Retries | Timeout is the number of seconds, in the range 1 to 10, to wait for a reply from a RADIUS server before retransmitting the request. |
| <ul style="list-style-type: none"> Timeout for Reply | Retransmit is the number of times, in the range 1 to 30, a RADIUS request is retransmitted to a server that is not responding. If the server has not responded after the last retransmit it is considered to be dead. |
| <ul style="list-style-type: none"> Dead Time | <p>The Dead Time, which can be set to a number between 0 and 3600 seconds, is the period during which the switch will not send new requests to a server that has failed to respond to a previous request. This will stop the switch from continually trying to contact a server that it has already determined as dead.</p> <p>Setting the Dead Time to a value greater than 0 (zero) will enable this feature, but only if more than one server has been configured.</p> |
| <ul style="list-style-type: none"> Key String | The secret key - up to 63 characters long - shared between the RADIUS server and the switch. |

Buttons

Apply: Click to apply changes.

New Radius Server

| | |
|----------------------------|---|
| Server Definition | <input checked="" type="radio"/> By IP address <input type="radio"/> By name |
| Server IP | <input type="text"/> |
| Authentication Port | <input type="text" value="1812"/> (0 - 65535) |
| Acct Port | <input type="text" value="1813"/> (0 - 65535) |
| Key String | <input checked="" type="checkbox"/> Use Default <input type="text"/> |
| Timeout for Reply | <input checked="" type="checkbox"/> Use Default <input type="text"/> (1-30) secs |
| Retries | <input checked="" type="checkbox"/> Use Default <input type="text"/> (1 - 10) |
| Server Priority | <input type="text" value="1"/> (0 - 65535) |
| Dead Time | <input type="text" value="0"/> (0 - 2000) |
| Usage Type | <input type="radio"/> Login <input type="radio"/> 802.1X <input checked="" type="radio"/> All |

Add

Figure 4-9-11 New RADIUS Server Page Screenshot

The page includes the following fields:

| Object | Description |
|------------------------------|--|
| • Server Definition | Set the server definition |
| • Server IP | Address of the RADIUS server IP/name |
| • Authentication Port | The UDP port to use on the RADIUS Authentication Server. If the port is set to 0 (zero), the default port (1812) is used on the RADIUS Authentication Server. |
| • Acct Port | The UDP port to use on the RADIUS Accounting Server. If the port is set to 0 (zero), the default port (1813) is used on the RADIUS Accounting Server. |
| • Key String | The shared key - shared between the RADIUS Authentication Server and the switch. |
| • Timeout for Reply | <p>The Timeout, which can be set to a number between 1 and 30 seconds, is the maximum time to wait for a reply from a server. If the server does not reply within this timeframe, we will consider it to be dead and continue with the next enabled server (if any).</p> <p>RADIUS servers are using the UDP protocol, which is unreliable by design. In order to cope with lost frames, the timeout interval is divided into 3 subintervals of equal length. If a reply is not received within the subinterval, the request is transmitted again. This algorithm causes the RADIUS server to be queried up to 3 times before it is considered to be dead.</p> |
| • Retries | Timeout is the number of seconds, in the range 1 to 10, to wait for a reply from a RADIUS server before retransmitting the request. |
| • Server Priority | Set the server priority |
| • Dead Time | <p>The Dead Time, which can be set to a number between 0 and 3600 seconds, is the period during which the switch will not send new requests to a server that has failed to respond to a previous request. This will stop the switch from continually trying to contact a server that it has already determined as dead.</p> <p>Setting the Dead Time to a value greater than 0 (zero) will enable this feature, but only if more than one server has been configured.</p> |
| • Usage Type | <p>Set the usage type. The following modes are available:</p> <ul style="list-style-type: none"> ■ Login ■ 802.1X ■ All |

Buttons

: Click to add RADIUS server setting.

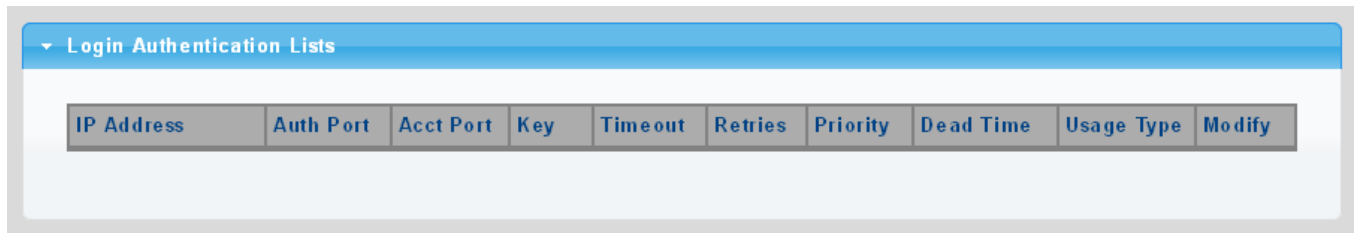



Figure 4-9-12 Login Authentication List Page Screenshot

The page includes the following fields:

| Object | Description |
|---------------------|---|
| • IP Address | Display the current IP address |
| • Auth Port | Display the current auth port |
| • Acct Port | Display the current acct port |
| • Key | Display the current key |
| • Timeout | Display the current timeout |
| • Retries | Display the current retry times |
| • Priority | Display the current priority |
| • Dead Time | Display the current dead time |
| • Usage Type | Display the current usage type |
| • Modify | <p>Click  to edit login authentication list parameter.</p> <p>Click  to delete login authentication list entry.</p> |

4.9.3 TACACS+ Server

This page is to configure the RADIUS server connection session parameters. The RADIUS Settings screens in [Figure 4-9-13](#), [Figure 4-9-14](#) & [Figure 4-9-15](#) appear.

Use Default Parameters

| | |
|--------------------------|--|
| IP Version | Version 6 Version 4 |
| Key String | <input type="text"/> (0/63 ASCII Alphanumeric Characters Used) |
| Timeout for Reply | <input type="text" value="5"/> sec. (Range 1 - 30, Default: 5) |

Figure 4-9-13 Guest VLAN Setting Page Screenshot

The page includes the following fields:

| Object | Description |
|--|--|
| <ul style="list-style-type: none"> • Key String | The secret key with up to 63 characters long is shared between the TACACS+ server and the switch. |
| <ul style="list-style-type: none"> • Timeout for Reply | Retransmit is the number of times, in the range 1 to 30, a TACACS+ request is retransmitted to a server that is not responding. If the server has not responded after the last retransmit it is considered to be dead. |

Buttons

: Click to apply changes.

New Tacacs+ Server

| | |
|--------------------------|--|
| Server Definition | <input checked="" type="radio"/> By IP address <input type="radio"/> By name |
| Server IP | <input type="text"/> |
| Server Port | <input type="text" value="49"/> (0 - 65535) |
| Server Key | <input checked="" type="checkbox"/> Use Default <input type="text"/> |
| Server Timeout | <input checked="" type="checkbox"/> Use Default <input type="text"/> (1-30) secs |
| Server Priority | <input type="text" value="1"/> (0 - 65535) |

Figure 4-9-14 New RADIUS Server Page Screenshot

The page includes the following fields:

| Object | Description |
|----------------------------|---|
| • Server Definition | Set the server definition |
| • Server IP | Address of the TACACS+ server IP/name |
| • Server Port | Network (TCP) port of TACACS+ server used for authentication messages. (Range: 1-65535; Default: 49) |
| • Server Key | The key is shared between the TACACS+ Authentication Server and the switch. |
| • Server Timeout | The number of seconds the switch waits for a reply from the server before it resends the request. |
| • Server Priority | Set the server priority |

Buttons

: Click to add RADIUS server setting.

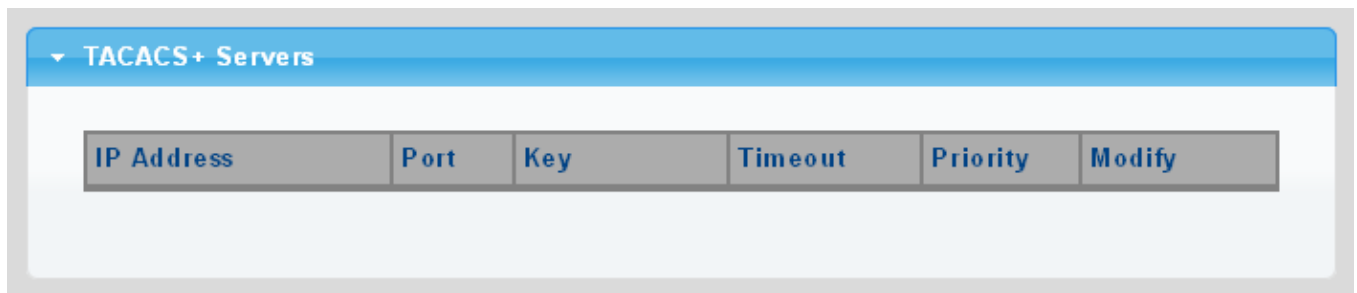



Figure 4-9-15 Login Authentication List Page Screenshot

The page includes the following fields:

| Object | Description |
|---------------------|---------------------------------|
| • IP Address | Display the current IP address |
| • Port | Display the current port |
| • Key | Display the current key |
| • Timeout | Display the current timeout |
| • Retries | Display the current retry times |
| • Priority | Display the current priority |

| | |
|---|--|
| <ul style="list-style-type: none">• Modify | Click  to edit login authentication list parameter Click  to delete login authentication list entry |
|---|--|

4.9.4 AAA

Authentication, authorization, and accounting (AAA) provides a framework for configuring access control on the LRP Managed Switch. The three security functions can be summarized as follows:

- **Authentication** — Identifies users that request access to the network.
- **Authorization** — Determines if users can access specific services.
- **Accounting** — Provides reports, auditing, and billing for services that users have accessed on the network.

The AAA functions require the use of configured RADIUS or TACACS+ servers in the network. The security servers can be defined as sequential groups that are then applied as a method for controlling user access to specified services. For example, when the switch attempts to authenticate a user, a request is sent to the first server in the defined group, if there is no response the second server will be tried, and so on. If at any point a pass or fail is returned, the process stops.

The LRP Managed Switch supports the following AAA features:

- Accounting for **IEEE 802.1X authenticated users** that access the network through the LRP Managed Switch.
- Accounting for users that access **management interfaces** on the LRP Managed Switch through the console and Telnet.
- Accounting for **commands** that users enter at specific CLI privilege levels. Authorization of users that access management interfaces on the LRP Managed Switch through the console and Telnet.

To configure AAA on the LRP Managed Switch, you need to follow this general process:

1. Configure RADIUS and TACACS+ server access parameters. See “[Configuring Local/Remote Logon Authentication](#)”.
2. Define RADIUS and TACACS+ server groups to support the accounting and authorization of services.
3. Define a method name for each service to which you want to apply accounting or authorization and specify the RADIUS or TACACS+ server groups to use. Apply the method names to port or line interfaces.



This guide assumes that RADIUS and TACACS+ servers have already been configured to support AAA. The configuration of RADIUS and TACACS+ server software is beyond the scope of this guide. Refer to the documentation provided with the RADIUS or TACACS+ server software.

4.9.4.1 Login List

This page is to login list parameters. The authentication list screens in [Figure 4-9-17](#) & [Figure 4-9-18](#) appear.

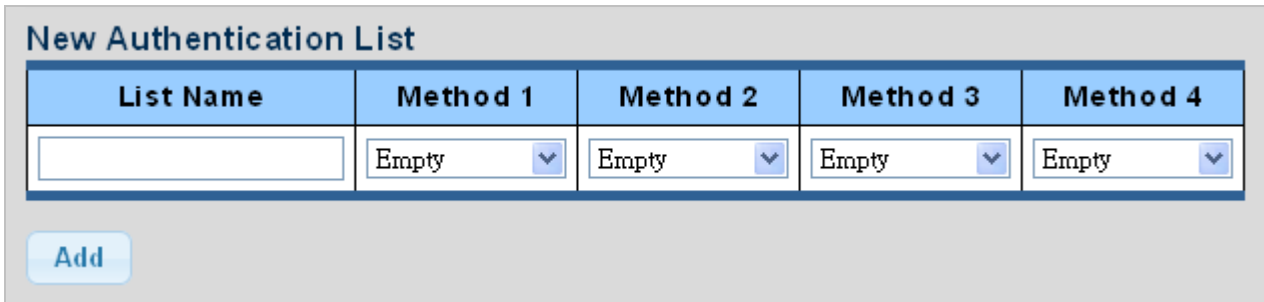

| List Name | Method 1 | Method 2 | Method 3 | Method 4 |
|----------------------|----------|----------|----------|----------|
| <input type="text"/> | Empty | Empty | Empty | Empty |

Figure 4-9-17 New Authentication List Screenshot

The page includes the following fields:

| Object | Description |
|--|--|
| <ul style="list-style-type: none"> List Name | Defines a name for the authentication list |
| <ul style="list-style-type: none"> Method 1-4 | Set the login authentication method: Empty / None / Local / TACACS+ / RADIUS / Enable |

Buttons

: Click to add authentication list.

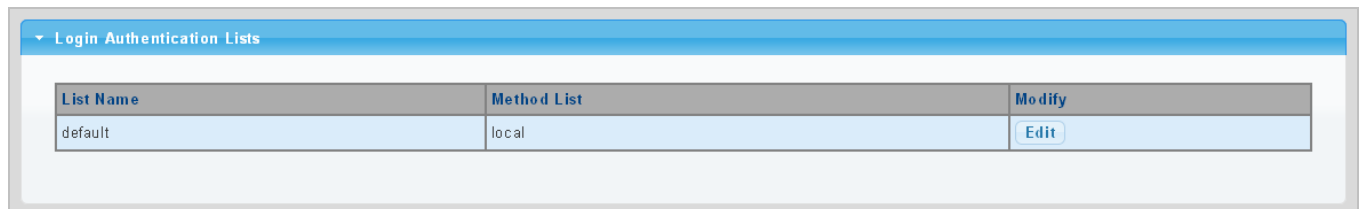

| List Name | Method List | Modify |
|-----------|-------------|-------------------------------------|
| default | local | <input type="button" value="Edit"/> |

Figure 4-9-18 Login Authentication List Screenshot

The page includes the following fields:

| Object | Description |
|---|--|
| <ul style="list-style-type: none"> List Name | Display the current list name |
| <ul style="list-style-type: none"> Method List | Display the current method list |
| <ul style="list-style-type: none"> Modify | Click <input type="button" value="Edit"/> to edit login authentication list parameter Click <input type="button" value="Delete"/> to delete login authentication list entry |

4.9.4.2 Enable List

This page is to login list parameters. The authentication list screens in [Figure 4-9-19](#) & [Figure 4-9-20](#) appear.

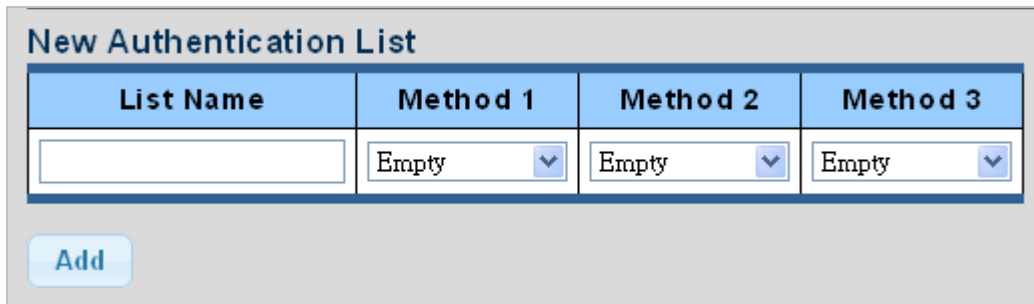

| List Name | Method 1 | Method 2 | Method 3 |
|----------------------|--|--|--|
| <input type="text"/> | Empty <input type="button" value="v"/> | Empty <input type="button" value="v"/> | Empty <input type="button" value="v"/> |

Figure 4-9-19 New Authentication List Screenshot

The page includes the following fields:

| Object | Description |
|--|--|
| <ul style="list-style-type: none"> List Name | Defines a name for the authentication list |
| <ul style="list-style-type: none"> Method 1-3 | Set the login authentication method: Empty / None / Enable / TACACS+ / RADIUS |

Buttons

: Click to add authentication list.

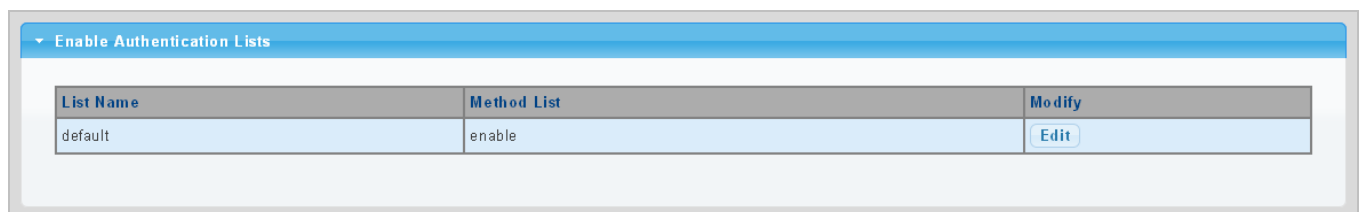

| List Name | Method List | Modify |
|-----------|-------------|-------------------------------------|
| default | enable | <input type="button" value="Edit"/> |

Figure 4-9-20 Login Authentication List Screenshot

The page includes the following fields:

| Object | Description |
|---|--|
| <ul style="list-style-type: none"> List Name | Display the current list name |
| <ul style="list-style-type: none"> Method List | Display the current method list |
| <ul style="list-style-type: none"> Modify | Click <input type="button" value="Edit"/> to edit login authentication list parameter Click <input type="button" value="Delete"/> to delete login authentication list entry |

4.9.5 Access

This section is to control the access of the LRP Managed Switch, including the different access methods – Telnet, SSH, HTTP and HTTPS.

4.9.5.1 Telnet

The Telnet Settings and Information screens in [Figure 4-9-21](#) & [Figure 4-9-22](#) appear.

Telnet Settings

| | |
|-----------------------------------|---|
| Telnet Service | Disabled <input type="button" value="v"/> |
| Login Authentication List | default <input type="button" value="v"/> |
| Enable Authentication List | default <input type="button" value="v"/> |
| Session Timeout | <input type="text" value="10"/> (0-65535) minutes |
| Password Retry Count | <input type="text" value="3"/> (0-120) |
| Silent Time | <input type="text" value="0"/> (0-65535) seconds |

Figure 4-9-21 Telnet Settings Page Screenshot

The page includes the following fields:

| Object | Description |
|-------------------------------------|--|
| • Telnet Service | Disable or enable Telnet service |
| • Login Authentication List | Select login authentication list from this drop-down list |
| • Enable Authentication List | Select enable authentication list from this drop-down list |
| • Session Timeout | Set the session timeout value |
| • Password Retry Count | Set the password retry count value |
| • Silent Time | Set the silent time value |

Buttons

: Click to apply changes

: Click to disconnect Telnet communication

| Telnet Information | |
|-------------------------------|-------------------|
| Information Name | Information Value |
| Telnet Service | Disabled |
| Login Authentication List | default |
| Enable Authentication List | default |
| Session Timeout | 10 |
| Password Retry Count | 3 |
| Silent Time | 0 |
| Current Telnet Sessions Count | 0 |

Figure 4-9-21 Telnet Information Page Screenshot

The page includes the following fields:

| Object | Description |
|---------------------------------------|--|
| • Telnet Service | Display the current Telnet service |
| • Login Authentication List | Display the current login authentication list |
| • Enable Authentication List | Display the current enable authentication list |
| • Session Timeout | Display the current session timeout |
| • Password Retry Count | Display the current password retry count |
| • Silent Time | Display the current silent time |
| • Current Telnet Session Count | Display the current Telnet session count |

4.9.5.2 SSH

Configure SSH on this page. This page shows the Port Security status. Port Security is a module with no direct configuration. Configuration comes indirectly from other modules -- the user modules. When a user module has enabled port security on a port, the port is set up for software-based learning. In this mode, frames from unknown MAC addresses are passed on to the port security module, which in turn asks all user modules whether to allow this new MAC address to forward or block it. For a MAC address to be set in the forwarding state, all enabled user modules must unanimously agree on allowing the MAC address to forward. If only one chooses to block it, it will be blocked until that user module decides otherwise.

The SSH Settings and Information screens in [Figure 4-9-23](#) & [Figure 4-9-24](#) appear.

SSH Settings

| | |
|-----------------------------------|---|
| SSH Service | Disabled <input type="button" value="v"/> |
| Login Authentication List | default <input type="button" value="v"/> |
| Enable Authentication List | default <input type="button" value="v"/> |
| Session Timeout | <input type="text" value="10"/> (0-65535) minutes |
| Password Retry Count | <input type="text" value="3"/> (0-120) minutes |
| Silent Time | <input type="text" value="0"/> (0-65535) seconds |

Figure 4-9-23 SSH Settings Page Screenshot

The page includes the following fields:

| Object | Description |
|-------------------------------------|--|
| • SSH Service | Disable or enable SSH service |
| • Login Authentication List | Select login authentication list from this drop-down list |
| • Enable Authentication List | Select enable authentication list from this drop-down list |
| • Session Timeout | Set the session timeout value |
| • Password Retry Count | Set the password retry count value |
| • Silent Time | Set the silent time value |

Buttons

: Click to apply changes.

: Click to disconnect Telnet communication.

| SSH Information | |
|----------------------------|-------------------|
| Information Name | Information Value |
| SSH Service | Disabled |
| Login Authentication List | default |
| Enable Authentication List | default |
| Session Timeout | 10 |
| Password Retry Count | 3 |
| Silent Time | 0 |
| Current SSH Sessions Count | 0 |

Figure 4-9-24 SSH Information Page Screenshot

The page includes the following fields:

| Object | Description |
|------------------------------|--|
| • SSH Service | Display the current SSH service |
| • Login Authentication List | Display the current login authentication list |
| • Enable Authentication List | Display the current enable authentication list |
| • Session Timeout | Display the current session timeout |
| • Password Retry Count | Display the current password retry count |
| • Silent Time | Display the current silent time |
| • Current SSH Session Count | Display the current SSH session count |

4.9.5.3 HTTP

The HTTP Settings and Information screens in [Figure 4-9-25](#) & [Figure 4-9-26](#) appear.

| HTTP Settings | |
|---------------------------|---|
| HTTP Service | <input checked="" type="radio"/> Enabled <input type="radio"/> Disabled |
| Login Authentication List | default <input type="button" value="v"/> |
| Session Timeout | 10 (0-86400) minutes |

Figure 4-9-25 HTTP Settings Page Screenshot

The page includes the following fields:

| Object | Description |
|-----------------------------|---|
| • HTTP Service | Disable or enable HTTP service |
| • Login Authentication List | Select login authentication list from this drop-down list |
| • Session Timeout | Set the session timeout value |

Buttons

: Click to apply changes.

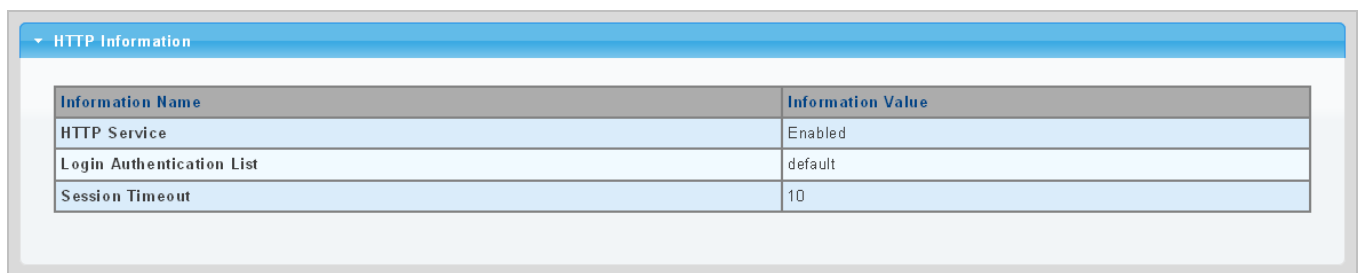

Figure 4-9-26 HTTP Information Page Screenshot

The page includes the following fields:

| Object | Description |
|-----------------------------|---|
| • HTTP Service | Display the current HTTP service |
| • Login Authentication List | Display the current login authentication list |
| • Session Timeout | Display the current session timeout |

4.9.5.4 HTTPS

The HTTPS Settings and Information screens in [Figure 4-9-27](#) & [Figure 4-9-28](#) appear.

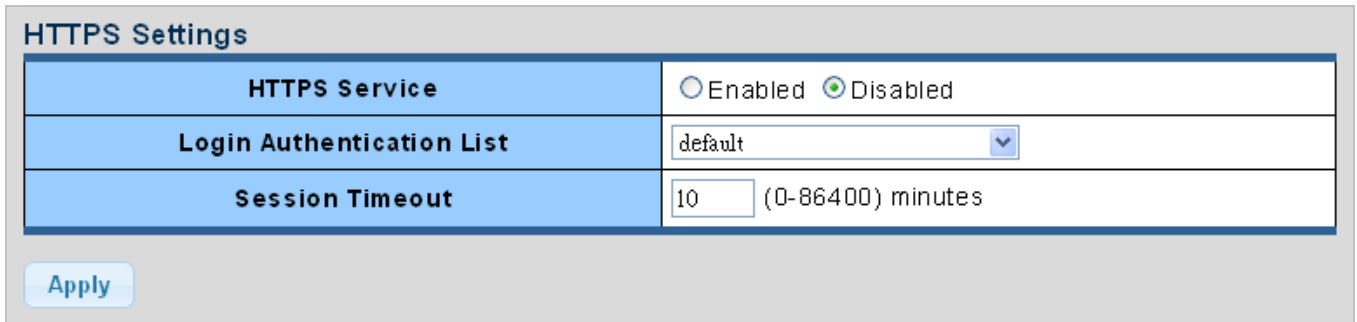

| HTTPS Settings | |
|---------------------------|---|
| HTTPS Service | <input type="radio"/> Enabled <input checked="" type="radio"/> Disabled |
| Login Authentication List | default |
| Session Timeout | 10 (0-86400) minutes |

Apply

Figure 4-9-27 HTTPS Settings Page Screenshot

The page includes the following fields:

| Object | Description |
|-----------------------------|---|
| • HTTPS Service | Disable or enable HTTPS service |
| • Login Authentication List | Select login authentication list from this drop-down list |
| • Session Timeout | Set the session timeout value |

Buttons

: Click to apply changes.

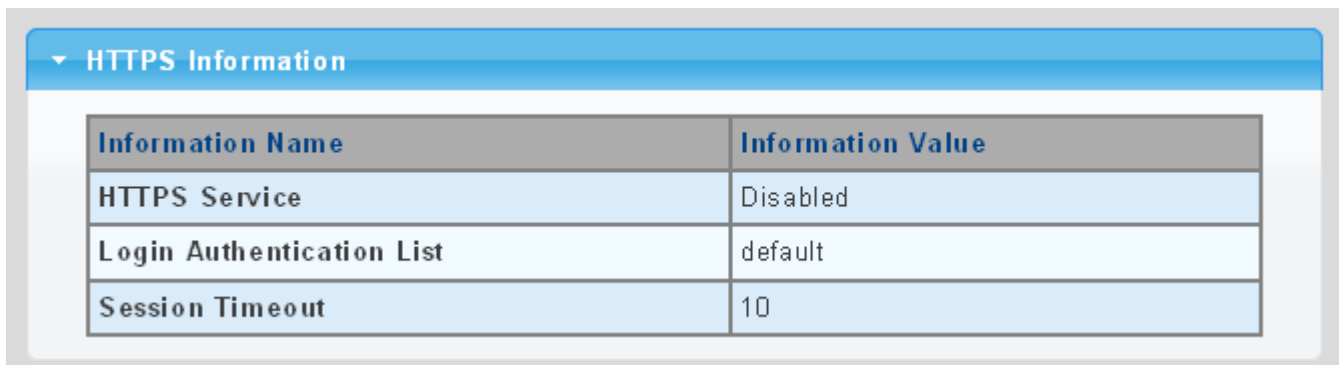

| HTTPS Information | |
|---------------------------|-------------------|
| Information Name | Information Value |
| HTTPS Service | Disabled |
| Login Authentication List | default |
| Session Timeout | 10 |

Figure 4-9-28 HTTPS Information Page Screenshot

The page includes the following fields:

| Object | Description |
|-----------------------------|---|
| • HTTPS Service | Display the current HTTPS service |
| • Login Authentication List | Display the current login authentication list |
| • Session Timeout | Display the current session timeout |

4.9.6 Management Access Method

4.9.6.1 Profile Rules

The Profile Rule Table Setting and Table screens in [Figure 4-9-29](#) & [Figure 4-9-30](#) appear.

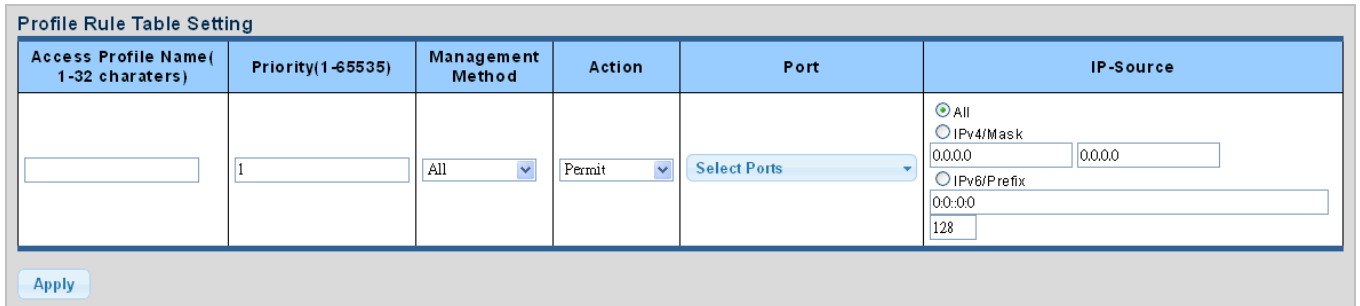

| Access Profile Name(1-32 characters) | Priority(1-65535) | Management Method | Action | Port | IP-Source |
|--------------------------------------|--------------------------------|----------------------------------|-------------------------------------|---|---|
| <input type="text"/> | <input type="text" value="1"/> | <input type="text" value="All"/> | <input type="text" value="Permit"/> | <input type="text" value="Select Ports"/> | <input checked="" type="radio"/> All <input type="radio"/> IPv4/Mask <input type="radio"/> IPv6/Prefix |
| | | | | | <input type="text" value="0.0.0.0"/> <input type="text" value="0.0.0.0"/> <input type="text" value="0.0:00"/> <input type="text" value="128"/> |

Figure 4-9-29 Profile Rule Table Setting Page Screenshot

The page includes the following fields:

| Object | Description |
|--|--|
| <ul style="list-style-type: none"> • Access Profile Name (1-32 characters) | Indicates the access profile name |
| <ul style="list-style-type: none"> • Priority (1-65535) | Set priority. The allowed value is from 1 to 65535 |
| <ul style="list-style-type: none"> • Management Method | Indicates the host can access the switch from HTTP/HTTPs/telnet/SSH/SNMP/All interface that the host IP address matched the entry. |
| <ul style="list-style-type: none"> • Action | An IP address can contain any combination of permit or deny rules. (Default: Permit rules)Sets the access mode of the profile; either permit or deny . |
| <ul style="list-style-type: none"> • Port | Select port from this drop-down list |
| <ul style="list-style-type: none"> • IP-Source | Indicates the IP address for the access management entry |

Buttons



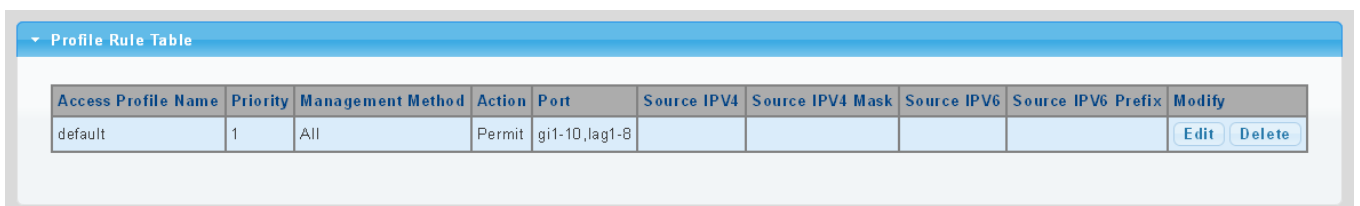

: Click to apply changes.



| Access Profile Name | Priority | Management Method | Action | Port | Source IPv4 | Source IPv4 Mask | Source IPv6 | Source IPv6 Prefix | Modify |
|---------------------|----------|-------------------|--------|---------------|-------------|------------------|-------------|--------------------|---|
| default | 1 | All | Permit | gi1-10,lag1-8 | | | | | <input type="button" value="Edit"/> <input type="button" value="Delete"/> |

Figure 4-9-30 Profile Rule Table Page Screenshot

The page includes the following fields:

| Object | Description |
|-----------------------|--|
| • Access Profile Name | Display the current access profile name |
| • Priority | Display the current priority |
| • Management Method | Display the current management method |
| • Action | Display the current action |
| • Port | Display the current port list |
| • Source IPv4 | Display the current source IPv4 address |
| • Source IPv4 Mask | Display the current source IPv4 mask |
| • Source IPv6 | Display the current source IPv6 address |
| • Source IPv6 Prefix | Display the current source IPv6 prefix |
| • Modify | Click  to edit profile rule parameter Click  to delete profile rule entry |

4.9.6.2 Access Rules

The access profile screens in [Figure 4-9-31](#) & [Figure 4-9-32](#) appear.

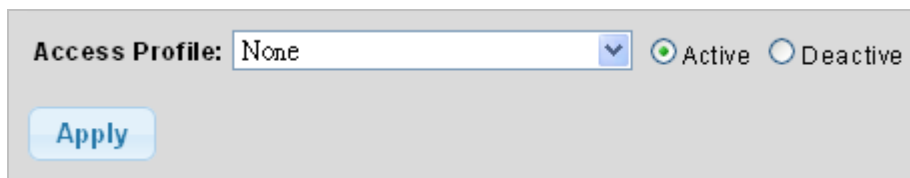

Figure 4-9-31 Access Profile Page Screenshot

The page includes the following fields:

| Object | Description |
|------------------|--|
| • Access Profile | Select access profile from this drop-down list |

Buttons

Apply: Click to apply changes.

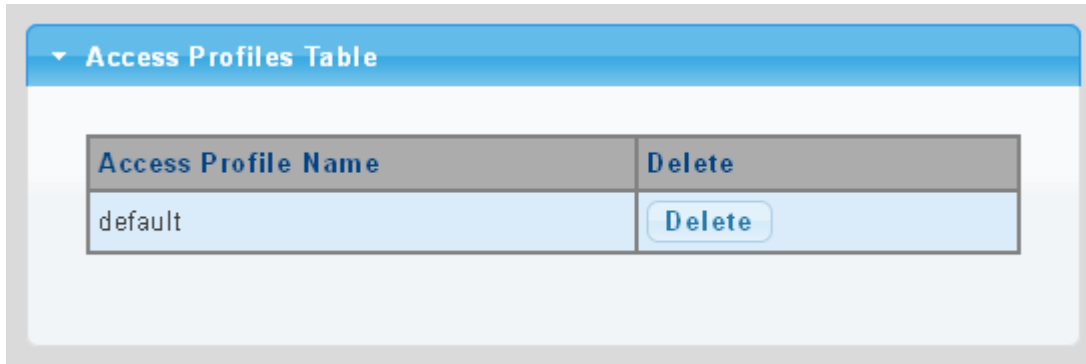

Figure 4-9-32 Access Profile Table Page Screenshot

The page includes the following fields:

| Object | Description |
|---|--|
| <ul style="list-style-type: none"> • Access Profile | Display the current access profile |
| <ul style="list-style-type: none"> • Delete | Click Delete to delete access profile entry |

4.9.7 DHCP Snooping

4.9.7.1 DHCP Snooping Overview

The addresses assigned to DHCP clients on unsecure ports can be carefully controlled using the dynamic bindings registered with DHCP Snooping. DHCP snooping allows a switch to protect a network from rogue DHCP servers or other devices which send port-related information to a DHCP server. This information can be useful in tracking an IP address back to a physical port.

DHCP Snooping Overview

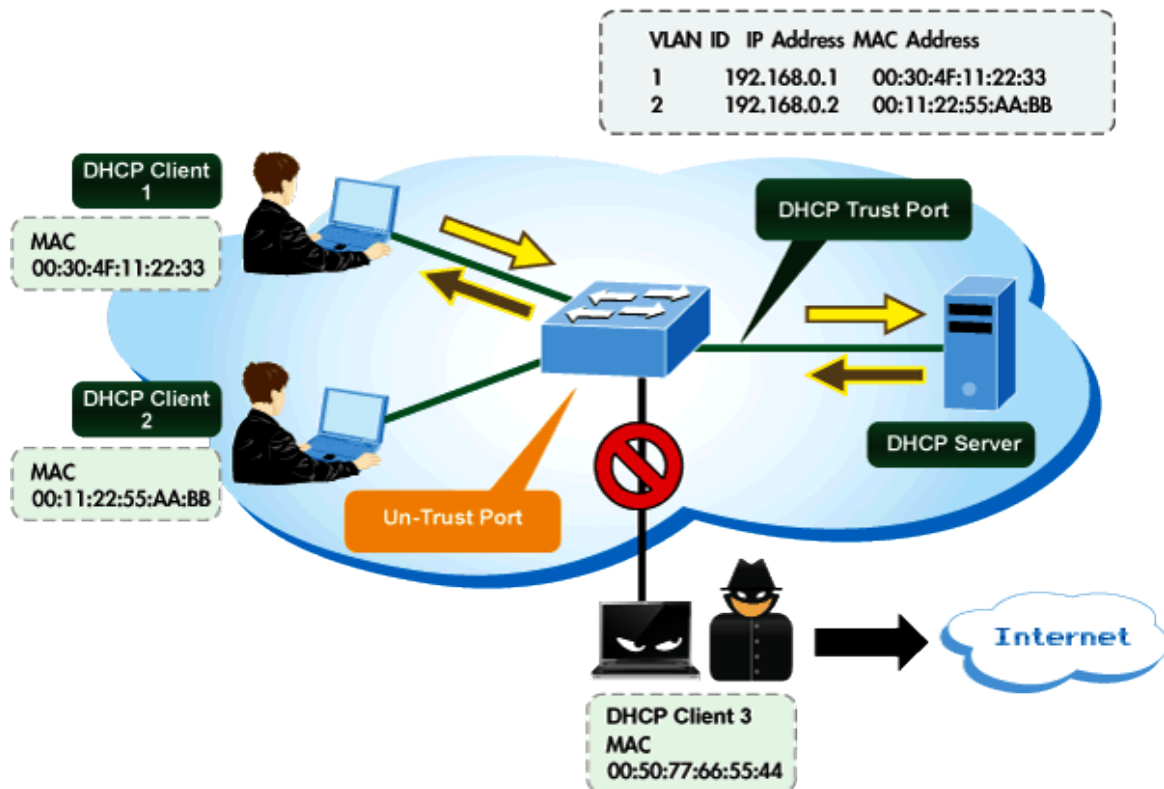

Command Usage

- Network traffic may be disrupted when malicious DHCP messages are received from an outside source. **DHCP snooping is used to filter DHCP messages received on a non-secure interface from outside the network or firewall.** When DHCP snooping is enabled globally and enabled on a VLAN interface, **DHCP messages received on an untrusted interface from a device not listed in the DHCP snooping table will be dropped.**
- Table entries are only learned for trusted interfaces. An entry is added or removed dynamically to the DHCP snooping table when a client receives or releases an IP address from a DHCP server. Each entry includes a MAC address, IP address, lease time, VLAN identifier, and port identifier.
- When DHCP snooping is enabled, DHCP messages entering an untrusted interface are filtered based upon dynamic entries learned via DHCP snooping.
- Filtering rules are implemented as follows:

- If the global DHCP snooping is disabled, all DHCP packets are forwarded.
 - If DHCP snooping is enabled globally, and also enabled on the VLAN where the DHCP packet is received, all DHCP packets are forwarded for a trusted port. If the received packet is a DHCP ACK message, a dynamic DHCP snooping entry is also added to the binding table.
 - If DHCP snooping is enabled globally, and also enabled on the VLAN where the DHCP packet is received, but the port is not trusted, it is processed as follows:
 - If the DHCP packet is a reply packet from a DHCP server (including OFFER, ACK or NAK messages), the packet is dropped.
 - If the DHCP packet is from a client, such as a DECLINE or RELEASE message, the switch forwards the packet only if the corresponding entry is found in the binding table.
 - If the DHCP packet is from a client, such as a DISCOVER, REQUEST, INFORM, DECLINE or RELEASE message, the packet is forwarded if MAC address verification is disabled. However, if MAC address verification is enabled, then the packet will only be forwarded if the client's hardware address stored in the DHCP packet is the same as the source MAC address in the Ethernet header.
 - If the DHCP packet is not a recognizable type, it is dropped.
- If a DHCP packet from a client passes the filtering criteria above, it will only be forwarded to trusted ports in the same VLAN.
 - If a DHCP packet is from server is received on a trusted port, it will be forwarded to both trusted and untrusted ports in the same VLAN.
 - If the DHCP snooping is globally disabled, all dynamic bindings are removed from the binding table.
 - Additional considerations when the switch itself is a DHCP client – The port(s) through which the switch submits a client request to the DHCP server must be configured as trusted. Note that the switch will not add a dynamic entry for itself to the binding table when it receives an ACK message from a DHCP server. Also, when the switch sends out DHCP client packets for itself, no filtering takes place. However, when the switch receives any messages from a DHCP server, any packets received from untrusted ports are dropped.

4.9.7.2 Global Setting

DHCP Snooping is used to block intruder on the untrusted ports of switch when it tries to intervene by injecting a bogus DHCP reply packet to a legitimate conversation between the DHCP client and server. Configure DHCP Snooping on this page. The DHCP Snooping Setting and Information screens in [Figure 4-9-33](#) & [Figure 4-9-34](#) appear.

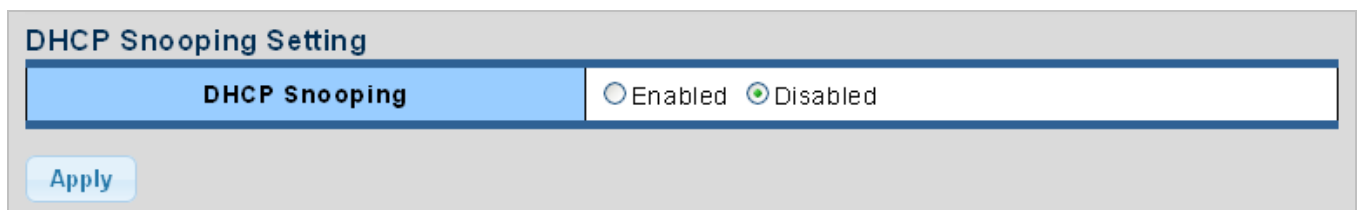



Figure 4-9-33 DHCP Snooping Setting Page Screenshot

The page includes the following fields:

| Object | Description |
|--|---|
| <ul style="list-style-type: none"> • DHCP Snooping | <p>Indicates the DHCP snooping mode operation. Possible modes are:</p> <ul style="list-style-type: none"> ■ Enabled: Enable DHCP snooping mode operation. When DHCP snooping mode operation is enabled, the request DHCP messages will be forwarded to trusted ports and only allowed reply packets from trusted ports. ■ Disabled: Disable DHCP snooping mode operation. |

Buttons

: Click to apply changes.

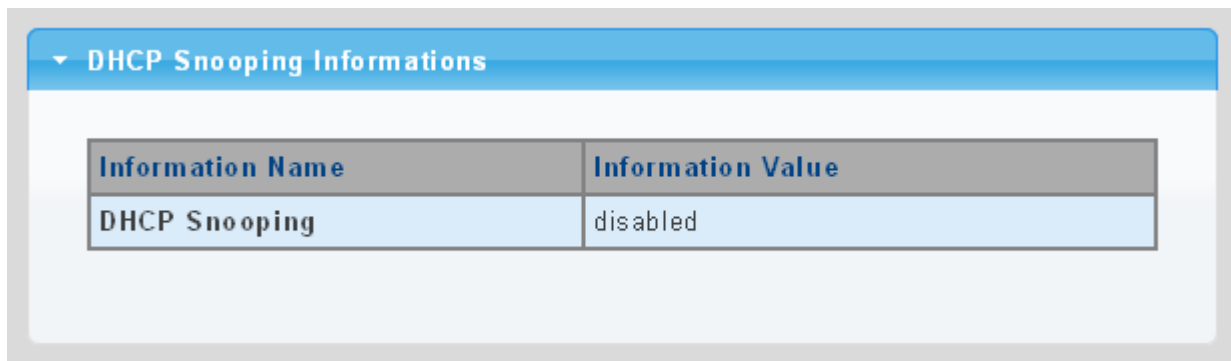

Figure 4-9-34 DHCP Snooping Information Page Screenshot

The page includes the following fields:

| Object | Description |
|--|--|
| <ul style="list-style-type: none"> • DHCP Snooping | Display the current DHCP snooping status |

4.9.7.3 VLAN Setting

Command Usage

- When DHCP snooping is enabled globally on the switch, and enabled on the specified VLAN, DHCP packet filtering will be performed on any untrusted ports within the VLAN.
- When the DHCP snooping is globally disabled, DHCP snooping can still be configured for specific VLANs, but the changes will not take effect until DHCP snooping is globally re-enabled.
- When DHCP snooping is globally enabled, and DHCP snooping is then disabled on a VLAN, all dynamic bindings learned for this VLAN are removed from the binding table.

The DHCP Snooping VLAN Setting screens in [Figure 4-9-35](#) & [Figure 4-9-36](#) appear.

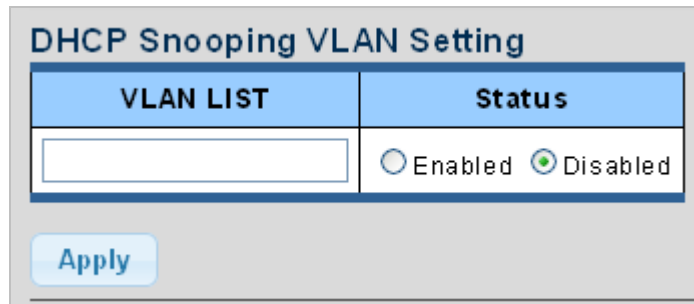



Figure 4-9-35 DHCP Snooping VLAN Setting Page Screenshot

The page includes the following fields:

| Object | Description |
|--|--|
| <ul style="list-style-type: none"> • VLAN List | Indicates the ID of this particular VLAN. |
| <ul style="list-style-type: none"> • Status | Indicates the DHCP snooping mode operation. Possible modes are: <ul style="list-style-type: none"> ■ Enabled: Enable DHCP snooping mode operation. When DHCP snooping mode operation is enabled, the request DHCP messages will be forwarded to trusted ports and only allowed reply packets from trusted ports. ■ Disabled: Disable DHCP snooping mode operation. |

Buttons

: Click to apply changes.

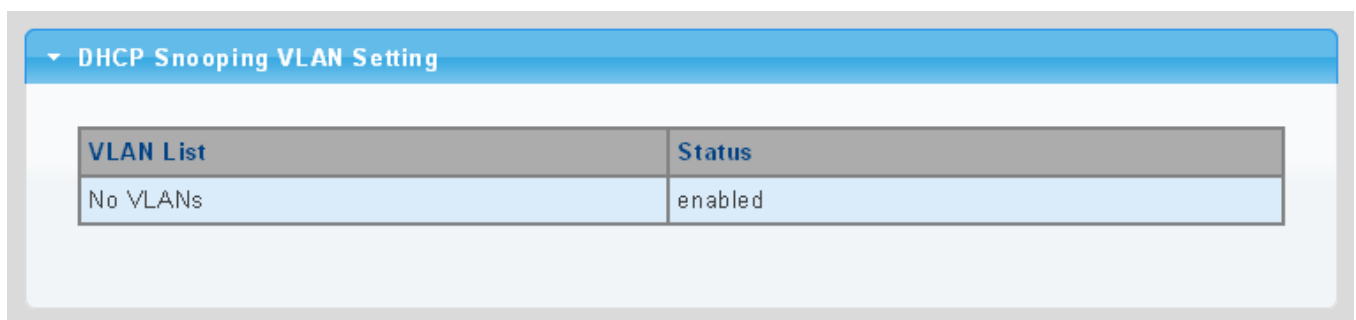

Figure 4-9-36 DHCP Snooping VLAN Setting Page Screenshot

The page includes the following fields:

| Object | Description |
|--|--|
| <ul style="list-style-type: none"> • VLAN List | Display the current VLAN list |
| <ul style="list-style-type: none"> • Status | Display the current DHCP snooping status |

4.9.7.4 Port Setting

Configures switch ports as trusted or untrusted.

Command Usage

- A trusted interface is an interface that is configured to receive only messages from within the network. An untrusted interface is an interface that is configured to receive messages from outside the network or firewall.
- When DHCP snooping is enabled both globally and on a VLAN, DHCP packet filtering will be performed on any untrusted ports within the VLAN.
- When an untrusted port is changed to a trusted port, all the dynamic DHCP snooping bindings associated with this port are removed.
- Set all ports connected to DHCP servers within the local network or firewall to trusted state. Set all other ports outside the local network or firewall to untrusted state.

The DHCP Snooping Port Setting screens in [Figure 4-9-37](#) & [Figure 4-9-38](#) appear.

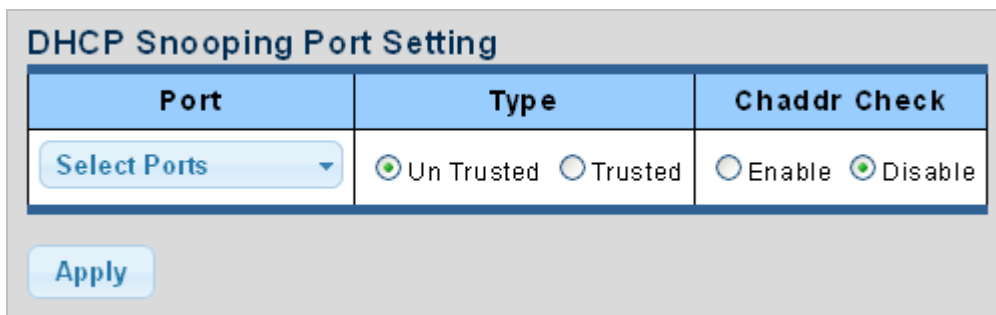

Figure 4-9-37 DHCP Snooping Port Setting Page Screenshot

The page includes the following fields:

| Object | Description |
|-----------------------|--|
| • Port | Select port from this drop-down list |
| • Type | Indicates the DHCP snooping port mode. Possible port modes are: <ul style="list-style-type: none"> ■ Trusted: Configures the port as trusted sources of the DHCP message. ■ Untrusted: Configures the port as untrusted sources of the DHCP message. |
| • Chaddr Check | Indicates that the Chaddr check function is enabled on selected port. Chaddr: Client hardware address. |

Buttons

: Click to apply changes.

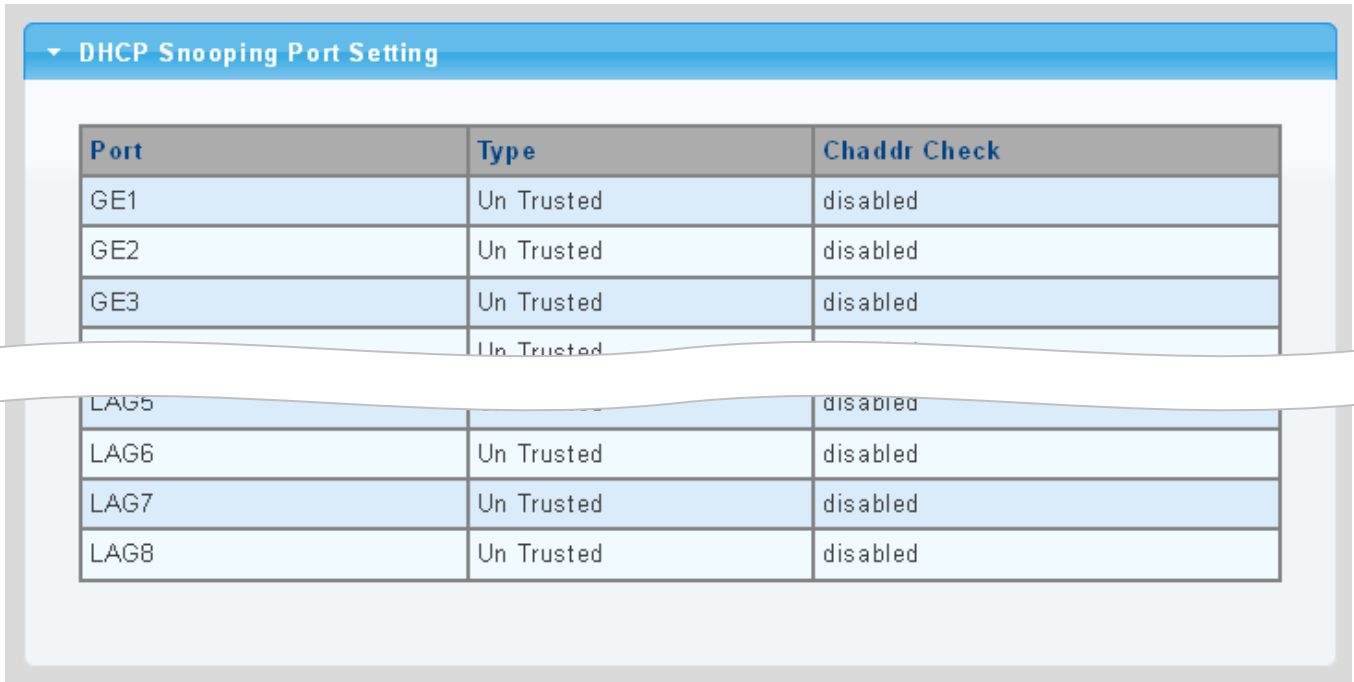

| Port | Type | Chaddr Check |
|------|------------|--------------|
| GE1 | Un Trusted | disabled |
| GE2 | Un Trusted | disabled |
| GE3 | Un Trusted | disabled |
| LAG5 | Un Trusted | disabled |
| LAG6 | Un Trusted | disabled |
| LAG7 | Un Trusted | disabled |
| LAG8 | Un Trusted | disabled |

Figure 4-9-38 DHCP Snooping Port Setting Page Screenshot

The page includes the following fields:

| Object | Description |
|----------------|--|
| • Port | The switch port number of the logical port |
| • Type | Display the current type |
| • Chaddr Check | Display the current chaddr check |

4.9.7.5 Statistics

The DHCP Snooping Statistics screen in [Figure 4-9-39](#) appears.

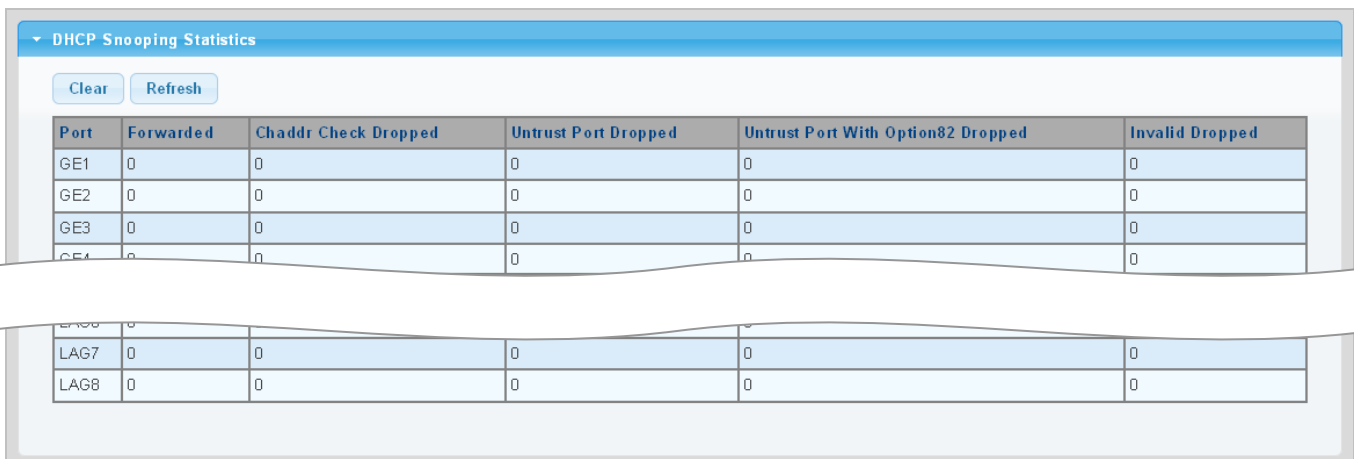

| Port | Forwarded | Chaddr Check Dropped | Untrust Port Dropped | Untrust Port With Option82 Dropped | Invalid Dropped |
|------|-----------|----------------------|----------------------|------------------------------------|-----------------|
| GE1 | 0 | 0 | 0 | 0 | 0 |
| GE2 | 0 | 0 | 0 | 0 | 0 |
| GE3 | 0 | 0 | 0 | 0 | 0 |
| LAG7 | 0 | 0 | 0 | 0 | 0 |
| LAG8 | 0 | 0 | 0 | 0 | 0 |

Figure 4-9-39 DHCP Snooping Statistics Page Screenshot

The page includes the following fields:

| Object | Description |
|--|--|
| • Port | The switch port number of the logical port |
| • Forwarded | Display the current forwarded |
| • Chaddr Check Dropped | Display the chaddr check dropped |
| • Untrusted Port Dropped | Display untrusted port dropped |
| • Untrusted Port with Option82 Dropped | Display untrusted port with option82 dropped |
| • Invalid Dropped | Display invalid dropped |

Buttons

: Click to clear the statistics.

: Click to refresh the statistics.

4.9.7.6 Database Agent

Overview of the DHCP Snooping Database Agent

When DHCP snooping is enabled, the switch uses the DHCP snooping binding database to store information about untrusted interfaces. The database can have up to 8192 bindings.

Each database entry (*binding*) has an IP address, an associated MAC address, the lease time (in hexadecimal format), the interface to which the binding applies, and the VLAN to which the interface belongs. A *checksum* value, the end of each entry, is the number of bytes from the start of the file to end of the entry. Each entry is 72 bytes, followed by a space and then the checksum value.

To keep the bindings when the switch reloads, you must use the DHCP snooping database agent. If the agent is disabled, dynamic ARP or IP source guard is enabled, and the DHCP snooping binding database has dynamic bindings, the switch loses its connectivity. If the agent is disabled and only DHCP snooping is enabled, the switch does not lose its connectivity, but DHCP snooping might not prevent DHCP spoofing attacks.

The database agent stores the bindings in a file at a configured location. When reloading, the switch reads the binding file to build the DHCP snooping binding database. The switch keeps the file current by updating it when the database changes.

When a switch learns of new bindings or when it loses bindings, the switch immediately updates the entries in the database.

The switch also updates the entries in the binding file. The frequency at which the file is updated is based on a configurable delay, and the updates are batched. If the file is not updated in a specified time (set by the write-delay and abort-timeout values), the update stops.

The DHCP Snooping Database and Information screens in [Figure 4-9-40](#) & [Figure 4-9-41](#) appear.

DHCP Snooping Database

| | |
|----------------------|--|
| Database Type | <input type="text" value="None"/> |
| FileName | <input type="text"/> |
| Remote Server | <input type="text"/> (X.X.X.X or Hostname) |
| Write Delay | <input type="text" value="300"/> (15 ~ 86400 Second) |
| Timeout | <input type="text" value="300"/> (0 ~ 86400 Second) |

Figure 4-9-40 DHCP Snooping Database Setting Page Screenshot

The page includes the following fields:

| Object | Description |
|------------------------|---|
| • Database Type | Select database type |
| • File Name | The name of file image |
| • Remote Server | Fill in your remote server IP address |
| • Write Delay | Specify the duration for which the transfer should be delayed after the binding database changes. The range is from 15 to 86400 seconds. The default is 300 seconds (5 minutes). |
| • Timeout | Specify when to stop the database transfer process after the binding database changes. The range is from 0 to 86400. Use 0 for an infinite duration. The default is 300 seconds (5 minutes). |

Buttons

: Click to apply changes.

| DHCP Snooping Database Informations | |
|-------------------------------------|-------------------|
| Information Name | Information Value |
| Database Type | None |
| FileName | |
| Remote Server | |
| Write Delay | 300 |
| Timeout | 300 |

Figure 4-9-41 DHCP Snooping Database Information Page Screenshot

The page includes the following fields:

| Object | Description |
|-----------------|-----------------------------------|
| • Database Type | Display the current database type |
| • File Name | Display the current file name |
| • Remote Server | Display the current remote server |
| • Write Delay | Display the current write delay |
| • Timeout | Display the current timeout |

4.9.7.7 Rate Limit

After enabling DHCP snooping, the switch will monitor all the DHCP messages and implement software transmission. The DHCP Rate Limit Setting and Config screens in [Figure 4-9-42](#) & [Figure 4-9-43](#) appear.

| DHCP Rate Limit Setting | | |
|-------------------------|--|--|
| Port | State | Rate Limit (pps) |
| Select Ports | <input checked="" type="radio"/> Default <input type="radio"/> User-Define | <input type="text" value="Unlimited"/> (1~300 pps) |

Apply

Figure 4-9-42 DHCP Rate Limit Setting Page Screenshot

The page includes the following fields:

| Object | Description |
|--------------------|--|
| • Port | Select port from this drop-down list |
| • State | Set default or user-define |
| • Rate Limit (pps) | Configure the rate limit for the port policer. The default value is "unlimited". Valid values are in the range 1 to 300. |

Buttons

: Click to apply changes

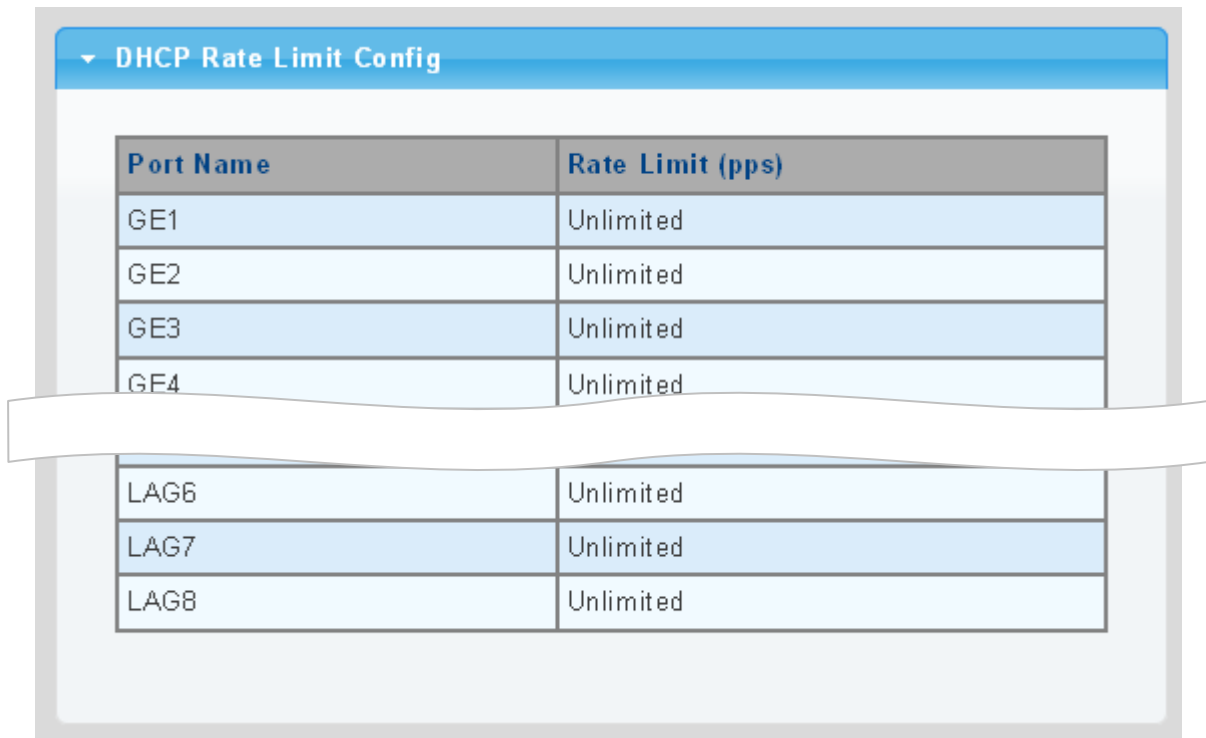

Figure 4-9-43 DHCP Rate Limit Setting Page Screenshot

The page includes the following fields:

| Object | Description |
|--------------------|--|
| • Port | The switch port number of the logical port |
| • Rate Limit (pps) | Display the current rate limit |

4.9.7.8 Option 82 Global Setting

DHCP provides a relay mechanism for sending information about the switch and its DHCP clients to DHCP servers. Known as **DHCP Option 82**, it allows compatible DHCP servers to use the information when assigning IP addresses, or to set other services or policies for clients. It is also an effective tool in preventing malicious network attacks from attached clients on DHCP services, such as IP Spoofing, Client Identifier Spoofing, MAC Address Spoofing, and Address Exhaustion.

The **DHCP option 82** enables a DHCP relay agent to insert specific information into a DHCP request packets when forwarding client DHCP packets to a DHCP server and remove the specific information from a DHCP reply packets when forwarding server DHCP packets to a DHCP client. The DHCP server can use this information to implement IP address or other assignment policies. Specifically the option works by setting two sub-options:

- Circuit ID (option 1)
- Remote ID (option 2)

The Circuit ID sub-option is supposed to include information specific to which circuit the request came in on.

The Remote ID sub-option was designed to carry information relating to the remote host end of the circuit.

The definition of Circuit ID in the switch is 4 bytes in length and the format is "vlan_id" "module_id" "port_no". The parameter of "vlan_id" is the first two bytes represent the VLAN ID. The parameter of "module_id" is the third byte for the module ID (in standalone switch it always equal 0, in switch it means switch ID). The parameter of "port_no" is the fourth byte and it means the port number.

After enabling DHCP snooping, the switch will monitor all the DHCP messages and implement software transmission. The DHCP Rate Limit Setting and Config screens in [Figure 4-9-44](#) & [Figure 4-9-45](#) appear.

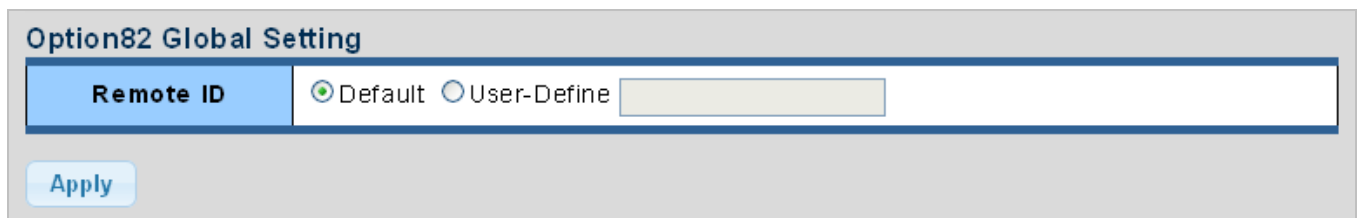



Figure 4-9-44 Option 82 Global Setting Page Screenshot

The page includes the following fields:

| Object | Description |
|--|--|
| <ul style="list-style-type: none"> • State | <p>Set the option 2 (remote ID option) content of option 82 added by DHCP request packets.</p> <ul style="list-style-type: none"> ■ Default means the default VLAN MAC format. ■ User-Define means the remote-id content of option 82 specified by users |

Buttons

: Click to apply changes.

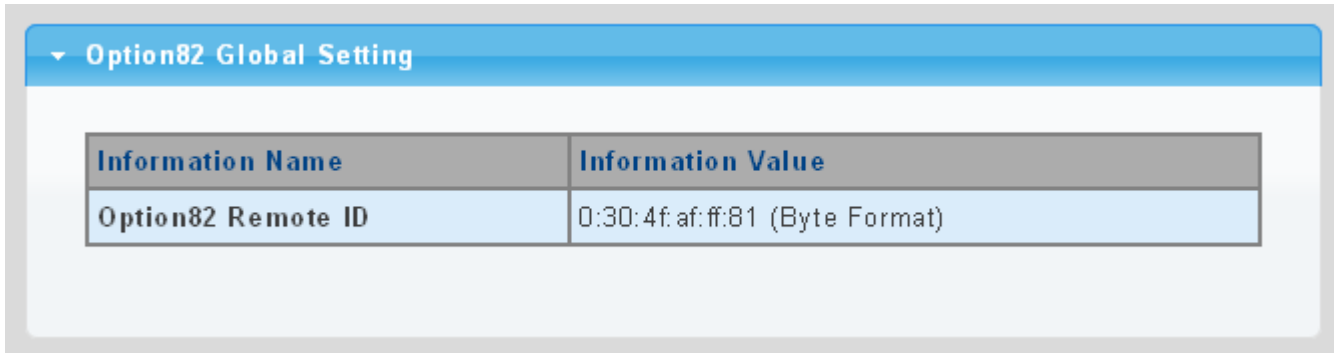

Figure 4-9-45 Option 82 Global Setting Page Screenshot

The page includes the following fields:

| Object | Description |
|-----------------------|---|
| • Option 82 Remote ID | Display the current option 82 remote ID |

4.9.7.9 Option 82 Port Setting

This function is used to set the retransmitting policy of the system for the received DHCP request message which contains option 82. The **drop** mode means that if the message has option 82, then the system will drop it without processing; **keep** mode means that the system will keep the original option 82 segment in the message, and forward it to the server to process; **replace** mode means that the system will replace the option 82 segment in the existing message with its own option 82, and forward the message to the server to process. Option 82 Port Setting screens in [Figure 4-9-46](#) & [Figure 4-9-47](#) appear.

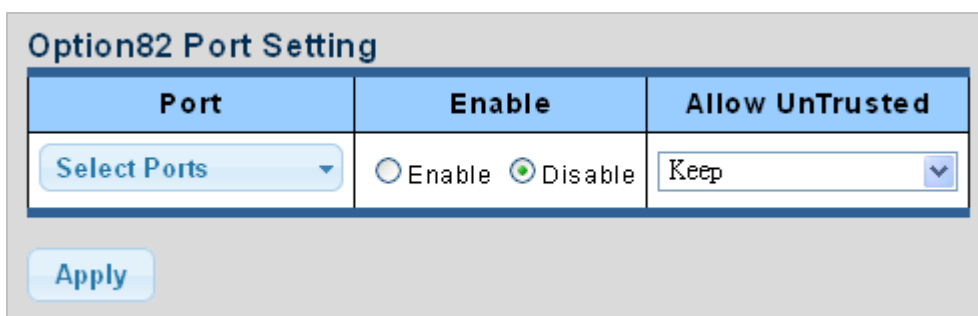



Figure 4-9-46 Option 82 Global Setting Page Screenshot

The page includes the following fields:

| Object | Description |
|-------------------|---|
| • Port | Select port from this drop-down list |
| • Enable | Enable or disable option 82 function on port |
| • Allow Untrusted | Select modes from this drop-down list. The following modes are available: <ul style="list-style-type: none"> ■ Drop ■ Keep ■ Replace |

Buttons

: Click to apply changes.

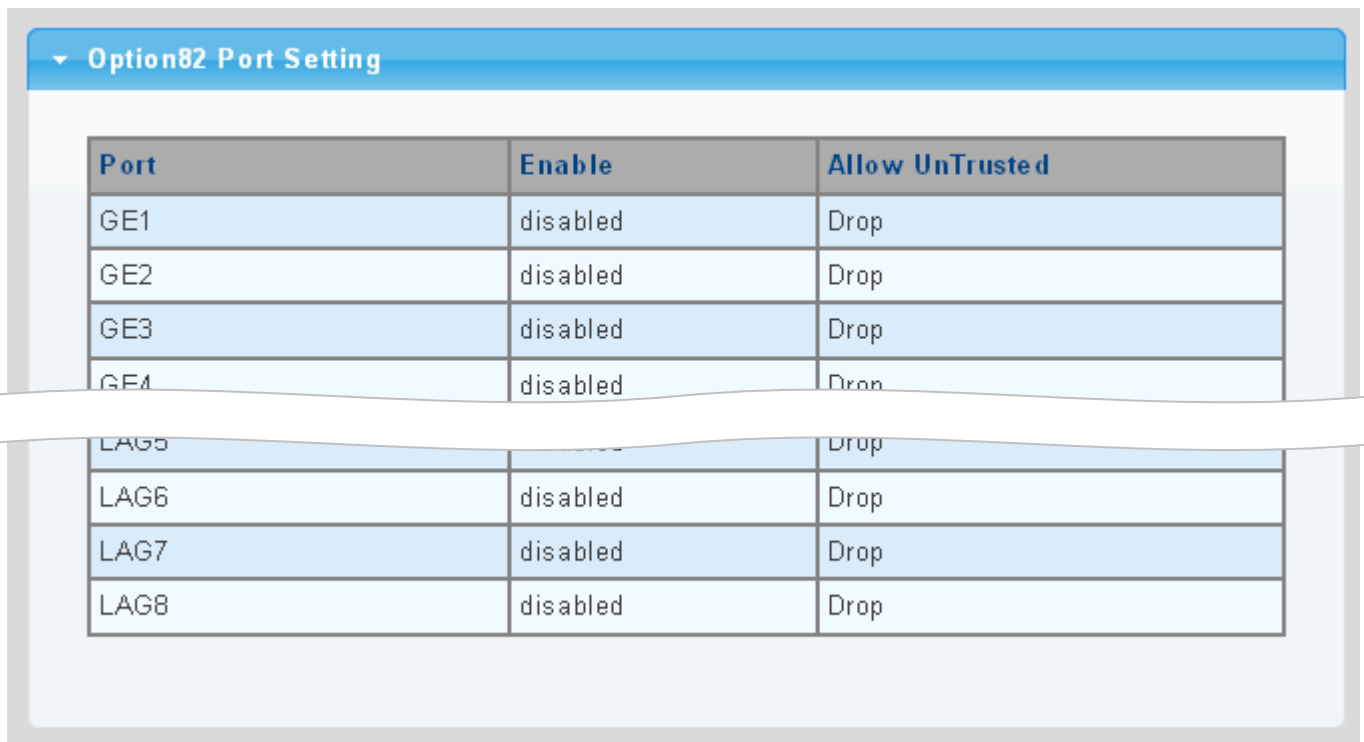

Figure 4-9-47 Option 82 Global Setting Page Screenshot

The page includes the following fields:

| Object | Description |
|-------------------|--|
| • Port | The switch port number of the logical port |
| • Enable | Display the current status |
| • Allow Untrusted | Display the current untrusted mode |

4.9.7.10 Option 82 Circuit-ID Setting

Set creation method for option 82, users can define the parameters of circuit-id suboption by themselves. Option 82 Circuit-ID Setting screens in [Figure 4-9-48](#) & [Figure 4-9-49](#) appear.

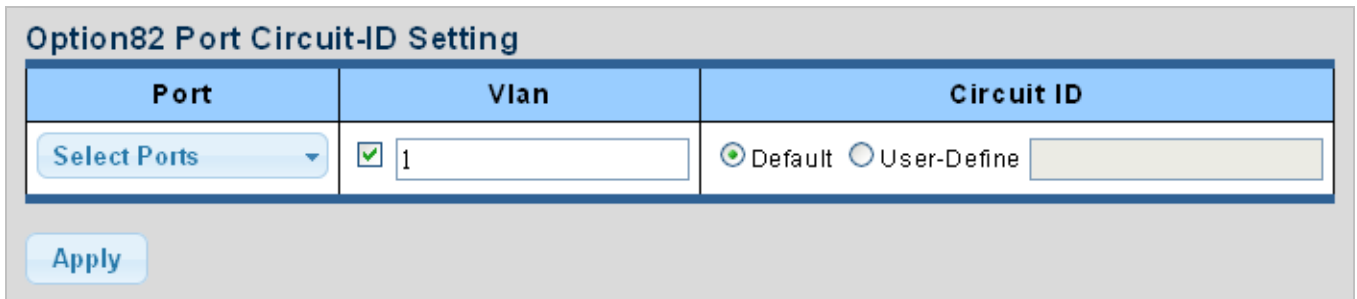



Figure 4-9-48 Option 82 Port Circuit-ID Setting Page Screenshot

The page includes the following fields:

| Object | Description |
|--------------|---|
| • Port | Select port for this drop down list |
| • VLAN | Indicates the ID of this particular VLAN |
| • Circuit ID | Set the option1 (Circuit ID) content of option 82 added by DHCP request packets |

Buttons

: Click to apply changes.

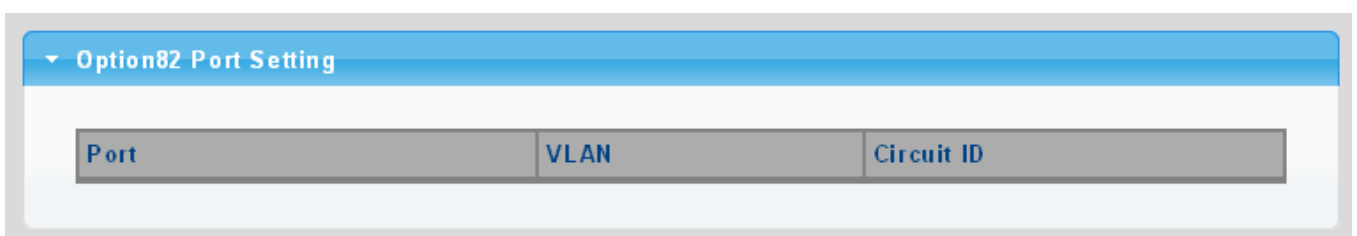

Figure 4-9-49 Option 82 Port Circuit-ID Setting Page Screenshot

The page includes the following fields:

| Object | Description |
|--------------|--------------------------------|
| • Port | Display the current port |
| • VLAN | Display the current VLAN |
| • Circuit ID | Display the current circuit ID |

4.9.8 Dynamic ARP Inspection

Dynamic ARP Inspection (DAI) is a secure feature. Several types of attacks can be launched against a host or devices connected to Layer 2 networks by "poisoning" the ARP caches. This feature is used to block such attacks. Only valid ARP requests and responses can go through DUT. This page provides ARP Inspection related configuration.



A Dynamic ARP prevents the untrusted ARP packets based on the DHCP Snooping Database.

4.9.8.1 Global Setting

DAI Setting and Information screens in [Figure 4-9-50](#) & [Figure 4-9-51](#) appear.



Figure 4-9-50 DAI Setting Page Screenshot

The page includes the following fields:

| Object | Description |
|--------|---|
| • DAI | Enable the Global Dynamic ARP Inspection or disable the Global ARP Inspection |

Buttons

: Click to apply changes.

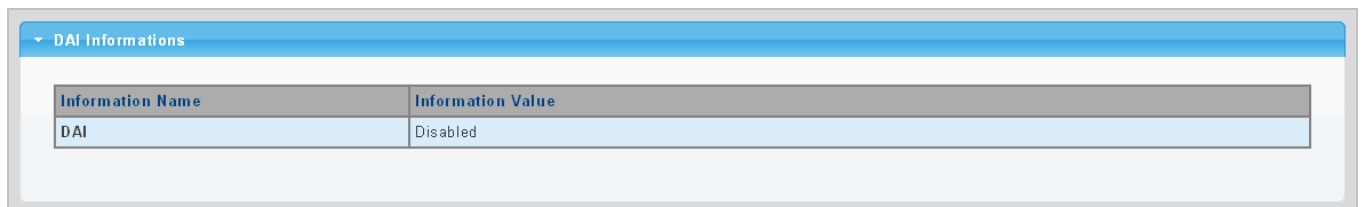

Figure 4-9-51 DAI Information Page Screenshot

The page includes the following fields:

| Object | Description |
|--------|--------------------------------|
| • DAI | Display the current DAI status |

4.9.8.2 VLAN Setting

DAI VLAN Setting screens in [Figure 4-9-52](#) & [Figure 4-9-53](#) appear.

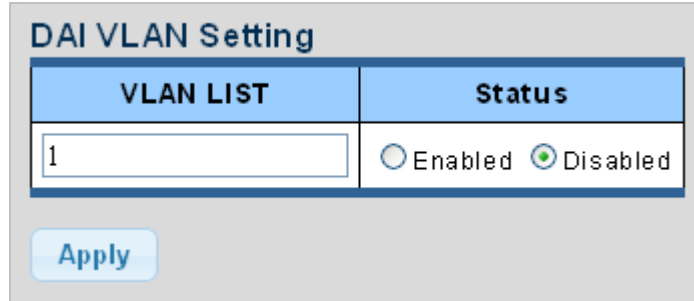

Figure 4-9-52 DAI VLAN Setting Page Screenshot

The page includes the following fields:

| Object | Description |
|---|--|
| <ul style="list-style-type: none"> VLAN ID | Indicates the ID of this particular VLAN |
| Status | Enables Dynamic ARP Inspection on the specified VLAN Options: <ul style="list-style-type: none"> ■ Enable ■ Disable |

Buttons

: Click to apply changes.

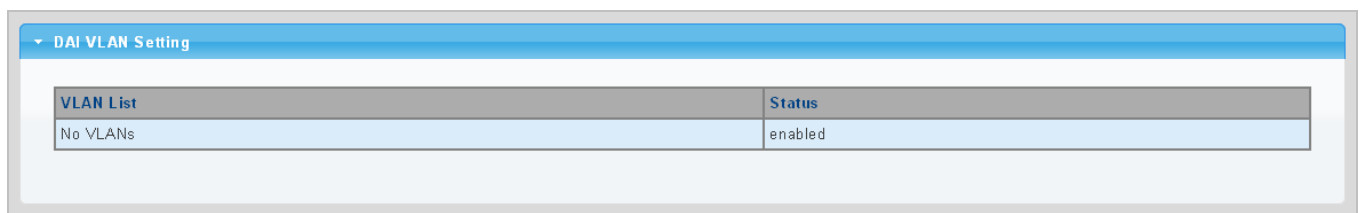

Figure 4-9-53 DAI VLAN Setting Page Screenshot

The page includes the following fields:

| Object | Description |
|---|-------------------------------|
| <ul style="list-style-type: none"> VLAN List | Display the current VLAN list |
| <ul style="list-style-type: none"> Status | Display the current status |

4.9.8.3 Port Setting

Configures switch ports as DAI trusted or untrusted and check mode. DAI Port Setting screens in [Figure 4-9-54](#) & [Figure 4-9-55](#) appear.

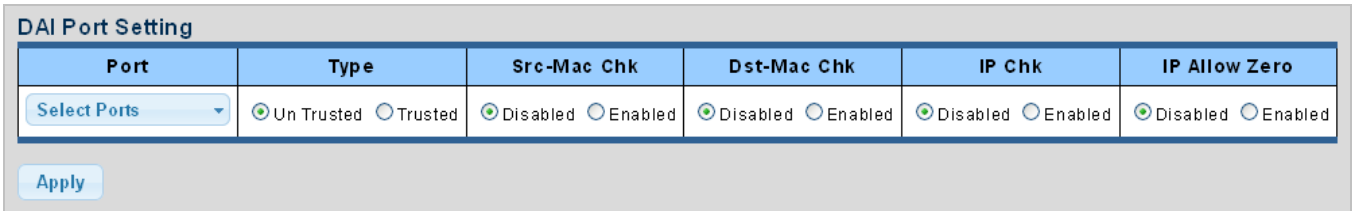

| Port | Type | Src-Mac Chk | Dst-Mac Chk | IP Chk | IP Allow Zero |
|--------------|---|---|---|---|---|
| Select Ports | <input checked="" type="radio"/> Un Trusted <input type="radio"/> Trusted | <input checked="" type="radio"/> Disabled <input type="radio"/> Enabled | <input checked="" type="radio"/> Disabled <input type="radio"/> Enabled | <input checked="" type="radio"/> Disabled <input type="radio"/> Enabled | <input checked="" type="radio"/> Disabled <input type="radio"/> Enabled |

Apply

Figure 4-9-54 DAI Port Setting Page Screenshot

The page includes the following fields:

| Object | Description |
|---|---|
| <ul style="list-style-type: none"> • Port | Select port from this drop-down list |
| <ul style="list-style-type: none"> • Type | Specify ARP Inspection is enabled on which ports. Only when both Global Mode and Port Mode on a given port are enabled, ARP Inspection is enabled on this given port. Default: All interfaces are untrusted. |
| <ul style="list-style-type: none"> • Src-Mac Chk | Enable or disable to checks the source MAC address in the Ethernet header against the sender MAC address in the ARP body. This check is performed on both ARP requests and responses. When enabled, packets with different MAC addresses are classified as invalid and are dropped. |
| <ul style="list-style-type: none"> • Dst-Mac Chk | Enable or disable to checks the destination MAC address in the Ethernet header against the target MAC address in ARP body. This check is performed for ARP responses. When enabled, packets with different MAC addresses are classified as invalid and are dropped. |
| <ul style="list-style-type: none"> • IP Chk | Enable or disable to checks the source and destination IP addresses of ARP packets. The all-zero, all-one or multicast IP addresses are considered invalid and the corresponding packets are discarded. |
| <ul style="list-style-type: none"> • IP Allow Zero | Enable or disable to check all-zero IP addresses. |

Buttons

: Click to apply changes.

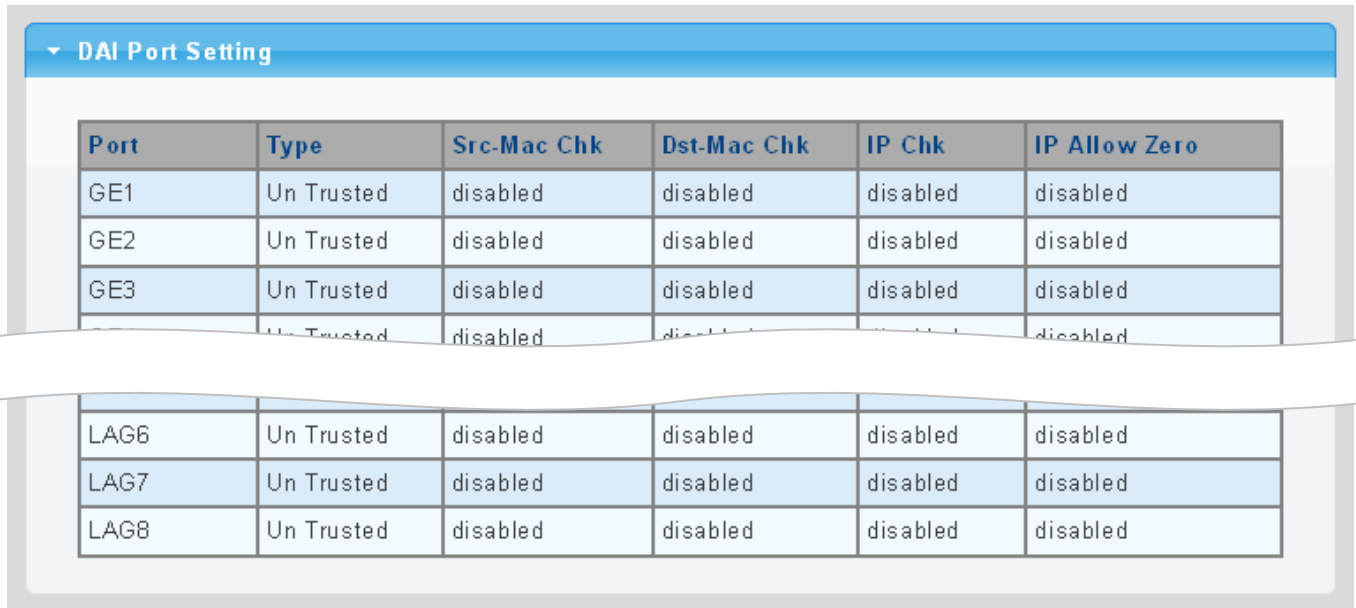

| DAI Port Setting | | | | | |
|------------------|------------|-------------|-------------|----------|---------------|
| Port | Type | Src-Mac Chk | Dst-Mac Chk | IP Chk | IP Allow Zero |
| GE1 | Un Trusted | disabled | disabled | disabled | disabled |
| GE2 | Un Trusted | disabled | disabled | disabled | disabled |
| GE3 | Un Trusted | disabled | disabled | disabled | disabled |
| GE4 | Un Trusted | disabled | disabled | disabled | disabled |
| LAG6 | Un Trusted | disabled | disabled | disabled | disabled |
| LAG7 | Un Trusted | disabled | disabled | disabled | disabled |
| LAG8 | Un Trusted | disabled | disabled | disabled | disabled |

Figure 4-9-55 DAI Port Setting Page Screenshot

The page includes the following fields:

| Object | Description |
|-----------------|--|
| • Port | The switch port number of the logical port |
| • Type | Display the current port type |
| • Src-Mac Chk | Display the current Src-Mac Chk status |
| • Dst-Mac Chk | Display the current Dst-Mac Chk status |
| • IP Chk | Display the current IP Chk status |
| • IP Allow Zero | Display the current IP allow zero status |

4.9.8.4 Statistics

Configures switch ports as DAI trusted or untrusted and check mode. DAI Port Setting screen in [Figure 4-9-56](#) appears.

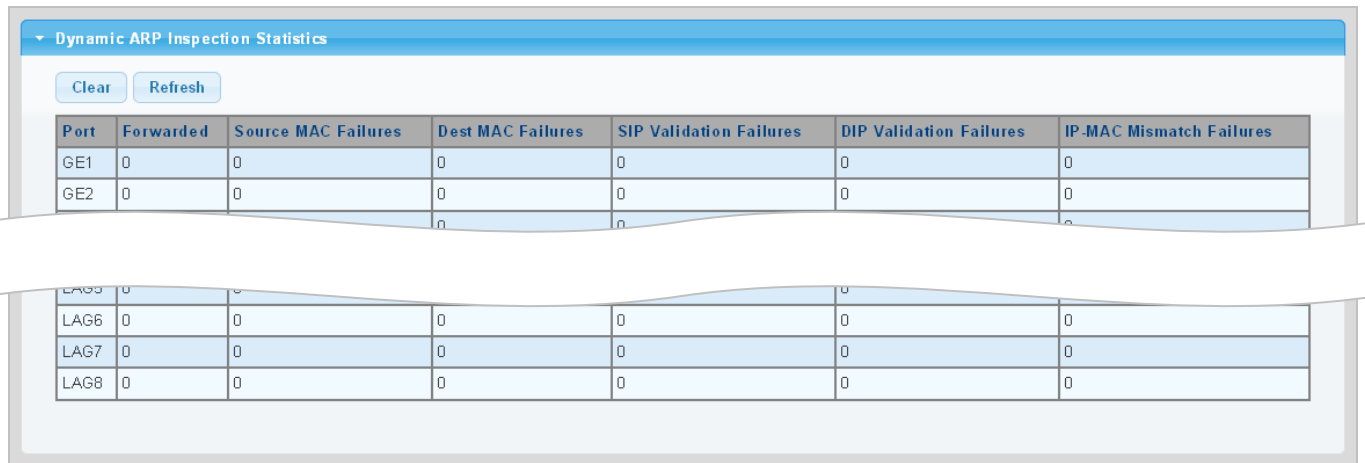

Figure 4-9-56 DAI Port Setting Page Screenshot

The page includes the following fields:

| Object | Description |
|----------------------------|--|
| • Port | The switch port number of the logical port |
| • Forwarded | Display the current forwarded |
| • Source MAC Failures | Display the current source MAC failures |
| • Dest MAC Failures | Display the current source MAC failures |
| • SIP Validation Failures | Display the current SIP Validation failures |
| • DIP Validation Failures | Display the current DIP Validation failures |
| • IP-MAC Mismatch Failures | Display the current IP-MAC mismatch failures |

Buttons

Clear: Click to clear the statistics.

Refresh: Click to refresh the statistics.

4.9.8.5 Rate Limit

The ARP Rate Limit Setting and Config screens in [Figure 4-9-57](#) & [Figure 4-9-58](#) appear.

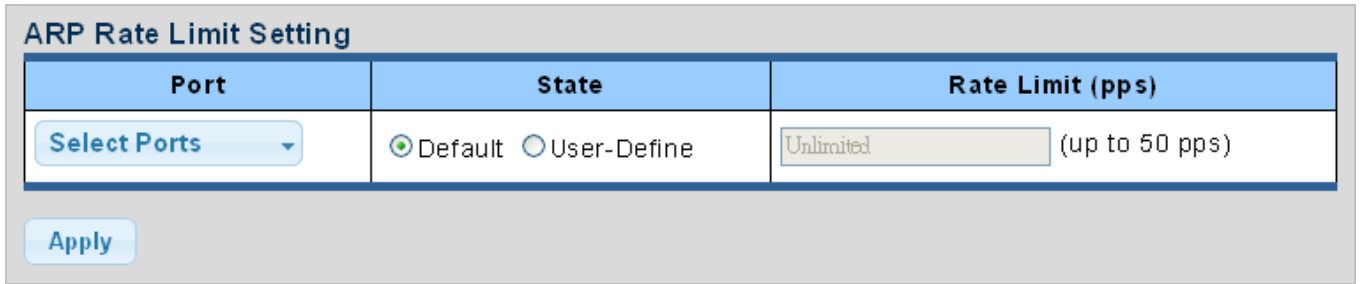



Figure 4-9-57 ARP Rate Limit Setting Page Screenshot

The page includes the following fields:

| Object | Description |
|--------------------|--|
| • Port | Select port from this drop-down list |
| • State | Set default or user-define |
| • Rate Limit (pps) | Configure the rate limit for the port policer. The default value is "unlimited". |

Buttons

: Click to apply changes.

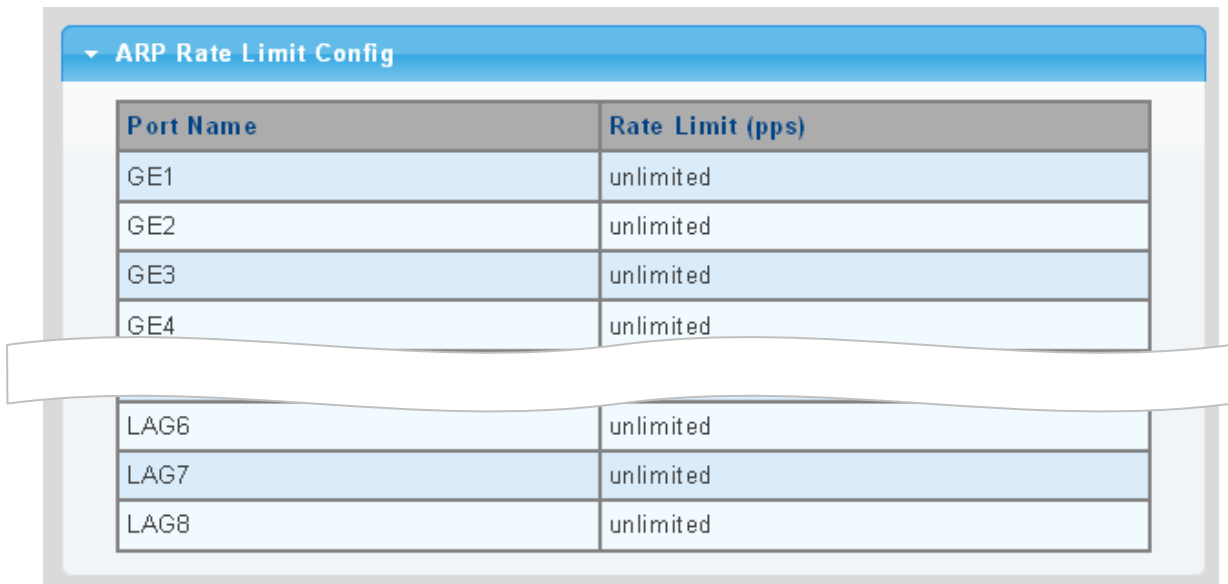

Figure 4-9-58 ARP Rate Limit Setting Page Screenshot

The page includes the following fields:

| Object | Description |
|--------------------|--|
| • Port | The switch port number of the logical port |
| • Rate Limit (pps) | Display the current rate limit |

4.9.9 IP Source Guard

IP Source Guard is a secure feature used to restrict IP traffic on DHCP snooping untrusted ports by filtering traffic based on the DHCP Snooping Table or manually configured IP Source Bindings. It helps prevent IP spoofing attacks when a host tries to spoof and use the IP address of another host.

After receiving a packet, the port looks up the key attributes (including IP address, MAC address and VLAN tag) of the packet in the binding entries of the IP source guard. If there is a matching entry, the port will forward the packet. Otherwise, the port will abandon the packet.

IP source guard filters packets based on the following types of binding entries:

- IP-port binding entry
- MAC-port binding entry
- IP-MAC-port binding entry

IP Source Guard Overview

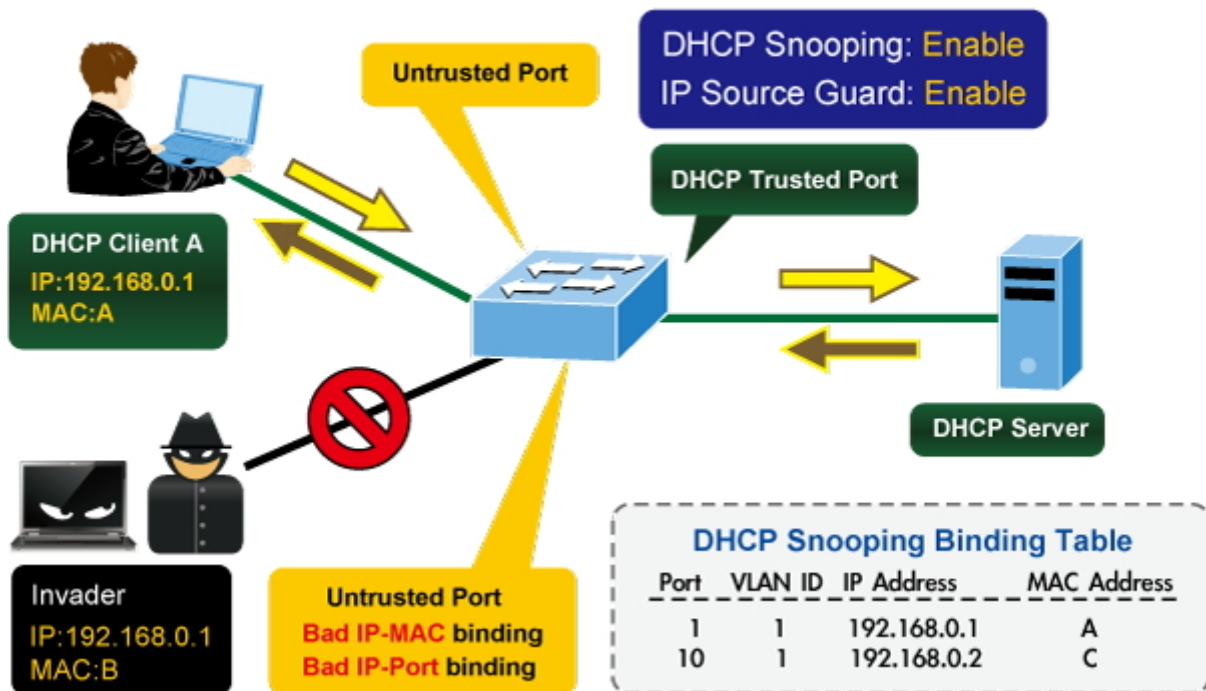

4.9.9.1 Port Settings

IP Source Guard is a secure feature used to restrict IP traffic on **DHCP snooping untrusted ports** by filtering traffic based on the DHCP Snooping Table or manually configured IP Source Bindings. It helps prevent IP spoofing attacks when a host tries to spoof and use the IP address of another host.

The IP Source Guard Port Setting and Information screens in [Figure 4-9-60](#) & [Figure 4-9-61](#) appear.

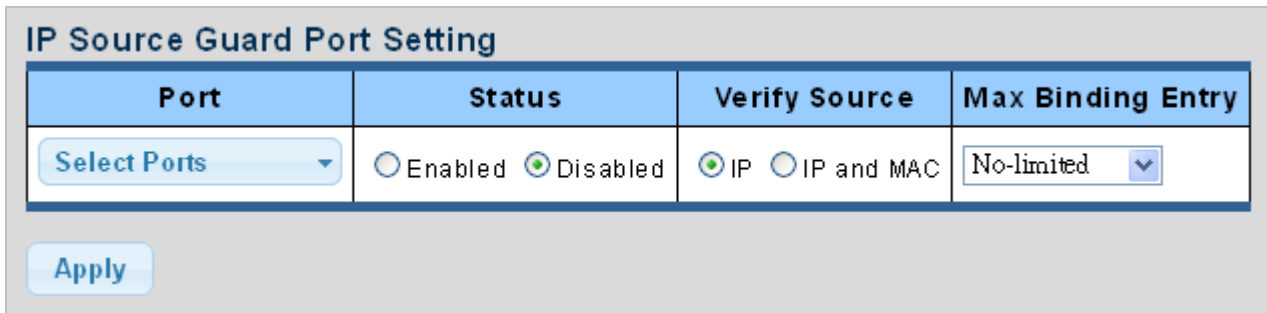

| Port | Status | Verify Source | Max Binding Entry |
|--------------|---|--|-------------------|
| Select Ports | <input type="radio"/> Enabled <input checked="" type="radio"/> Disabled | <input checked="" type="radio"/> IP <input type="radio"/> IP and MAC | No-limited |

Apply

Figure 4-9-60 IP Source Guard Port Setting Page Screenshot

The page includes the following fields:

| Object | Description |
|--|--|
| <ul style="list-style-type: none"> • Port | Select port from this drop-down list |
| <ul style="list-style-type: none"> • Status | Enable or disable the IP source guard |
| <ul style="list-style-type: none"> • Verify Source | Configures the switch to filter inbound traffic based IP address, or IP address and MAC address. <ul style="list-style-type: none"> ■ None Disables IP source guard filtering on the LRP Managed Switch. ■ IP Enables traffic filtering based on IP addresses stored in the binding table. ■ IP and MAC Enables traffic filtering based on IP addresses and corresponding MAC addresses stored in the binding table. |
| <ul style="list-style-type: none"> • Max Binding Entry | The maximum number of IP source guard that can be secured on this port |

Buttons

: Click to apply changes.

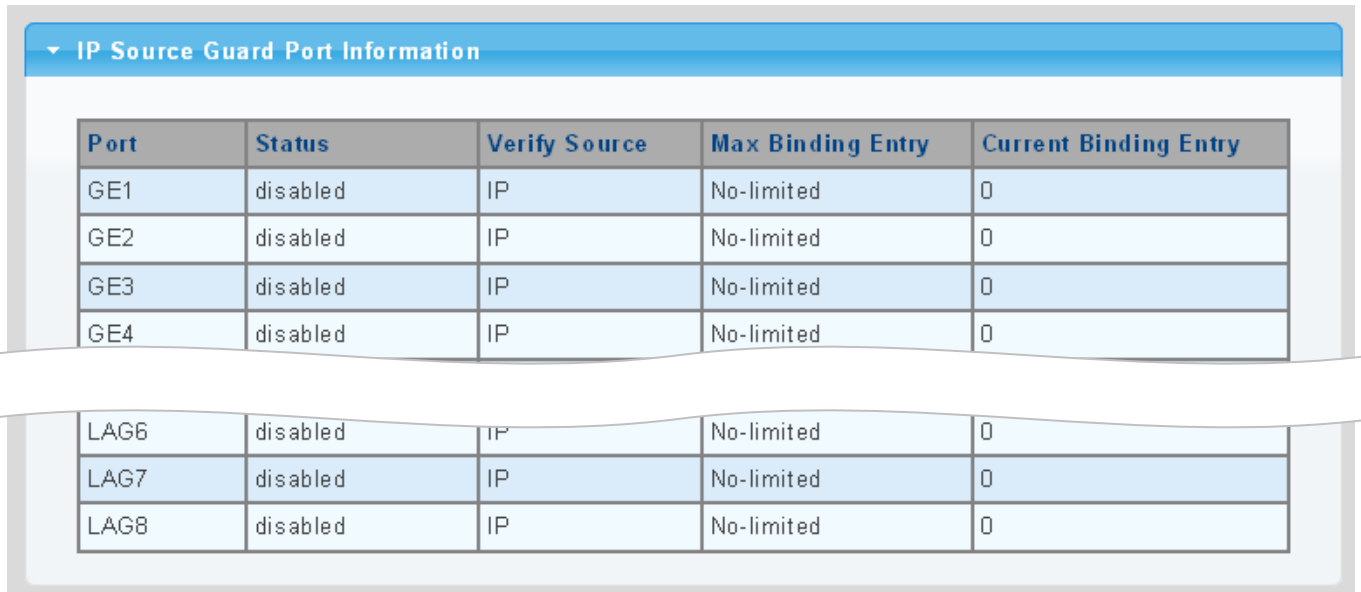

| IP Source Guard Port Information | | | | |
|----------------------------------|----------|---------------|-------------------|-----------------------|
| Port | Status | Verify Source | Max Binding Entry | Current Binding Entry |
| GE1 | disabled | IP | No-limited | 0 |
| GE2 | disabled | IP | No-limited | 0 |
| GE3 | disabled | IP | No-limited | 0 |
| GE4 | disabled | IP | No-limited | 0 |
| LAG6 | disabled | IP | No-limited | 0 |
| LAG7 | disabled | IP | No-limited | 0 |
| LAG8 | disabled | IP | No-limited | 0 |

Figure 4-9-61 IP Source Guard Port Setting Page Screenshot

The page includes the following fields:

| Object | Description |
|-------------------------|--|
| • Port | The switch port number of the logical port |
| • Status | Display the current status |
| • Verify Source | Display the current verify source |
| • Max Binding Entry | Display the current max binding entry |
| • Current Binding Entry | Display the current binding entry |

4.9.9.2 Binding Table

The IP Source Guard Static Binding Entry and Table Status screens in [Figure 4-9-62](#) & [Figure 4-9-63](#) appear.

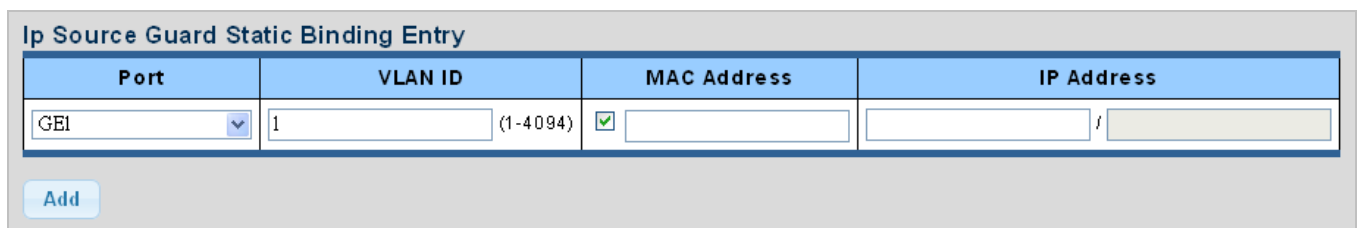

| Ip Source Guard Static Binding Entry | | | |
|--------------------------------------|------------|-------------------------------------|------------|
| Port | VLAN ID | MAC Address | IP Address |
| GE1 | 1 (1-4094) | <input checked="" type="checkbox"/> | / |

Figure 4-9-62 IP Source Guard Static Binding Entry Page Screenshot

The page includes the following fields:

| Object | Description |
|---------------|--|
| • Port | Select port from this drop-down list |
| • VLAN ID | Indicates the ID of this particular VLAN |
| • MAC Address | Sourcing MAC address is allowed |
| • IP Address | Sourcing IP address is allowed |

Buttons

 : Click to add authentication list

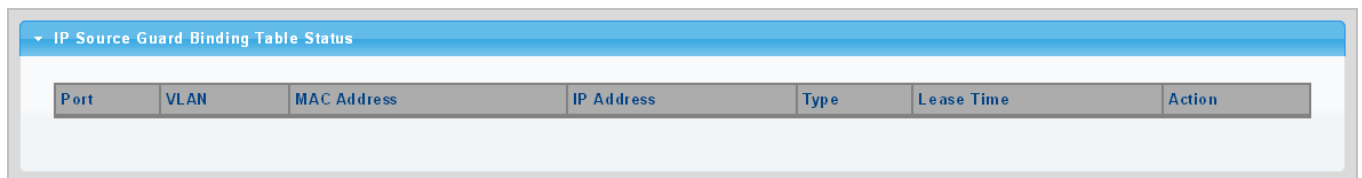



Figure 4-9-63 IP Source Guard Binding Table Status Page Screenshot

The page includes the following fields:

| Object | Description |
|---------------|--|
| • Port | Display the current port |
| • VLAN ID | Display the current VLAN |
| • MAC Address | Display the current MAC address |
| • IP Address | Display the current IP Address |
| • Type | Display the current entry type |
| • Lease Time | Display the current lease time |
| • Action | Click  to delete IP source guard binding table status entry |

4.9.10 Port Security

This page allows you to configure the Port Security Limit Control system and port settings. Limit Control allows for limiting the number of users on a given port. A user is identified by a MAC address and VLAN ID. If Limit Control is enabled on a port, the limit specifies the maximum number of users on the port. If this number is exceeded, an action is taken. The action can be one of the four as described below.

The Limit Control module is one of a range of modules that utilizes a lower-layer module, the Port Security module, which manages MAC addresses learned on the port.

The Limit Control configuration consists of two sections, a system- and a port-wide. The IP Source Guard Static Binding Entry and Table Status screens in [Figure 4-9-64](#) & [Figure 4-9-65](#) appear.

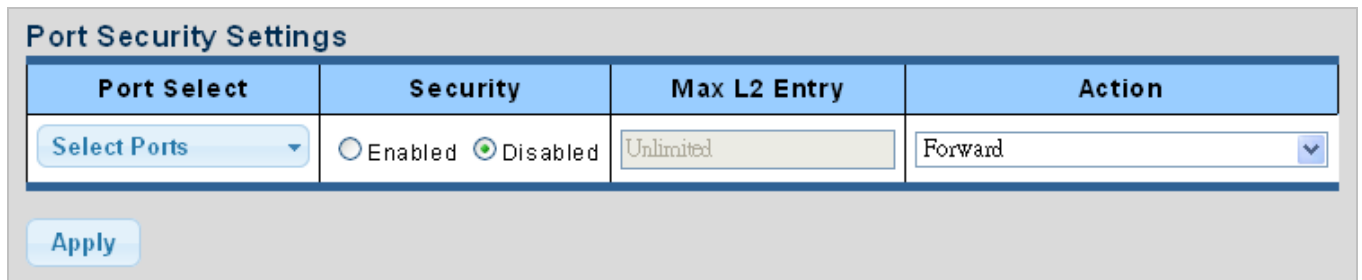



Figure 4-9-64 Port Security Setting Page Screenshot

The page includes the following fields:

| Object | Description |
|---|--|
| <ul style="list-style-type: none"> • Port | Select port from this drop-down list |
| <ul style="list-style-type: none"> • Security | Enable or disable the port security |
| <ul style="list-style-type: none"> • Mac L2 Entry | <p>The maximum number of MAC addresses that can be secured on this port. If the limit is exceeded, the corresponding action is taken.</p> <p>The switch is "born" with a total number of MAC addresses from which all ports draw whenever a new MAC address is seen on a Port Security-enabled port. Since all ports draw from the same pool, it may happen that a configured maximum cannot be granted, if the remaining ports have already used all available MAC addresses.</p> |
| <ul style="list-style-type: none"> • Action | <p>If Limit is reached, the switch can take one of the following actions:</p> <ul style="list-style-type: none"> ■ Forward: Do not allow more than Limit MAC addresses on the port, but take no further action. ■ Shutdown: If Limit + 1 MAC addresses is seen on the port, shut down the port. This implies that all secured MAC addresses will be removed from the port, and no new will be learned. Even if the link is physically disconnected |

| | |
|--|--|
| | <p>and reconnected on the port (by disconnecting the cable), the port will remain shut down. There are three ways to re-open the port:</p> <ol style="list-style-type: none"> 1) Disable and re-enable Limit Control on the port or the switch, 2) Click the Reopen button. <ul style="list-style-type: none"> ■ Discard: If Limit + 1 MAC addresses is seen on the port, it will trigger the action that do not learn the new MAC and drop the package. |
|--|--|

Buttons

: Click to apply changes.

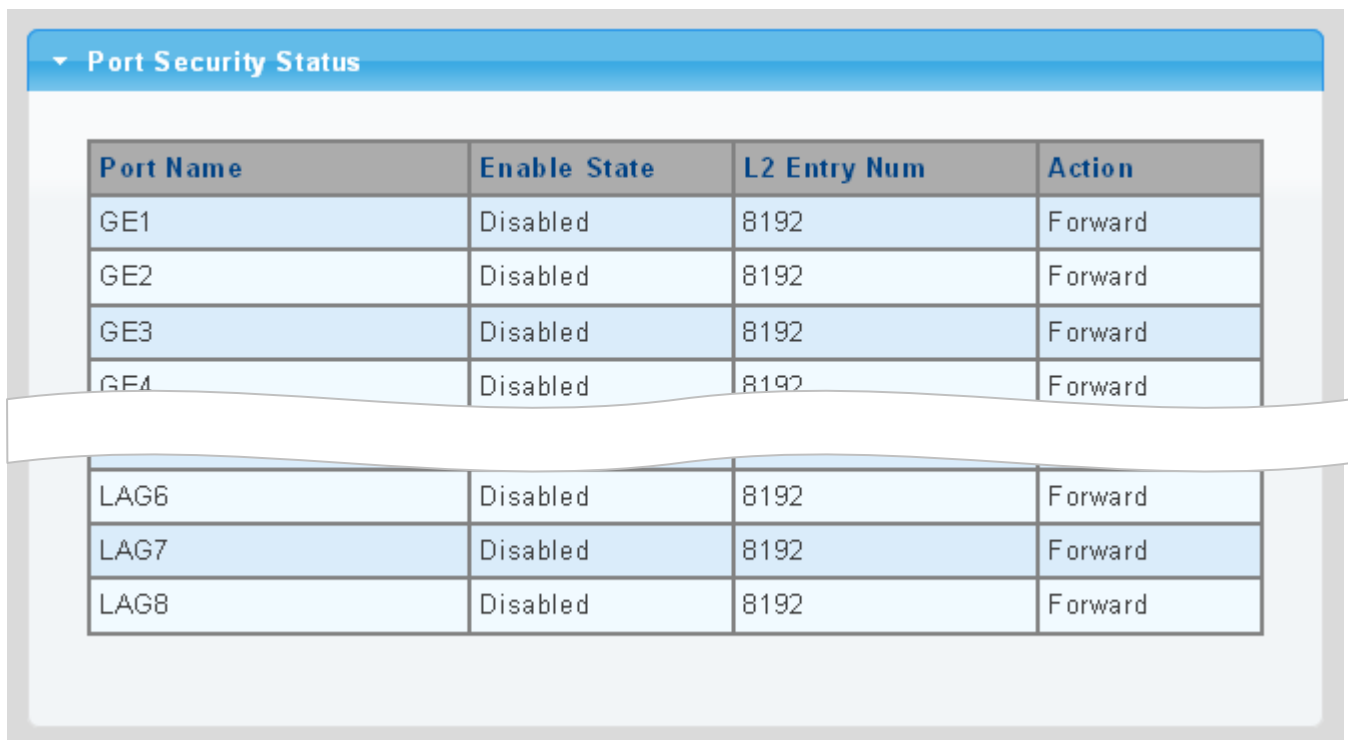

Figure 4-9-65 Port Security Status Page Screenshot

The page includes the following fields:

| Object | Description |
|-----------------------|--|
| • Port Name | The switch port number of the logical port |
| • Enable State | Display the current per port security status |
| • L2 Entry Num | Display the current L2 entry number |
| • Action | Display the current action |

4.9.11 DoS

The DoS is short for Denial of Service, which is a simple but effective destructive attack on the internet. The server under DoS attack will drop normal user data packet due to non-stop processing the attacker's data packet, leading to the denial of the service and worse can lead to leak of sensitive data of the server.

Security feature refers to applications such as protocol check which is for protecting the server from attacks such as DoS. The protocol check allows the user to drop matched packets based on specified conditions. The security features provide several simple and effective protections against Dos attacks while acting no influence on the linear forwarding performance of the switch.

4.9.11.1 Global DoS Setting

The Global DoS Setting and Information screens in [Figure 4-9-66](#) & [Figure 4-9-67](#) appear.

Global DoS Setting

| | |
|----------------------------------|--|
| DMAC = SMAC | <input checked="" type="radio"/> Enabled <input type="radio"/> Disabled |
| Land | <input checked="" type="radio"/> Enabled <input type="radio"/> Disabled |
| UDP Blat | <input checked="" type="radio"/> Enabled <input type="radio"/> Disabled |
| TCP Blat | <input checked="" type="radio"/> Enabled <input type="radio"/> Disabled |
| POD | <input checked="" type="radio"/> Enabled <input type="radio"/> Disabled |
| IPv6 Min Fragment | <input checked="" type="radio"/> Enabled <input type="radio"/> Disabled Byte: <input type="text" value="1240"/> (0-65535) |
| ICMP Fragments | <input checked="" type="radio"/> Enabled <input type="radio"/> Disabled |
| IPv4 Ping Max Size | <input checked="" type="radio"/> Enabled <input type="radio"/> Disabled |
| IPv6 Ping Max Size | <input checked="" type="radio"/> Enabled <input type="radio"/> Disabled |
| Ping Max Size Setting | Byte: <input type="text" value="512"/> (0-65535) |
| Smurf Attack | <input checked="" type="radio"/> Enabled <input type="radio"/> Disabled Netmask Length: <input type="text" value="0"/> (0-32) |
| TCP Min Hdr Size | <input checked="" type="radio"/> Enabled <input type="radio"/> Disabled Bytes: <input type="text" value="20"/> (0-31) |
| TCP-SYN(SPORT<1024) | <input checked="" type="radio"/> Enabled <input type="radio"/> Disabled |
| Null Scan Attack | <input checked="" type="radio"/> Enabled <input type="radio"/> Disabled |
| X-Mas Scan Attack | <input checked="" type="radio"/> Enabled <input type="radio"/> Disabled |
| TCP SYN-FIN Attack | <input checked="" type="radio"/> Enabled <input type="radio"/> Disabled |
| TCP SYN-RST Attack | <input checked="" type="radio"/> Enabled <input type="radio"/> Disabled |
| TCP Fragment (Offset = 1) | <input checked="" type="radio"/> Enabled <input type="radio"/> Disabled |

Figure 4-9-66 Global DoS Setting Page Screenshot

The page includes the following fields:

| Object | Description |
|----------------------|---|
| • DMAC = SMAC | Enable or disable DoS check mode by DMAC = SMAC |
| • Land | Enable or disable DoS check mode by land |
| • UDP Blat | Enable or disable DoS check mode by UDP blat |
| • TCP Blat | Enable or disable DoS check mode by TCP blat |
| • POD | Enable or disable DoS check mode by POD |

| | |
|-----------------------------|---|
| • IPv6 Min Fragment | Enable or disable DoS check mode by IPv6 min fragment |
| • ICMP Fragments | Enable or disable DoS check mode by ICMP fragment |
| • IPv4 Ping Max Size | Enable or disable DoS check mode by IPv4 ping max size |
| • IPv6 Ping Max Size | Enable or disable DoS check mode by IPv6 ping max size |
| • Ping Max Size Setting | Set the max size for ping |
| • Smurf Attack | Enable or disable DoS check mode by smurf attack |
| • TCP Min Hdr Size | Enable or disable DoS check mode by TCP min hdr size |
| • TCP-SYN (SPORT < 1024) | Enable or disable DoS check mode by TCP-syn (sport < 1024) |
| • Null Scan Attack | Enable or disable DoS check mode by null scan attack |
| • X-mas Scan Attack | Enable or disable DoS check mode by X-mas scan attack |
| • TCP SYN-FIN Attack | Enable or disable DoS check mode by TCP syn-fin attack |
| • TCP SYN-RST Attack | Enable or disable DoS check mode by TCP syn-rst attack |
| • TCP Fragment (Offset = 1) | Enable or disable DoS check mode by TCP fragment (offset = 1) |

Buttons



: Click to apply changes.

| DoS Informations | |
|---------------------------|-----------------------------|
| Information Name | Information Value |
| DMAC = SMAC | Enabled |
| Land Attack | Enabled |
| UDP Blat | Enabled |
| TCP Blat | Enabled |
| POD (Ping of Death) | Enabled |
| IPv6 Min Fragment Size | Enabled (1240 Bytes) |
| ICMP Fragment Packets | Enabled |
| IPv4 Ping Max Packet Size | Enabled (512 Bytes) |
| IPv6 Ping Max Packet Size | Enabled (512 Bytes) |
| Smurf Attack | Enabled (Netmask Length: 0) |
| TCP Min Header Length | Enabled (20 Bytes) |
| TCP Syn (SPORT < 1024) | Enabled |
| Null Scan Attack | Enabled |
| X-Mas Scan Attack | Enabled |
| TCP SYN-FIN Attack | Enabled |
| TCP SYN-RST Attack | Enabled |
| TCP Fragment (Offset = 1) | Enabled |

Figure 4-9-67 DoS Information Page Screenshot

The page includes the following fields:

| Object | Description |
|------------------------------------|---|
| • DMAC = SMAC | Display the current DMAC = SMAC status |
| • Land Attach | Display the current land attach status |
| • UDP Blat | Display the current UDP blat status |
| • TCP Blat | Display the current TCP blat status |
| • POD | Display the current POD status |
| • IPv6 Min Fragment | Display the current IPv6 min fragment status |
| • ICMP Fragments | Display the current ICMP fragment status |
| • IPv4 Ping Max Size | Display the current IPv4 ping max size status |
| • IPv6 Ping Max Size | Display the current IPv6 ping max size status |
| • Smurf Attack | Display the current smurf attack status |
| • TCP Min Header Length | Display the current TCP min header length |
| • TCP-SYN (SPORT < 1024) | Display the current TCP syn status |
| • Null Scan Attack | Display the current null scan attack status |
| • X-mas Scan Attack | Display the current X-mas scan attack status |
| • TCP SYN-FIN Attack | Display the current TCP syn-fin attack status |
| • TCP SYN-RST Attack | Display the current TCP syn-rst attack status |
| • TCP Fragment (Offset = 1) | Display the TCP fragment (offset = 1) status |

4.9.11.2 DoS Port Setting

The DoS Port Setting and Status screens in [Figure 4-9-68](#) & [Figure 4-9-69](#) appear.

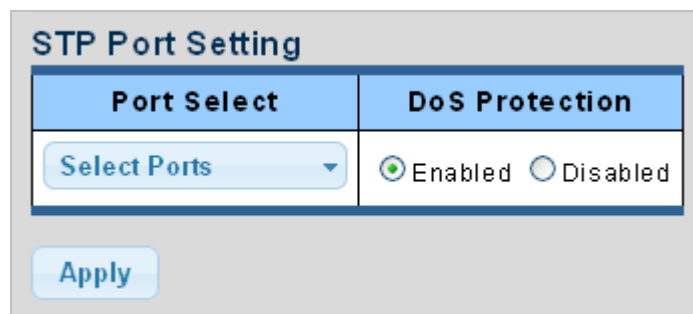



Figure 4-9-68 Port Security Setting Page Screenshot

The page includes the following fields:

| Object | Description |
|------------------|--|
| • Port Select | Select port from this drop-down list. |
| • DoS Protection | Enable or disable per port DoS protection. |

Buttons

: Click to apply changes.

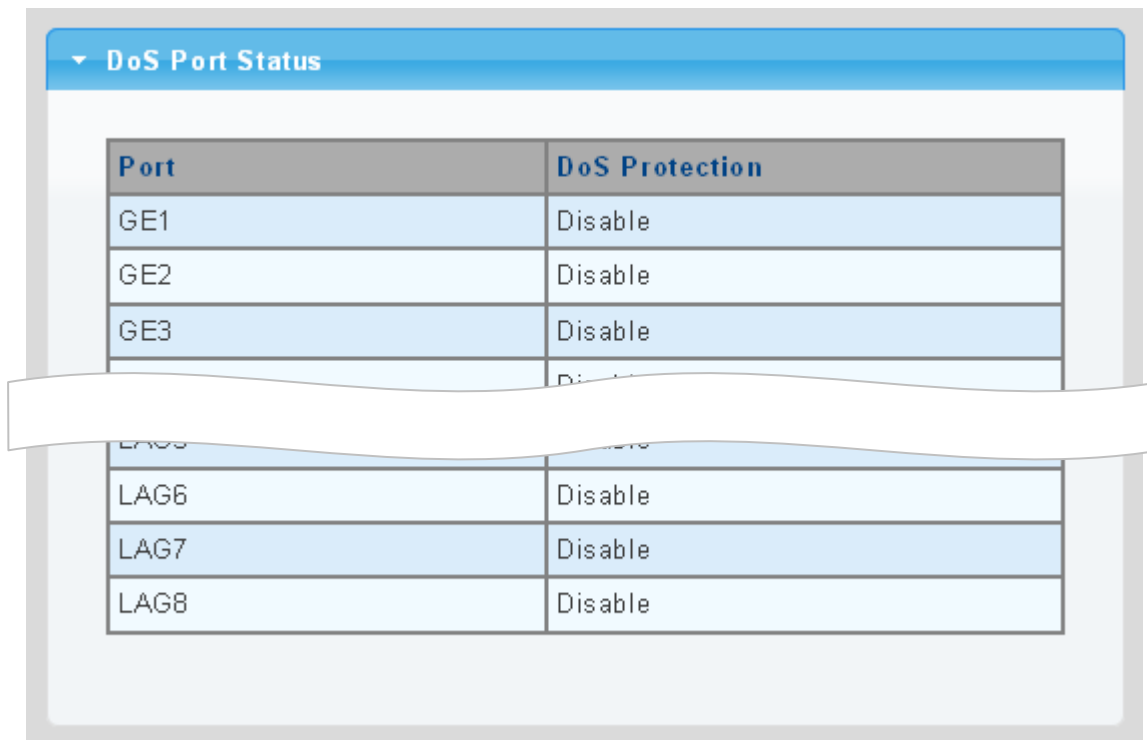

Figure 4-9-68 Port Security Setting Page Screenshot

The page includes the following fields:

| Object | Description |
|------------------|--|
| • Port | The switch port number of the logical port |
| • DoS Protection | Display the current DoS protection |

4.9.12 Storm Control

Storm control for the switch is configured on this page.

There is an unknown unicast storm rate control, unknown multicast storm rate control, and a broadcast storm rate control. These only affect flooded frames, i.e. frames with a (VLAN ID, DMAC) pair not present on the MAC Address table.

4.9.12.1 Global Setting

The Storm Control Global Setting and Information screens in [Figure 4-9-69](#) & [Figure 4-9-70](#) appear.

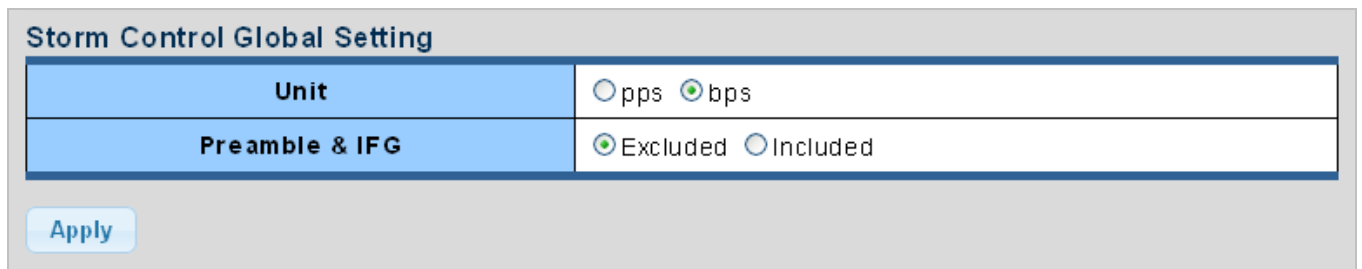

The screenshot shows the 'Storm Control Global Setting' configuration page. It features two main settings:

- Unit:** Radio buttons for 'pps' and 'bps'. The 'bps' option is selected.
- Preamble & IFG:** Radio buttons for 'Excluded' and 'Included'. The 'Excluded' option is selected.

An 'Apply' button is located at the bottom left of the configuration area.

Figure 4-9-69 Storm Control Global Setting Page Screenshot

The page includes the following fields:

| Object | Description |
|------------------|--|
| • Unit | Controls the unit of measure for the storm control rate as "pps" or "bps". The default value is "bps". |
| • Preamble & IFG | Set the excluded or included interframe gap |

Buttons

: Click to apply changes.

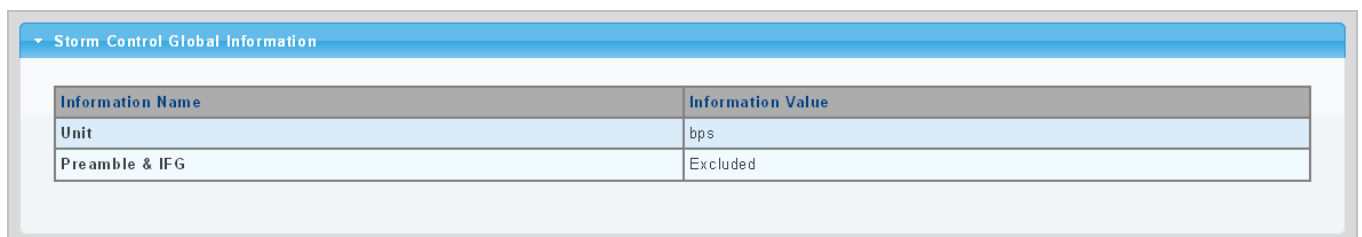

The screenshot shows the 'Storm Control Global Information' page, which displays the current configuration values in a table:

| Information Name | Information Value |
|------------------|-------------------|
| Unit | bps |
| Preamble & IFG | Excluded |

Figure 4-9-70 Storm Control Global Information Page Screenshot

The page includes the following fields:

| Object | Description |
|------------------|------------------------------------|
| • Unit | Display the current unit |
| • Preamble & IFG | Display the current preamble & IFG |

4.9.12.2 Port Setting

Storm control for the switch is configured on this page. There are three types of storm rate control:

- **Broadcast** storm rate control
- **Unknown Unicast** storm rate control
- **Unknown Multicast** storm rate control

The configuration indicates the permitted packet rate for unknown unicast, unknown multicast, or broadcast traffic across the switch. The Storm Control Configuration screens in [Figure 4-9-71](#) & [Figure 4-9-72](#) appear.

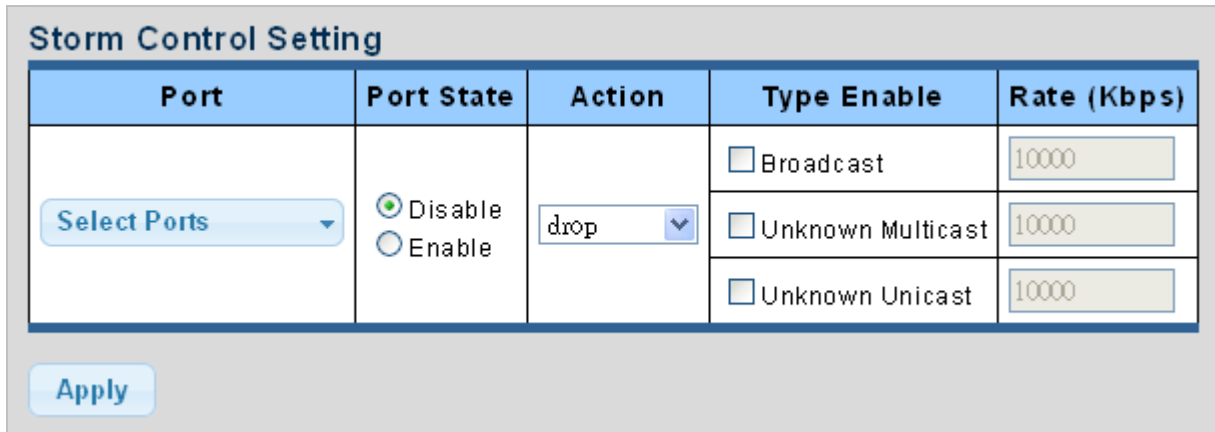

| Port | Port State | Action | Type Enable | Rate (Kbps) |
|--------------|--|--------|--|-------------|
| Select Ports | <input checked="" type="radio"/> Disable <input type="radio"/> Enable | drop | <input type="checkbox"/> Broadcast | 10000 |
| | | | <input type="checkbox"/> Unknown Multicast | 10000 |
| | | | <input type="checkbox"/> Unknown Unicast | 10000 |

Apply

Figure 4-9-71 Storm Control Setting Page Screenshot

The page includes the following fields:

| Object | Description |
|--------------------------|--|
| • Port | Select port for this drop-down list. |
| • Port State | Enable or disable the storm control status for the given storm type. |
| • Action | Configures the action performed when storm control is over rate on a port. Valid values are Shutdown or Drop . |
| • Type Enable | The settings in a particular row apply to the frame type listed here: <ul style="list-style-type: none"> ■ broadcast ■ unknown unicast ■ unknown multicast |
| • Rate (kbps/pps) | Configure the rate for the storm control. The default value is "10,000". |

Buttons

: Click to apply changes

| Storm Control Information | | | | | |
|---------------------------|------------|------------------|--------------------------|------------------------|--------|
| Port | Port State | Broadcast (Kbps) | Unknown Multicast (Kbps) | Unknown Unicast (Kbps) | Action |
| GE1 | disabled | Off (10000) | Off (10000) | Off (10000) | Drop |
| GE2 | disabled | Off (10000) | Off (10000) | Off (10000) | Drop |
| GE3 | disabled | Off (10000) | Off (10000) | Off (10000) | Drop |
| GE4 | disabled | Off (10000) | Off (10000) | Off (10000) | Drop |
| GE5 | disabled | Off (10000) | Off (10000) | Off (10000) | Drop |
| GE6 | disabled | Off (10000) | Off (10000) | Off (10000) | Drop |
| GE7 | disabled | Off (10000) | Off (10000) | Off (10000) | Drop |
| GE8 | disabled | Off (10000) | Off (10000) | Off (10000) | Drop |
| GE9 | disabled | Off (10000) | Off (10000) | Off (10000) | Drop |
| GE10 | disabled | Off (10000) | Off (10000) | Off (10000) | Drop |

Figure 4-9-72 Storm Control Information Page Screenshot

The page includes the following fields:

| Object | Description |
|--------------------------------|--|
| • Port | The switch port number of the logical port |
| • Port State | Display the current port state |
| • Broadcast (Kbps/pps) | Display the current broadcast storm control rate |
| • Unknown Multicast (Kbps/pps) | Display the current unknown multicast storm control rate |
| • Unknown Unicast (Kbps/pps) | Display the current unknown unicast storm control rate |
| • Action | Display the current action |

4.10 ACL

ACL is an acronym for **Access Control List**. It is the list table of ACEs, containing access control entries that specify individual users or groups permitted or denied to specific traffic objects, such as a process or a program. Each accessible traffic object contains an identifier to its ACL. The privileges determine whether there are specific traffic object access rights.

ACL implementations can be quite complex, for example, when the ACEs are prioritized for the various situation. In networking, the ACL refers to a list of service ports or network services that are available on a host or server, each with a list of hosts or servers permitted or denied to use the service. ACL can generally be configured to control inbound traffic, and in this context, they are similar to firewalls.

ACE is an acronym for **Access Control Entry**. It describes access permission associated with a particular ACE ID. There are three ACE frame types (Ethernet Type, ARP, and IPv4) and two ACE actions (permit and deny). The ACE also contains many detailed, different parameter options that are available for individual application.

The ACL page contains links to the following main topics:

- **MAC-based ACL** Configure MAC-based ACL setting
- **MAC-based ACE** Add / Edit / Delete the MAC-based ACE (Access Control Entry) setting
- **IPv4-based ACL** Configure IPv4-based ACL setting
- **IPv4-based ACE** Add / Edit / Delete the IPv4-based ACE (Access Control Entry) setting
- **IPv6-based ACL** Configure IPv6-based ACL setting
- **IPv6-based ACE** Add / Edit / Delete the IPv6-based ACE (Access Control Entry) setting
- **ACL Binding** Configure the ACL parameters (ACE) of each switch port.

4.10.1 MAC-based ACL

This page shows the ACL status by different ACL users. Each row describes the ACE that is defined. It is a conflict if a specific ACE is not applied to the hardware due to hardware limitations. MAC-based ACL screens in [Figure 4-10-1](#) & [Figure 4-10-2](#) appear.



Figure 4-10-1 MAC-based ACL Page Screenshot

The page includes the following fields:

| Object | Description |
|-------------------|---------------------------------------|
| • ACL Name | Create a name from MAC-based ACL list |

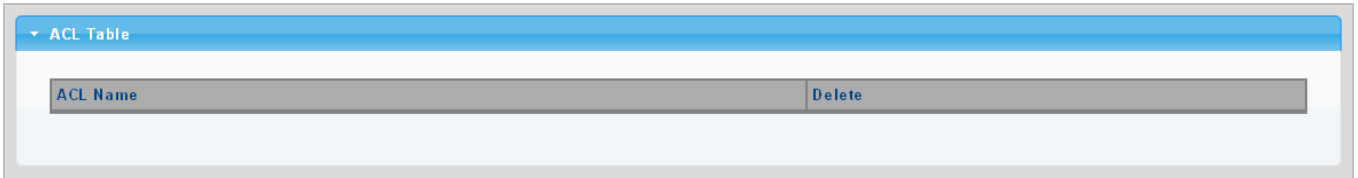

Figure 4-10-2 ACL Table Page Screenshot

The page includes the following fields:

| Object | Description |
|--|--|
| <ul style="list-style-type: none"> Delete | Click <input type="button" value="Delete"/> to delete ACL name entry |

4.10.2 MAC-based ACE

An ACE consists of several parameters. Different parameter options are displayed depending on the frame type that you select.

The MAC-based ACE screens in [Figure 4-10-3](#) & [Figure 4-10-4](#) appear.

MAC-Based ACE

| | |
|---|---|
| ACL Name | <input type="text"/> |
| Sequence | <input type="text"/> (Range: 1 - 2147483647, 1 is first processed) |
| Action | <input checked="" type="radio"/> Permit <input type="radio"/> Deny <input type="radio"/> Shutdown |
| DA MAC | <input checked="" type="radio"/> Any <input type="radio"/> User Defined |
| DA MAC Value | <input type="text"/> |
| DA MAC Mask | <input type="text"/> (0s for matching, 1s for no matching) |
| SA MAC | <input checked="" type="radio"/> Any <input type="radio"/> User Defined |
| SA MAC Value | <input type="text"/> |
| SA MAC Mask | <input type="text"/> (0s for matching, 1s for no matching) |
| VLAN ID | <input type="text"/> (Range: 1 - 4094) |
| 802.1p | <input type="checkbox"/> Include |
| 802.1p Value | <input type="text"/> (Range: 0-7) |
| 802.1p Mask | <input type="text"/> |
| Ethertype (Range: 0x05DD-0xFFFF) | <input type="text"/> (Range: 0x05DD-0xFFFF) |

Figure 4-10-3 MAC-based ACE Page Screenshot

The page includes the following fields:

| Object | Description |
|---|--|
| • ACL Name | Select ACL name from this drop-down list |
| • Sequence | Set the ACL sequence |
| • Action | Indicates the forwarding action of the ACE. <ul style="list-style-type: none"> ■ Permit: Frames matching the ACE may be forwarded and learned. ■ Deny: Frames matching the ACE are dropped. ■ Shutdown: Port shutdown is disabled for the ACE. |
| • DA MAC | Specify the destination MAC filter for this ACE. <ul style="list-style-type: none"> ■ Any: No DA MAC filter is specified. ■ User Defined: If you want to filter a specific destination MAC address with this ACE, choose this value. A field for entering a DA MAC value appears. |
| • DA MAC Value | When "User Defined" is selected for the DA MAC filter, you can enter a specific destination MAC address. The legal format is "xx-xx-xx-xx-xx-xx". A frame that hits this ACE matches this DA MAC value. |
| • DA MAC Mask | Specify whether frames can hit the action according to their sender hardware address field (SHA) settings. <ul style="list-style-type: none"> ■ 0: ARP frames where SHA is not equal to the DA MAC address. ■ 1: ARP frames where SHA is equal to the DA MAC address. |
| • SA MAC | Specify the source MAC filter for this ACE. <ul style="list-style-type: none"> ■ Any: No SA MAC filter is specified. ■ User Defined: If you want to filter a specific source MAC address with this ACE, choose this value. A field for entering a SA MAC value appears. |
| • SA MAC Value | When "User Defined" is selected for the SA MAC filter, you can enter a specific source MAC address. The legal format is "xx-xx-xx-xx-xx-xx". A frame that hits this ACE matches this SA MAC value. |
| • SA MAC Mask | Specify whether frames can hit the action according to their sender hardware address field (SHA) settings. <ul style="list-style-type: none"> ■ 0: ARP frames where SHA is not equal to the SA MAC address. ■ 1: ARP frames where SHA is equal to the SA MAC address. |
| • VLAN ID | Indicates the ID of this particular VLAN |
| • 802.1p | Include or exclude the 802.1p value |
| • 802.1p Value | Set the 802.1p value |
| • 802.1p Mask | <ul style="list-style-type: none"> ■ 0: where frame is not equal to the 802.1p value. ■ 1: where frame is equal to the 802.1p value. |
| • EtherType (Range:0x05DD – 0xFFFF) | You can enter a specific EtherType value. The allowed range is 0x05DD to 0xFFFF . A frame that hits this ACE matches this EtherType value. |

Buttons

 : Click to add ACE list.

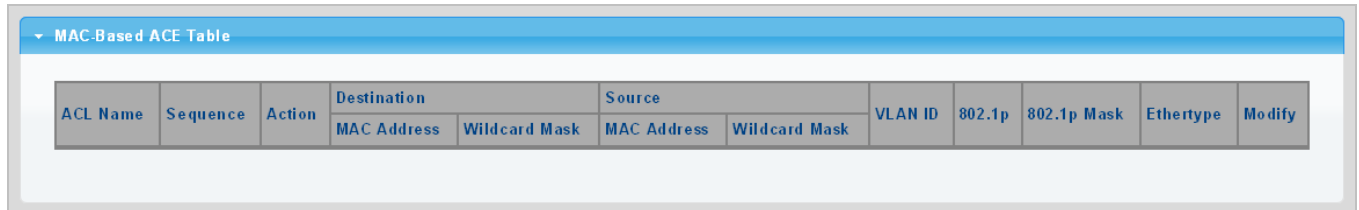



Figure 4-10-4 MAC-based ACE Table Page Screenshot

The page includes the following fields:

| Object | Description |
|---------------------------------------|--|
| • ACL Name | Display the current ACL name |
| • Sequence | Display the current sequence |
| • Action | Display the current action |
| • Destination MAC Address | Display the current destination MAC address |
| • Destination MAC Address Mask | Display the current destination MAC address mask |
| • Source MAC Address | Display the current source MAC address |
| • Source MAC Address Mask | Display the current source MAC address mask |
| • VLAN ID | Display the current VLAN ID |
| • 802.1p | Display the current 802.1p value |
| • 802.1p Mask | Display the current 802.1p mask |
| • EtherType | Display the current EtherType |
| • Modify | Click  to edit MAC-based ACL parameter Click  to delete MAC-based ACL entry |

4.10.3 IPv4-based ACL

This page shows the ACL status by different ACL users. Each row describes the ACE that is defined. It is a conflict if a specific ACE is not applied to the hardware due to hardware limitations. IPv4-based ACL screens in [Figure 4-10-5](#) & [Figure 4-10-6](#) appear.



Figure 4-10-5 IPv4-based ACL Page Screenshot

The page includes the following fields:

| Object | Description |
|--|--|
| <ul style="list-style-type: none"> ACL Name | Create a name from IPv4-based ACL list |

Buttons



: Click to add ACL name list.

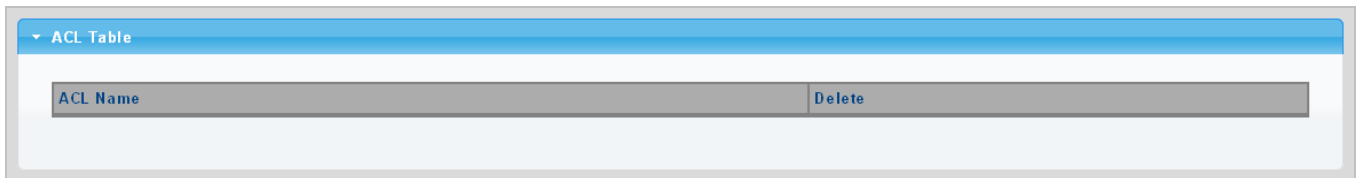



Figure 4-10-6 ACL Table Page Screenshot

The page includes the following fields:

| Object | Description |
|--|---|
| <ul style="list-style-type: none"> Delete | Click  to delete ACL name entry. |

4.10.4 IPv4-based ACE

An ACE consists of several parameters. Different parameter options are displayed depending on the frame type that you select. The IPv4-based ACE screens in [Figure 4-10-7](#) & [Figure 4-10-8](#) appear.

IPv4-Based ACE

| | |
|-------------------------------------|--|
| ACL Name | <input type="text" value=""/> |
| Sequence | <input type="text" value=""/> (Range: 1 - 2147483647, 1 is first processed) |
| Action | <input checked="" type="radio"/> Permit <input type="radio"/> Deny <input type="radio"/> Shutdown |
| Protocol | <input checked="" type="radio"/> Any(IP) <input type="radio"/> Select from list <input type="text" value="icmp"/> <input type="radio"/> Protocol ID to match <input type="text" value="1"/> |
| Source IP Address | <input checked="" type="radio"/> Any <input type="radio"/> User Defined |
| Source IP Address Value | <input type="text" value=""/> |
| Source IP Wildcard Mask | <input type="text" value=""/> (0s for matching, 1s for no matching) |
| Destination IP Address | <input checked="" type="radio"/> Any <input type="radio"/> User Defined |
| Destination IP Address Value | <input type="text" value=""/> |
| Destination IP Wildcard Mask | <input type="text" value=""/> (0s for matching, 1s for no matching) |
| Source Port | <input checked="" type="radio"/> Any <input type="radio"/> Single <input type="text" value="0"/> (Range: 0 - 65535) <input type="radio"/> Range <input type="text" value="0"/> - <input type="text" value="65535"/> (Range: 0 - 65535) |
| Destination Port | <input checked="" type="radio"/> Any <input type="radio"/> Single(Range: 0 - 65535) <input type="text" value="0"/> (Range: 0 - 65535) <input type="radio"/> Range(Range: 0 - 65535) <input type="text" value="0"/> - <input type="text" value="65535"/> (Range: 0 - 65535) |
| TCP Flags | Urg <input checked="" type="radio"/> Set <input type="radio"/> Unset <input type="radio"/> Don't Care Ack <input checked="" type="radio"/> Set <input type="radio"/> Unset <input type="radio"/> Don't Care Psh <input checked="" type="radio"/> Set <input type="radio"/> Unset <input type="radio"/> Don't Care Rst <input checked="" type="radio"/> Set <input type="radio"/> Unset <input type="radio"/> Don't Care Syn <input checked="" type="radio"/> Set <input type="radio"/> Unset <input type="radio"/> Don't Care Fin <input checked="" type="radio"/> Set <input type="radio"/> Unset <input type="radio"/> Don't Care |
| Type of Service | <input checked="" type="radio"/> Any <input type="radio"/> DSCP to match <input type="text" value="0"/> (Range: 0 - 63) <input type="radio"/> IP Precedence to match <input type="text" value="0"/> (Range: 0 - 7) |
| ICMP | <input checked="" type="radio"/> Any <input type="radio"/> Select from list <input type="text" value="Echo Reply"/> <input type="radio"/> Protocol ID to match <input type="text" value="0"/> (Range: 0 - 255) |
| ICMP Code | <input checked="" type="radio"/> Any <input type="radio"/> User Defined <input type="text" value="0"/> (Range: 0 - 255) |

Add

Figure 4-10-7 IP-based ACE Page Screenshot

The page includes the following fields:

| Object | Description |
|---------------------------------------|--|
| • ACL Name | Select ACL name from this drop-down list. |
| • Sequence | Set the ACL sequence. |
| • Action | Indicates the forwarding action of the ACE. <ul style="list-style-type: none"> ■ Permit: Frames matching the ACE may be forwarded and learned. ■ Deny: Frames matching the ACE are dropped. ■ Shutdown: Port shutdown is disabled for the ACE. |
| • Protocol | Specify the protocol filter for this ACE. <ul style="list-style-type: none"> ■ Any(IP): No protocol filter is specified. ■ Select from list: If you want to filter a specific protocol with this ACE, choose this value and select protocol for this drop down list. ■ Protocol ID to match: If you want to filter a specific protocol with this ACE, choose this value and set correct protocol ID. |
| • Source IP Address | Specify the Source IP address filter for this ACE. <ul style="list-style-type: none"> ■ Any: No source IP address filter is specified. ■ User Defined: If you want to filter a specific source IP address with this ACE, choose this value. A field for entering a source IP address value appears. |
| • Source IP Address Value | When "User Defined" is selected for the source IP address filter, you can enter a specific source IP address. The legal format is "xxx.xxx.xxx.xxx". A frame that hits this ACE matches this source IP address value. |
| • Source IP Wildcard Mask | When "User Defined" is selected for the source IP filter, you can enter a specific SIP mask in dotted decimal notation. |
| • Destination IP Address | Specify the Destination IP address filter for this ACE. <ul style="list-style-type: none"> ■ Any: No destination IP address filter is specified. ■ User Defined: If you want to filter a specific destination IP address with this ACE, choose this value. A field for entering a source IP address value appears. |
| • Destination IP Address Value | When "User Defined" is selected for the destination IP address filter, you can enter a specific destination IP address. The legal format is "xxx.xxx.xxx.xxx". A frame that hits this ACE matches this destination IP address value. |
| • Destination IP Wildcard Mask | When "User Defined" is selected for the destination IP filter, you can enter a specific DIP mask in dotted decimal notation. |
| • Source Port | Specify the source port for this ACE. <ul style="list-style-type: none"> ■ Any: No specific source port is specified (source port status is "don't-care"). ■ Single: If you want to filter a specific source port with this ACE, you can enter a specific source port value. A field for entering a source port value appears. The allowed range is 0 to 65535. A frame that hits this ACE matches this source port value. |

| | | | | | | | | | |
|---|--|-----|---|-----|---|-----|--|-----|---|
| | <ul style="list-style-type: none"> ■ Range: If you want to filter a specific source port range filter with this ACE, you can enter a specific source port range value. A field for entering a source port value appears. The allowed range is 0 to 65535. A frame that hits this ACE matches this source port value. | | | | | | | | |
| <ul style="list-style-type: none"> • Destination Port | <p>Specify the destination port for this ACE.</p> <ul style="list-style-type: none"> ■ Any: No specific destination port is specified (destination port status is "don't-care"). ■ Single: If you want to filter a specific destination port with this ACE, you can enter a specific destination port value. A field for entering a destination port value appears. The allowed range is 0 to 65535. A frame that hits this ACE matches this destination port value. ■ Range: If you want to filter a specific destination port range filter with this ACE, you can enter a specific destination port range value. A field for entering a destination port value appears. | | | | | | | | |
| <ul style="list-style-type: none"> • TCP Flags | <table border="1"> <tr> <td data-bbox="523 853 624 1144">UGR</td> <td data-bbox="624 853 1473 1144"> <p>Specify the TCP "Urgent Pointer field significant" (URG) value for this ACE.</p> <ul style="list-style-type: none"> ■ Set: TCP frames where the URG field is set must be able to match this entry. ■ Unset: TCP frames where the URG field is set must not be able to match this entry. ■ Don't Care: Any value is allowed ("don't-care"). </td> </tr> <tr> <td data-bbox="523 1144 624 1480">ACK</td> <td data-bbox="624 1144 1473 1480"> <p>Specify the TCP "Acknowledgment field significant" (ACK) value for this ACE.</p> <ul style="list-style-type: none"> ■ Set: TCP frames where the ACK field is set must be able to match this entry. ■ Unset: TCP frames where the ACK field is set must not be able to match this entry. ■ Don't Care: Any value is allowed ("don't-care"). </td> </tr> <tr> <td data-bbox="523 1480 624 1771">PSH</td> <td data-bbox="624 1480 1473 1771"> <p>Specify the TCP "Push Function" (PSH) value for this ACE.</p> <ul style="list-style-type: none"> ■ Set: TCP frames where the PSH field is set must be able to match this entry. ■ Unset: TCP frames where the PSH field is set must not be able to match this entry. ■ Don't Care: Any value is allowed ("don't-care"). </td> </tr> <tr> <td data-bbox="523 1771 624 2054">RST</td> <td data-bbox="624 1771 1473 2054"> <ul style="list-style-type: none"> ■ Specify the TCP "Reset the connection" (RST) value for this ACE. ■ Set: TCP frames where the RST field is set must be able to match this entry. ■ Unset: TCP frames where the RST field is set must not be able to match this entry. ■ Don't Care: Any value is allowed ("don't-care"). </td> </tr> </table> | UGR | <p>Specify the TCP "Urgent Pointer field significant" (URG) value for this ACE.</p> <ul style="list-style-type: none"> ■ Set: TCP frames where the URG field is set must be able to match this entry. ■ Unset: TCP frames where the URG field is set must not be able to match this entry. ■ Don't Care: Any value is allowed ("don't-care"). | ACK | <p>Specify the TCP "Acknowledgment field significant" (ACK) value for this ACE.</p> <ul style="list-style-type: none"> ■ Set: TCP frames where the ACK field is set must be able to match this entry. ■ Unset: TCP frames where the ACK field is set must not be able to match this entry. ■ Don't Care: Any value is allowed ("don't-care"). | PSH | <p>Specify the TCP "Push Function" (PSH) value for this ACE.</p> <ul style="list-style-type: none"> ■ Set: TCP frames where the PSH field is set must be able to match this entry. ■ Unset: TCP frames where the PSH field is set must not be able to match this entry. ■ Don't Care: Any value is allowed ("don't-care"). | RST | <ul style="list-style-type: none"> ■ Specify the TCP "Reset the connection" (RST) value for this ACE. ■ Set: TCP frames where the RST field is set must be able to match this entry. ■ Unset: TCP frames where the RST field is set must not be able to match this entry. ■ Don't Care: Any value is allowed ("don't-care"). |
| UGR | <p>Specify the TCP "Urgent Pointer field significant" (URG) value for this ACE.</p> <ul style="list-style-type: none"> ■ Set: TCP frames where the URG field is set must be able to match this entry. ■ Unset: TCP frames where the URG field is set must not be able to match this entry. ■ Don't Care: Any value is allowed ("don't-care"). | | | | | | | | |
| ACK | <p>Specify the TCP "Acknowledgment field significant" (ACK) value for this ACE.</p> <ul style="list-style-type: none"> ■ Set: TCP frames where the ACK field is set must be able to match this entry. ■ Unset: TCP frames where the ACK field is set must not be able to match this entry. ■ Don't Care: Any value is allowed ("don't-care"). | | | | | | | | |
| PSH | <p>Specify the TCP "Push Function" (PSH) value for this ACE.</p> <ul style="list-style-type: none"> ■ Set: TCP frames where the PSH field is set must be able to match this entry. ■ Unset: TCP frames where the PSH field is set must not be able to match this entry. ■ Don't Care: Any value is allowed ("don't-care"). | | | | | | | | |
| RST | <ul style="list-style-type: none"> ■ Specify the TCP "Reset the connection" (RST) value for this ACE. ■ Set: TCP frames where the RST field is set must be able to match this entry. ■ Unset: TCP frames where the RST field is set must not be able to match this entry. ■ Don't Care: Any value is allowed ("don't-care"). | | | | | | | | |

| | | |
|--|-----|---|
| | SYN | <p>Specify the TCP "Synchronize sequence numbers" (SYN) value for this ACE.</p> <ul style="list-style-type: none"> ■ Set: TCP frames where the SYN field is set must be able to match this entry. ■ Unset: TCP frames where the SYN field is set must not be able to match this entry. ■ Don't Care: Any value is allowed ("don't-care"). |
| | FIN | <p>Specify the TCP "No more data from sender" (FIN) value for this ACE.</p> <ul style="list-style-type: none"> ■ Set: TCP frames where the FIN field is set must be able to match this entry. ■ Unset: TCP frames where the FIN field is set must not be able to match this entry. ■ Don't Care: Any value is allowed ("don't-care"). |
| <ul style="list-style-type: none"> • Type of Service | | <p>Specify the type of service for this ACE.</p> <ul style="list-style-type: none"> ■ Any: No specific type of service is specified (destination port status is "don't-care"). ■ DSCP: If you want to filter a specific DSCP with this ACE, you can enter a specific DSCP value. A field for entering a DSCP value appears. The allowed range is 0 to 63. A frame that hits this ACE matches this DSCP value. ■ IP Precedence: If you want to filter a specific IP precedence with this ACE, you can enter a specific IP precedence value. A field for entering an IP precedence value appears. The allowed range is 0 to 7. A frame that hits this ACE matches this IP precedence value. |
| <ul style="list-style-type: none"> • ICMP | | <p>Specify the ICMP for this ACE.</p> <ul style="list-style-type: none"> ■ Any: No specific ICMP is specified (destination port status is "don't-care"). ■ List: If you want to filter a specific list with this ACE, you can select a specific list value. ■ Protocol ID: If you want to filter a specific protocol ID filter with this ACE, you can enter a specific protocol ID value. A field for entering a protocol ID value appears. The allowed range is 0 to 255. A frame that hits this ACE matches this protocol ID value. |
| <ul style="list-style-type: none"> • ICMP Code | | <p>Specify the ICMP code filter for this ACE.</p> <ul style="list-style-type: none"> ■ Any: No ICMP code filter is specified (ICMP code filter status is "don't-care"). ■ User Defined: If you want to filter a specific ICMP code filter with this ACE, you can enter a specific ICMP code value. A field for entering an ICMP code value appears. The allowed range is 0 to 255. A frame that hits this ACE matches this ICMP code value. |

Add : Click to add ACE list.

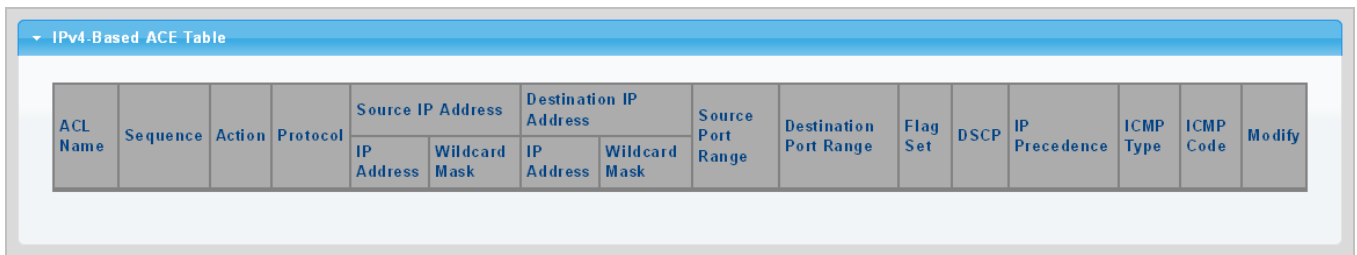

Figure 4-10-8 IPv4-based ACE Table Page Screenshot

The page includes the following fields:

| Object | Description |
|---|--|
| • ACL Name | Display the current ACL name |
| • Sequence | Display the current sequence |
| • Action | Display the current action |
| • Protocol | Display the current protocol |
| • Source IP Address | Display the current source IP address |
| • Source IP Address Wildcard Mask | Display the current source IP address wildcard mask |
| • Destination IP Address | Display the current destination IP address |
| • Destination IP Address Wildcard Mask | Display the current destination IP address wildcard mask |
| • Source Port Range | Display the current source port range |
| • Destination Port Range | Display the current destination port range |
| • Flag Set | Display the current flag set |
| • DSCP | Display the current DSCP |
| • IP Precedence | Display the current IP precedence |
| • ICMP Type | Display the current ICMP Type |
| • ICMP Code | Display the current ICMP code |
| • Modify | Click Edit to edit IPv4-based ACL parameter Click Delete to delete IPv4-based ACL entry |

4.10.5 IPv6-based ACL

This page shows the ACL status by different ACL users. Each row describes the ACE that is defined. It is a conflict if a specific ACE is not applied to the hardware due to hardware limitations. IPv6-based ACL screens in [Figure 4-10-9](#) & [Figure 4-10-10](#) appear.



Figure 4-10-9 IPv6-based ACL Page Screenshot

The page includes the following fields:

| Object | Description |
|--|--|
| <ul style="list-style-type: none"> ACL Name | Create a name from IPv6-based ACL list |

Buttons



: Click to add ACL name list.

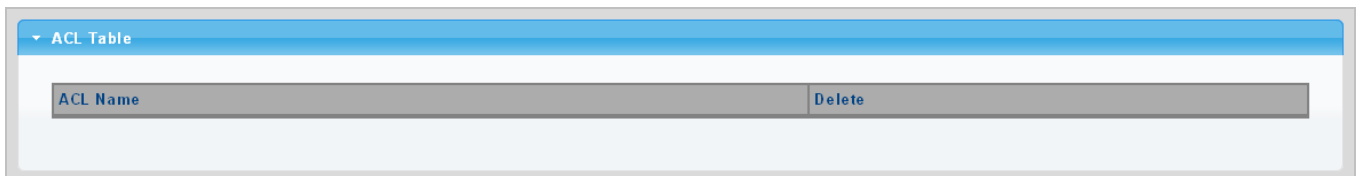



Figure 4-10-10 ACL Table Page Screenshot

The page includes the following fields:

| Object | Description |
|--|--|
| <ul style="list-style-type: none"> Delete | Click  to delete ACL name entry |

4.10.6 IPv6-based ACE

An ACE consists of several parameters. Different parameter options are displayed depending on the frame type that you select. The IPv6-based ACE screens in [Figure 4-10-11](#) & [Figure 4-10-12](#) appear.

IPv6-Based ACE

| | |
|-------------------------------------|--|
| ACL Name | <input type="text" value=""/> |
| Sequence | <input type="text" value=""/> (Range: 1 - 2147483647, 1 is first processed) |
| Action | <input checked="" type="radio"/> Permit <input type="radio"/> Deny <input type="radio"/> Shutdown |
| Protocol | <input checked="" type="radio"/> Any(IP) <input type="radio"/> Select from list <input type="text" value="tcp"/> |
| Source IP Address | <input checked="" type="radio"/> Any <input type="radio"/> User Defined |
| Source IP Address Value | <input type="text" value=""/> |
| Source IP Prefix Length | <input type="text" value="0"/> (Range: 0 - 128) |
| Destination IP Address | <input checked="" type="radio"/> Any <input type="radio"/> User Defined |
| Destination IP Address Value | <input type="text" value=""/> |
| Destination IP Prefix Length | <input type="text" value="0"/> (0s for matching, 1s for no matching) |
| Source Port | <input checked="" type="radio"/> Any <input type="radio"/> Single <input type="text" value="0"/> (Range: 0 - 65535) <input type="radio"/> Range <input type="text" value="0"/> - <input type="text" value="65535"/> (Range: 0 - 65535) |
| Destination Port | <input checked="" type="radio"/> Any <input type="radio"/> Single(Range: 0 - 65535) <input type="text" value="0"/> (Range: 0 - 65535) <input type="radio"/> Range(Range: 0 - 65535) <input type="text" value="0"/> - <input type="text" value="65535"/> (Range: 0 - 65535) |
| TCP Flags | Urg <input checked="" type="radio"/> Set <input type="radio"/> Unset <input type="radio"/> Don't Care Ack <input checked="" type="radio"/> Set <input type="radio"/> Unset <input type="radio"/> Don't Care Psh <input checked="" type="radio"/> Set <input type="radio"/> Unset <input type="radio"/> Don't Care Rst <input checked="" type="radio"/> Set <input type="radio"/> Unset <input type="radio"/> Don't Care Syn <input checked="" type="radio"/> Set <input type="radio"/> Unset <input type="radio"/> Don't Care Fin <input checked="" type="radio"/> Set <input type="radio"/> Unset <input type="radio"/> Don't Care |
| Type of Service | <input checked="" type="radio"/> Any <input type="radio"/> DSCP to match <input type="text" value="0"/> (Range: 0 - 63) <input type="radio"/> IP Precedence to match <input type="text" value="0"/> (Range: 0 - 7) |
| ICMP | <input checked="" type="radio"/> Any <input type="radio"/> Select from list <input type="text" value="destination"/> <input type="radio"/> Protocol ID to match <input type="text" value="0"/> (Range: 0 - 255) |
| ICMP Code | <input checked="" type="radio"/> Any <input type="radio"/> User Defined <input type="text" value="0"/> (Range: 0 - 255) |

Figure 4-10-11 IP-based ACE Page Screenshot

The page includes the following fields:

| Object | Description |
|---------------------------------------|--|
| • ACL Name | Select ACL name from this drop-down list |
| • Sequence | Set the ACL sequence |
| • Action | Indicates the forwarding action of the ACE <ul style="list-style-type: none"> ■ Permit: Frames matching the ACE may be forwarded and learned. ■ Deny: Frames matching the ACE are dropped. ■ Shutdown: Port shutdown is disabled for the ACE. |
| • Protocol | Specify the protocol filter for this ACE <ul style="list-style-type: none"> ■ Any(IP): No protocol filter is specified. ■ Select from list: If you want to filter a specific protocol with this ACE, choose this value and select protocol for this drop down list. |
| • Source IP Address | Specify the Source IP address filter for this ACE <ul style="list-style-type: none"> ■ Any: No source IP address filter is specified. ■ User Defined: If you want to filter a specific source IP address with this ACE, choose this value. A field for entering a source IP address value appears. |
| • Source IP Address Value | When "User Defined" is selected for the source IP address filter, you can enter a specific source IP address. The legal format is "xxxx:xxx:xxx:xxx:xxx:xxx:xxx:xxx:xxx:xxx". A frame that hits this ACE matches this source IP address value. |
| • Source IP Prefix Length | When "User Defined" is selected for the source IP filter, you can enter a specific SIP prefix length in dotted decimal notation. |
| • Destination IP Address | Specify the Destination IP address filter for this ACE. <ul style="list-style-type: none"> ■ Any: No destination IP address filter is specified. ■ User Defined: If you want to filter a specific destination IP address with this ACE, choose this value. A field for entering a source IP address value appears. |
| • Destination IP Address Value | When "User Defined" is selected for the destination IP address filter, you can enter a specific destination IP address. The legal format is " xxx:xxx:xxx:xxx:xxx:xxx:xxx:xxx:xxx:xxx ". A frame that hits this ACE matches this destination IP address value. |
| • Destination IP Prefix Length | When "User Defined" is selected for the destination IP filter, you can enter a specific DIP prefix length in dotted decimal notation. |
| • Source Port | Specify the source port for this ACE. <ul style="list-style-type: none"> ■ Any: No specific source port is specified (source port status is "don't-care"). ■ Single: If you want to filter a specific source port with this ACE, you can enter a specific source port value. A field for entering a source port value appears. The allowed range is 0 to 65535. A frame that hits this ACE |

| | | | | | | | | | |
|---|---|-----|---|-----|---|-----|--|-----|--|
| | <p>matches this source port value.</p> <ul style="list-style-type: none"> ■ Range: If you want to filter a specific source port range filter with this ACE, you can enter a specific source port range value. A field for entering a source port value appears. The allowed range is 0 to 65535. A frame that hits this ACE matches this source port value. | | | | | | | | |
| <ul style="list-style-type: none"> • Destination Port | <p>Specify the destination port for this ACE.</p> <ul style="list-style-type: none"> ■ Any: No specific destination port is specified (destination port status is "don't-care"). ■ Single: If you want to filter a specific destination port with this ACE, you can enter a specific destination port value. A field for entering a destination port value appears. The allowed range is 0 to 65535. A frame that hits this ACE matches this destination port value. ■ Range: If you want to filter a specific destination port range filter with this ACE, you can enter a specific destination port range value. A field for entering a destination port value appears. | | | | | | | | |
| <ul style="list-style-type: none"> • TCP Flags | <table border="1"> <tr> <td data-bbox="523 898 625 1234">UGR</td> <td data-bbox="625 898 1410 1234"> <p>Specify the TCP "Urgent Pointer field significant" (URG) value for this ACE.</p> <ul style="list-style-type: none"> ■ Set: TCP frames where the URG field is set must be able to match this entry. ■ Unset: TCP frames where the URG field is set must not be able to match this entry. ■ Don't Care: Any value is allowed ("don't-care"). </td> </tr> <tr> <td data-bbox="523 1234 625 1570">ACK</td> <td data-bbox="625 1234 1410 1570"> <p>Specify the TCP "Acknowledgment field significant" (ACK) value for this ACE.</p> <ul style="list-style-type: none"> ■ Set: TCP frames where the ACK field is set must be able to match this entry. ■ Unset: TCP frames where the ACK field is set must not be able to match this entry. ■ Don't Care: Any value is allowed ("don't-care"). </td> </tr> <tr> <td data-bbox="523 1570 625 1861">PSH</td> <td data-bbox="625 1570 1410 1861"> <p>Specify the TCP "Push Function" (PSH) value for this ACE.</p> <ul style="list-style-type: none"> ■ Set: TCP frames where the PSH field is set must be able to match this entry. ■ Unset: TCP frames where the PSH field is set must not be able to match this entry. ■ Don't Care: Any value is allowed ("don't-care"). </td> </tr> <tr> <td data-bbox="523 1861 625 2054">RST</td> <td data-bbox="625 1861 1410 2054"> <p>Specify the TCP "Reset the connection" (RST) value for this ACE.</p> <ul style="list-style-type: none"> ■ Set: TCP frames where the RST field is set must be able to match this entry. ■ Unset: TCP frames where the RST field is set must not be able to </td> </tr> </table> | UGR | <p>Specify the TCP "Urgent Pointer field significant" (URG) value for this ACE.</p> <ul style="list-style-type: none"> ■ Set: TCP frames where the URG field is set must be able to match this entry. ■ Unset: TCP frames where the URG field is set must not be able to match this entry. ■ Don't Care: Any value is allowed ("don't-care"). | ACK | <p>Specify the TCP "Acknowledgment field significant" (ACK) value for this ACE.</p> <ul style="list-style-type: none"> ■ Set: TCP frames where the ACK field is set must be able to match this entry. ■ Unset: TCP frames where the ACK field is set must not be able to match this entry. ■ Don't Care: Any value is allowed ("don't-care"). | PSH | <p>Specify the TCP "Push Function" (PSH) value for this ACE.</p> <ul style="list-style-type: none"> ■ Set: TCP frames where the PSH field is set must be able to match this entry. ■ Unset: TCP frames where the PSH field is set must not be able to match this entry. ■ Don't Care: Any value is allowed ("don't-care"). | RST | <p>Specify the TCP "Reset the connection" (RST) value for this ACE.</p> <ul style="list-style-type: none"> ■ Set: TCP frames where the RST field is set must be able to match this entry. ■ Unset: TCP frames where the RST field is set must not be able to |
| UGR | <p>Specify the TCP "Urgent Pointer field significant" (URG) value for this ACE.</p> <ul style="list-style-type: none"> ■ Set: TCP frames where the URG field is set must be able to match this entry. ■ Unset: TCP frames where the URG field is set must not be able to match this entry. ■ Don't Care: Any value is allowed ("don't-care"). | | | | | | | | |
| ACK | <p>Specify the TCP "Acknowledgment field significant" (ACK) value for this ACE.</p> <ul style="list-style-type: none"> ■ Set: TCP frames where the ACK field is set must be able to match this entry. ■ Unset: TCP frames where the ACK field is set must not be able to match this entry. ■ Don't Care: Any value is allowed ("don't-care"). | | | | | | | | |
| PSH | <p>Specify the TCP "Push Function" (PSH) value for this ACE.</p> <ul style="list-style-type: none"> ■ Set: TCP frames where the PSH field is set must be able to match this entry. ■ Unset: TCP frames where the PSH field is set must not be able to match this entry. ■ Don't Care: Any value is allowed ("don't-care"). | | | | | | | | |
| RST | <p>Specify the TCP "Reset the connection" (RST) value for this ACE.</p> <ul style="list-style-type: none"> ■ Set: TCP frames where the RST field is set must be able to match this entry. ■ Unset: TCP frames where the RST field is set must not be able to | | | | | | | | |

| | |
|--|--|
| | <p>match this entry.</p> <ul style="list-style-type: none"> ■ Don't Care: Any value is allowed ("don't-care"). |
| SYN | <p>Specify the TCP "Synchronize sequence numbers" (SYN) value for this ACE.</p> <ul style="list-style-type: none"> ■ Set: TCP frames where the SYN field is set must be able to match this entry. ■ Unset: TCP frames where the SYN field is set must not be able to match this entry. ■ Don't Care: Any value is allowed ("don't-care"). |
| FIN | <p>Specify the TCP "No more data from sender" (FIN) value for this ACE.</p> <ul style="list-style-type: none"> ■ Set: TCP frames where the FIN field is set must be able to match this entry. ■ Unset: TCP frames where the FIN field is set must not be able to match this entry. ■ Don't Care: Any value is allowed ("don't-care"). |
| <ul style="list-style-type: none"> • Type of Service | <p>Specify the type of service for this ACE.</p> <ul style="list-style-type: none"> ■ Any: No specific type of service is specified (destination port status is "don't-care"). ■ DSCP: If you want to filter a specific DSCP with this ACE, you can enter a specific DSCP value. A field for entering a DSCP value appears. The allowed range is 0 to 63. A frame that hits this ACE matches this DSCP value. ■ IP Precedence: If you want to filter a specific IP precedence with this ACE, you can enter a specific IP precedence value. A field for entering a IP precedence value appears. The allowed range is 0 to 7. A frame that hits this ACE matches this IP precedence value. |
| <ul style="list-style-type: none"> • ICMP | <p>Specify the ICMP for this ACE.</p> <ul style="list-style-type: none"> ■ Any: No specific ICMP is specified (destination port status is "don't-care"). ■ List: If you want to filter a specific list with this ACE, you can select a specific list value. ■ Protocol ID: If you want to filter a specific protocol ID filter with this ACE, you can enter a specific protocol ID value. A field for entering a protocol ID value appears. The allowed range is 0 to 255. A frame that hits this ACE matches this protocol ID value. |
| <ul style="list-style-type: none"> • ICMP Code | <p>Specify the ICMP code filter for this ACE.</p> <ul style="list-style-type: none"> ■ Any: No ICMP code filter is specified (ICMP code filter status is "don't-care"). ■ User Defined: If you want to filter a specific ICMP code filter with this ACE, you can enter a specific ICMP code value. A field for entering an ICMP code value appears. The allowed range is 0 to 255. A frame that hits this ACE matches this ICMP code value. |

Buttons

 : Click to add ACE list

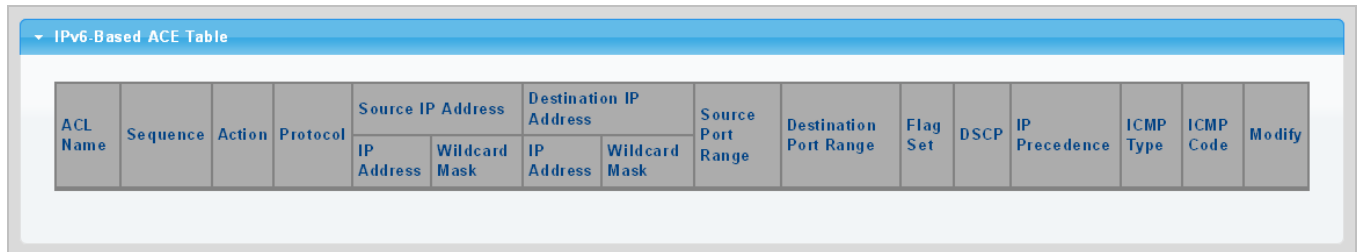



Figure 4-10-12 IPv6-based ACE Table Page Screenshot

The page includes the following fields:

| Object | Description |
|---|---|
| • ACL Name | Display the current ACL name |
| • Sequence | Display the current sequence |
| • Action | Display the current action |
| • Protocol | Display the current protocol |
| • Source IP Address | Display the current source IP address |
| • Source IP Address Wildcard Mask | Display the current source IP address wildcard mask |
| • Destination IP Address | Display the current destination IP address |
| • Destination IP Address Wildcard Mask | Display the current destination IP address wildcard mask |
| • Source Port Range | Display the current source port range |
| • Destination Port Range | Display the current destination port range |
| • Flag Set | Display the current flag set |
| • DSCP | Display the current DSCP |
| • IP Precedence | Display the current IP precedence |
| • ICMP Type | Display the current ICMP Type |
| • ICMP Code | Display the current ICMP code |
| • Modify | <p>Click  to edit IPv6-based ACL parameter.</p> <p>Click  to delete IPv6-based ACL entry.</p> |

4.10.7 ACL Binding

This page allows you to bind the Policy content to the appropriate ACLs. The ACL Policy screens in [Figure 4-10-13](#) & [Figure 4-10-14](#) appear.

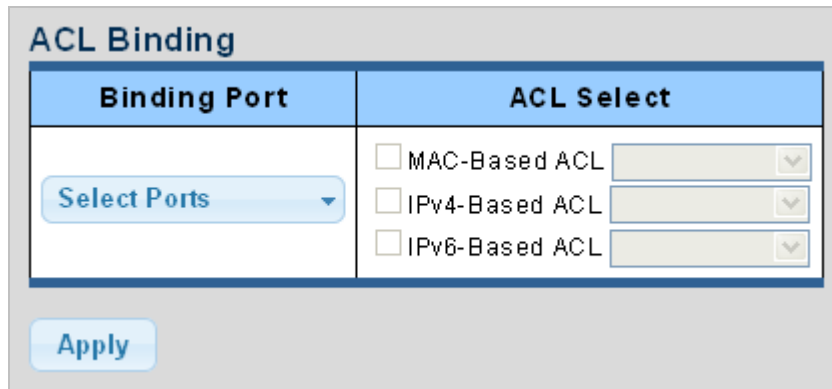



Figure 4-10-13 ACL Binding Page Screenshot

The page includes the following fields:

| Object | Description |
|-----------------------|--|
| • Binding Port | Select port from this drop-down list |
| • ACL Select | Select ACL list from this drop-down list |

Buttons

: Click to apply changes.

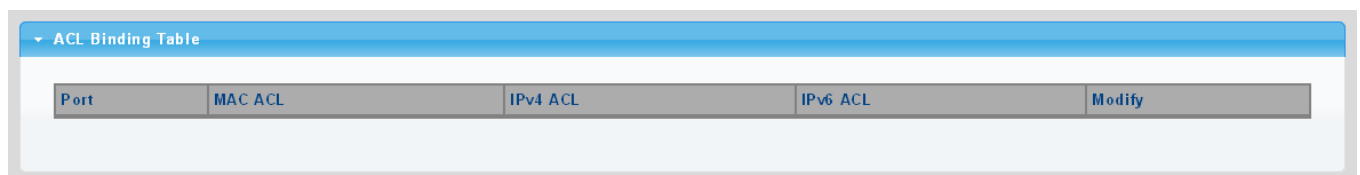



Figure 4-10-14 ACL Binding Table Page Screenshot

The page includes the following fields:

| Object | Description |
|-------------------|---|
| • Port | The switch port number of the logical port |
| • MAC ACL | Display the current MAC ACL |
| • IPv4 ACL | Display the current IPv4 ACL |
| • IPv6 ACL | Display the current IPv6 ACL |
| • Modify | <p>Click  to edit ACL binding table parameter</p> <p>Click  to delete ACL binding entry</p> |

4.11 MAC Address Table

Switching of frames is based upon the DMAC address contained in the frame. The LRP Managed Switch builds up a table that maps MAC addresses to switch ports for knowing which ports the frames should go to (based upon the DMAC address in the frame). This table contains both static and dynamic entries. The static entries are configured by the network administrator if the administrator wants to do a fixed mapping between the DMAC address and switch ports.

The frames also contain a MAC address (SMAC address), which shows the MAC address of the equipment sending the frame. The SMAC address is used by the switch to automatically update the MAC table with these dynamic MAC addresses. Dynamic entries are removed from the MAC table if no frame with the corresponding SMAC address has been seen after a configurable age time.

4.11.1 Static MAC Setting

The static entries in the MAC table are shown in this table. The MAC table is sorted first by VLAN ID and then by MAC address. The Static MAC Setting screens in [Figure 4-11-1](#) & [Figure 4-11-2](#) appear.

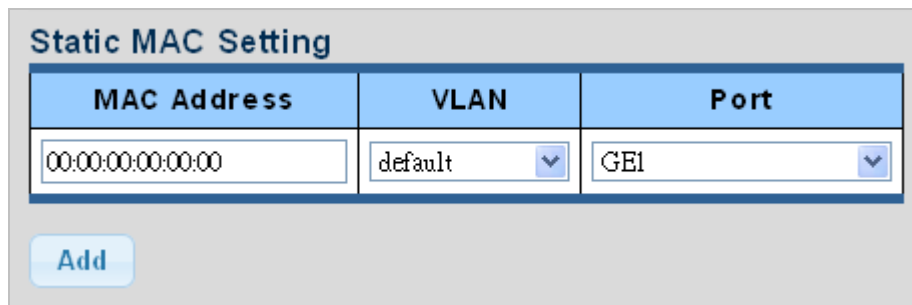

| MAC Address | VLAN | Port |
|-------------------|---------|------|
| 00:00:00:00:00:00 | default | GE1 |

Add

Figure 4-11-1 Statics MAC Setting Page Screenshot

The page includes the following fields:

| Object | Description |
|----------------------|---|
| • MAC Address | Physical address associated with this interface |
| • VLAN | Select VLAN from this drop-down list |
| • Port | Select port from this drop-down list |

Buttons

Add: Click to add new static MAC address.

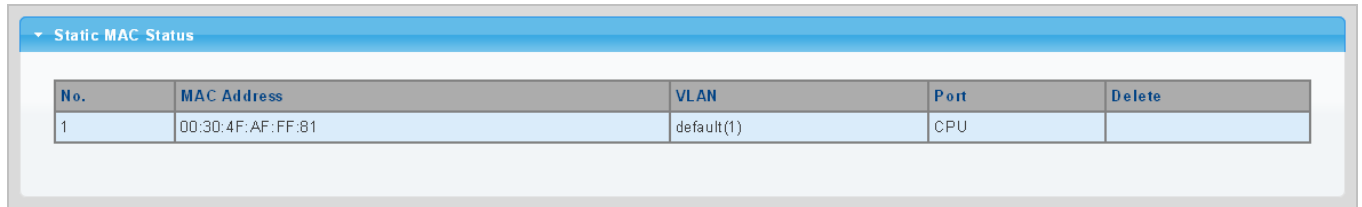

Figure 4-11-2 Statics MAC Status Page Screenshot

The page includes the following fields:

| Object | Description |
|----------------------|---|
| • No. | This is the number for entries |
| • MAC Address | The MAC address for the entry |
| • VLAN | The VLAN ID for the entry |
| • Port | Display the current port |
| • Delete | Click Delete to delete static MAC status entry |

4.11.2 MAC Filtering

By filtering MAC address, the switch can easily filter the pre-configured MAC address and reduce the un-safety. The Static MAC Setting screens in [Figure 4-11-3](#) & [Figure 4-11-4](#) appear.

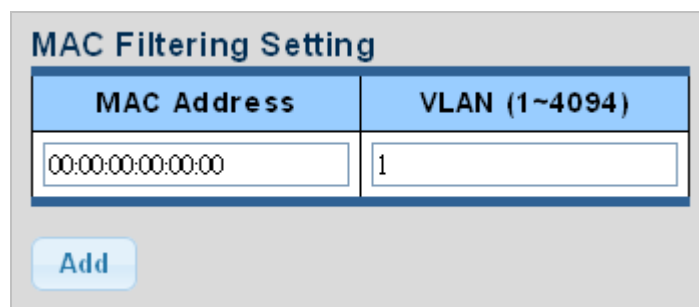

Figure 4-11-3 MAC Filtering Setting Page Screenshot

The page includes the following fields:

| Object | Description |
|------------------------|---|
| • MAC Address | Physical address associated with this interface |
| • VLAN (1~4096) | Indicates the ID of this particular VLAN |

Buttons

Add: Click to add new MAC filtering setting.

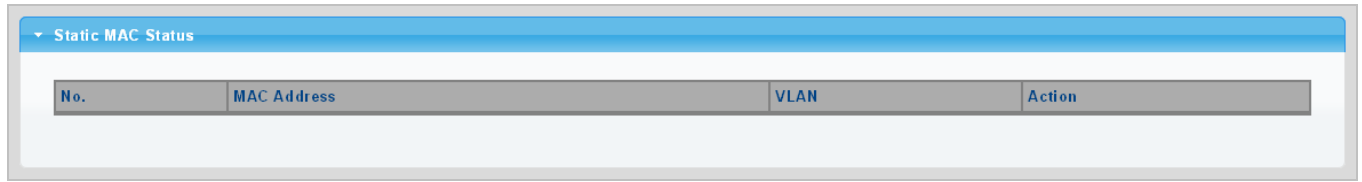

Figure 4-11-4 Statics MAC Status Page Screenshot

The page includes the following fields:

| Object | Description |
|----------------------|--|
| • No. | This is the number for entries |
| • MAC Address | The MAC address for the entry |
| • VLAN | The VLAN ID for the entry |
| • Delete | Click Delete to delete static MAC status entry. |

4.11.3 Dynamic Address Setting

By default, dynamic entries are removed from the MAC table after 300 seconds. The Dynamic Address Setting/Status screens in [Figure 4-11-5](#) & [Figure 4-11-6](#) appear.

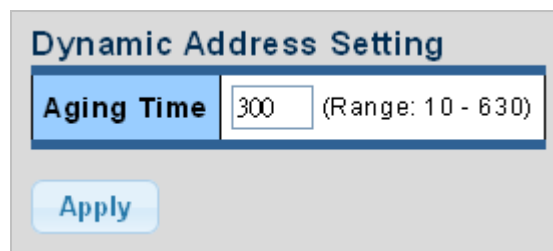

Figure 4-11-5 Dynamic Addresses Setting Page Screenshot

The page includes the following fields:

| Object | Description |
|---------------------|--|
| • Aging Time | The time after which a learned entry is discarded (Range: 10-630 seconds; Default: 300 seconds) |

Buttons

: Click to apply changes.

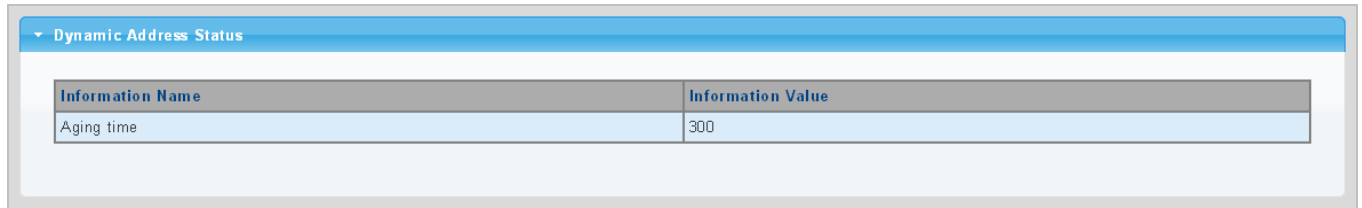

Figure 4-11-6 Dynamic Addresses Status Page Screenshot

The page includes the following fields:

| Object | Description |
|---------------------|--------------------------------|
| • Aging Time | Display the current aging time |

4.11.4 Dynamic Learned

Dynamic MAC Table

The Dynamically Learned MAC Table is shown on this page. The MAC Table is sorted first by VLAN ID and then by MAC address. The Dynamically Learned screens in [Figure 4-11-6](#) & [Figure 4-11-7](#) appear.

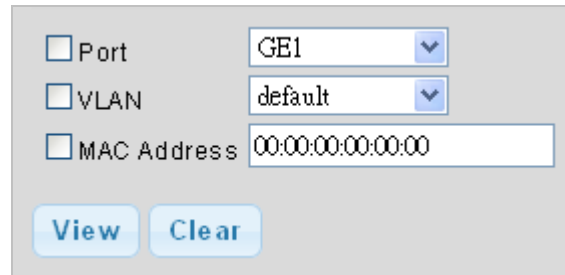

Figure 4-11-6 Dynamically Learned Page Screenshot

The page includes the following fields:

| Object | Description |
|----------------------|---|
| • Port | Select port from this drop-down list |
| • VLAN | Select VLAN from this drop-down list |
| • MAC Address | Physical address associated with this interface |

Buttons

View : Refreshes the displayed table starting from the "Start from MAC address" and "VLAN" input fields

Clear : Flushes all dynamic entries

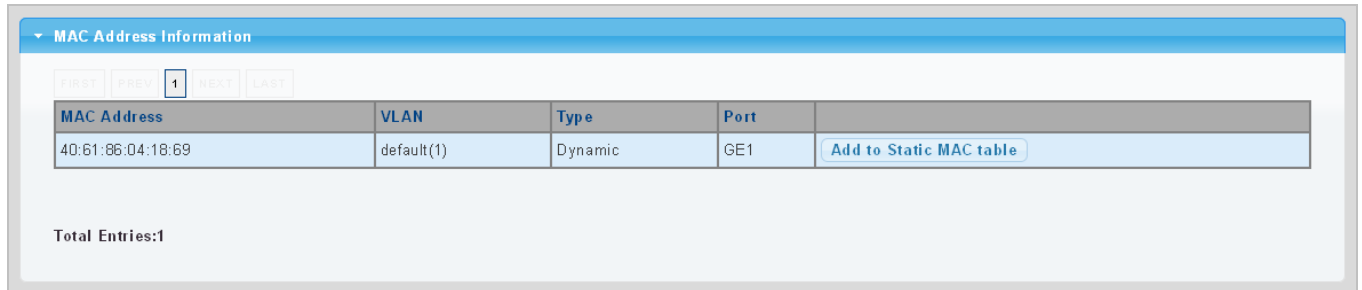

Figure 4-11-7 MAC Address Information Page Screenshot

| Object | Description |
|----------------------|--|
| • MAC Address | The MAC address of the entry |
| • VLAN | The VLAN ID of the entry |
| • Type | Indicates whether the entry is a static or dynamic entry |
| • Port | The ports that are members of the entry |

Buttons

Add to Static MAC table : Click to add dynamic MAC address to static MAC address.

4.12 LLDP

4.12.1 Link Layer Discovery Protocol

Link Layer Discovery Protocol (LLDP) is used to discover basic information about neighboring devices on the local broadcast domain. LLDP is a Layer 2 protocol that uses periodic broadcasts to advertise information about the sending device. Advertised information is represented in **Type Length Value (TLV)** format according to the IEEE 802.1ab standard, and can include details such as device identification, capabilities and configuration settings. LLDP also defines how to store and maintain information gathered about the neighboring network nodes it discovers.

Link Layer Discovery Protocol - Media Endpoint Discovery (LLDP-MED) is an extension of LLDP intended for managing endpoint devices such as Voice over IP phones and network switches. The LLDP-MED TLVs advertise information such as network policy, power, inventory, and device location details. LLDP and LLDP-MED information can be used by SNMP applications to simplify troubleshooting, enhance network management, and maintain an accurate network topology.

4.12.2 LLDP Global Setting

This page allows the user to inspect and configure the current LLDP port settings. The LLDP Global Setting and Config screens in [Figure 4-12-1](#) & [Figure 4-12-2](#) appear.

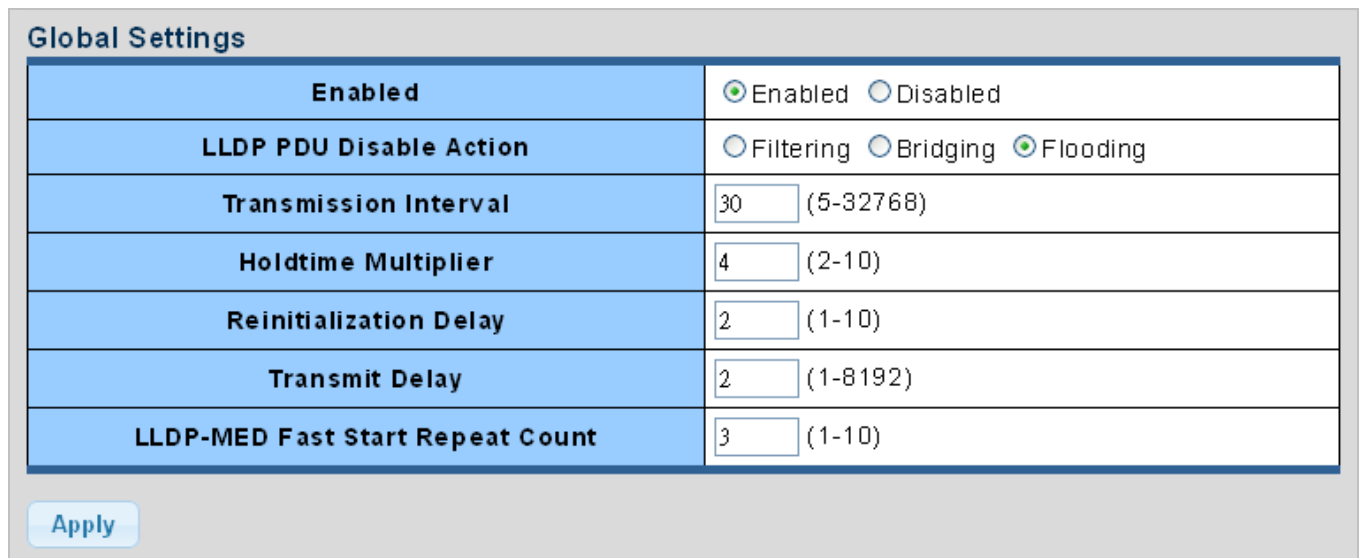

| Global Settings | |
|---|--|
| Enabled | <input checked="" type="radio"/> Enabled <input type="radio"/> Disabled |
| LLDP PDU Disable Action | <input type="radio"/> Filtering <input type="radio"/> Bridging <input checked="" type="radio"/> Flooding |
| Transmission Interval | 30 (5-32768) |
| Holdtime Multiplier | 4 (2-10) |
| Reinitialization Delay | 2 (1-10) |
| Transmit Delay | 2 (1-8192) |
| LLDP-MED Fast Start Repeat Count | 3 (1-10) |

Apply

Figure 4-12-1 Global Setting Page Screenshot

The page includes the following fields:

| Object | Description |
|----------------------------------|--|
| • Enable | Globally enable or disable LLDP function |
| • LLDP PDU Disable Action | Set LLDP PDU disable action: include "Filtering", "Bridging" and "Flooding". <ul style="list-style-type: none"> ■ Filtering: discard all LLDP PDUs. |

| | |
|---|---|
| | <ul style="list-style-type: none"> ■ Bridging: transmit LLDP PDU in the same VLAN. ■ Flooding: transmit LLDP PDU for all port. |
| <ul style="list-style-type: none"> • Transmission Interval | <p>The switch is periodically transmitting LLDP frames to its neighbors for having the network discovery information up-to-date. The interval between each LLDP frame is determined by the Transmission Interval value. Valid values are restricted to 5 - 32768 seconds.</p> <p>Default: 30 seconds</p> <p>This attribute must comply with the following rule:</p> <p>$(\text{Transmission Interval} * \text{Hold Time Multiplier}) \leq 65536$, and $\text{Transmission Interval} \geq (4 * \text{Delay Interval})$</p> |
| <ul style="list-style-type: none"> • Holdtime Multiplier | <p>Each LLDP frame contains information about how long the information in the LLDP frame shall be considered valid. The LLDP information valid period is set to Holdtime multiplied by Transmission Interval seconds. Valid values are restricted to 2 - 10 times.</p> <p>TTL in seconds is based on the following rule:</p> <p>$(\text{Transmission Interval} * \text{Holdtime Multiplier}) \leq 65536$.</p> <p>Therefore, the default TTL is $4 * 30 = 120$ seconds.</p> |
| <ul style="list-style-type: none"> • Reinitialization Delay | <p>When a port is disabled, LLDP is disabled or the switch is rebooted a LLDP shutdown frame is transmitted to the neighboring units, signaling that the LLDP information isn't valid anymore. TX Reinit controls the amount of seconds between the shutdown frame and a new LLDP initialization. Valid values are restricted to 1 - 10 seconds.</p> |
| <ul style="list-style-type: none"> • Transmit Delay | <p>If some configuration is changed (e.g. the IP address) a new LLDP frame is transmitted, but the time between the LLDP frames will always be at least the value of Transmit Delay seconds. Transmit Delay cannot be larger than 1/4 of the Transmission Interval value. Valid values are restricted to 1 - 8192 seconds.</p> <p>This attribute must comply with the rule:</p> <p>$(4 * \text{Delay Interval}) \leq \text{Transmission Interval}$</p> |
| <ul style="list-style-type: none"> • LLDP-MED Fast Start Repeat Count | <p>Configures the amount of LLDP MED Fast Start LLDPDUs to transmit during the activation process of the LLDP-MED Fast Start mechanism.</p> <p>Range: 1-10 packets;</p> <p>Default: 3 packets</p> <p>The MED Fast Start Count parameter is part of the timer which ensures that the LLDP-MED Fast Start mechanism is active for the port. LLDP-MED Fast Start is critical to the timely startup of LLDP, and therefore integral to the rapid availability of Emergency Call Service.</p> |

Buttons

: Click to apply changes.

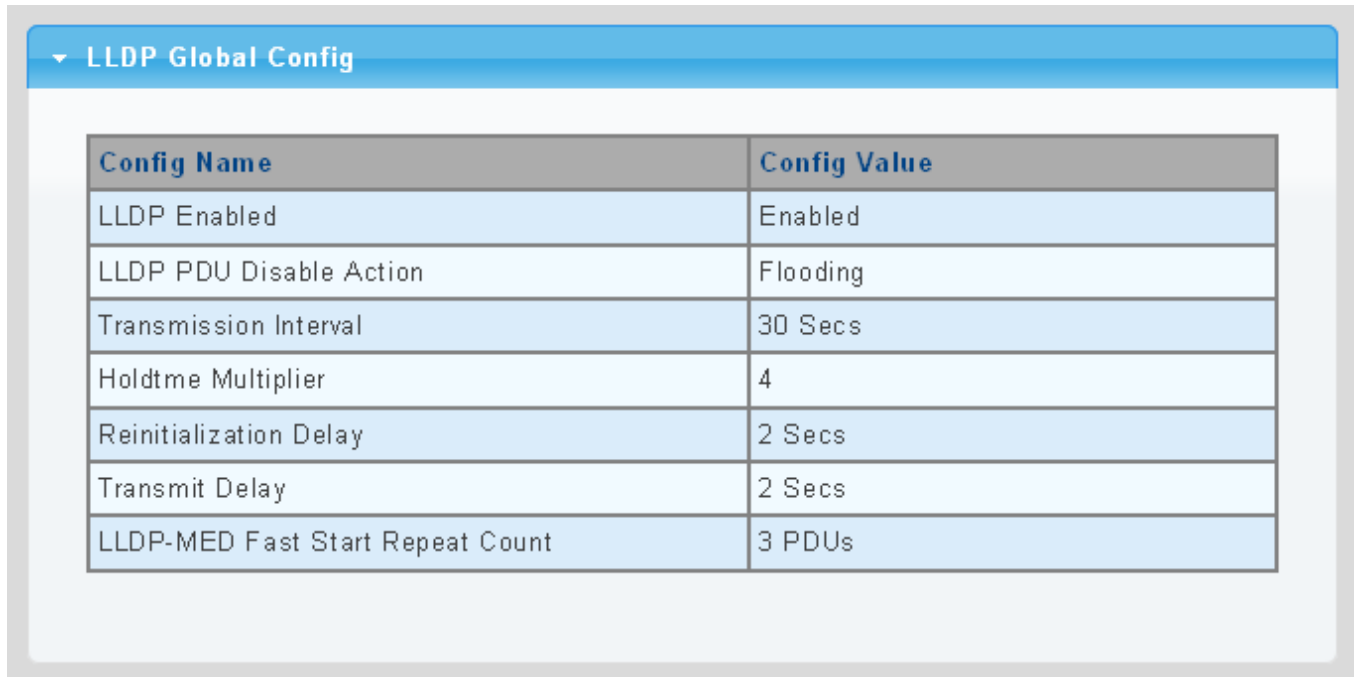

Figure 4-12-2 LLDP Global Config Page Screenshot

The page includes the following fields:

| Object | Description |
|---|--|
| • LLDP Enable | Display the current LLDP status |
| • LLDP PDU Disable Action | Display the current LLDP PDU disable action |
| • Transmission Interval | Display the current transmission interval |
| • Holdtime Multiplier | Display the current holdtime multiplier |
| • Reinitialization Delay | Display the current reinitialization delay |
| • Transmit Delay | Display the current transmit delay |
| • LLDP-MED Fast Start Repeat Count | Display the current LLDP-MED Fast Start Repeat Count |

4.12.3 LLDP Port Setting

Use the LLDP Port Setting to specify the message attributes for individual interfaces, including whether messages are transmitted, received, or both transmitted and received. The LLDP Port Configuration and Status screens in [Figure 4-12-3](#) & [Figure 4-12-4](#) appear.

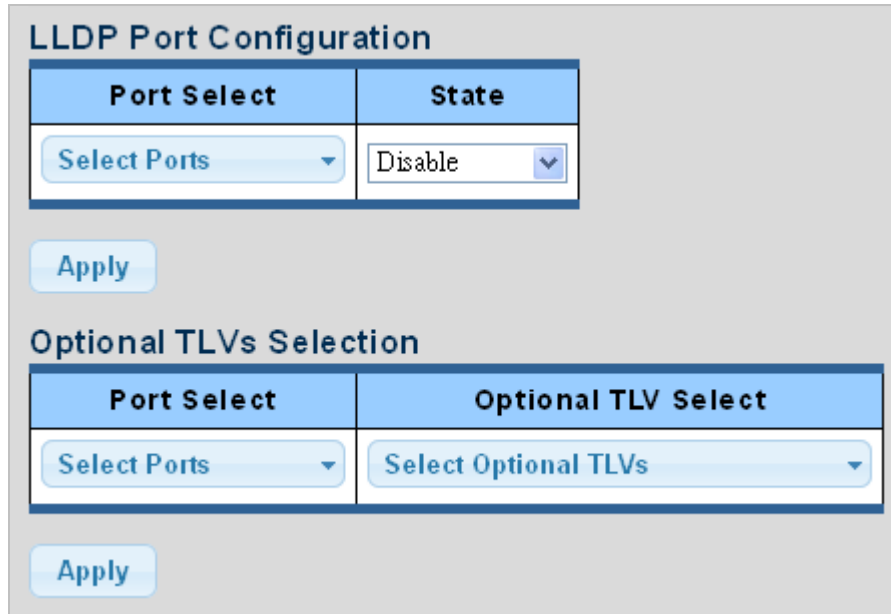

Figure 4-12-3 LLDP Port Configuration and Optional TLVs Selection Page Screenshot

The page includes the following fields:

| Object | Description |
|--|---|
| <ul style="list-style-type: none"> • Port Select | Select port from this drop-down list |
| <ul style="list-style-type: none"> • State | Enables LLDP messages transmit and receive modes for LLDP Protocol Data Units. Options: <ul style="list-style-type: none"> ■ TX only ■ RX only ■ Tx RX ■ Disabled |
| <ul style="list-style-type: none"> • Port Select | Select port from this drop-down list |
| <ul style="list-style-type: none"> • Optional TLV Select | Configures the information included in the TLV field of advertised messages. <ul style="list-style-type: none"> ■ System Name: When checked the "System Name" is included in LLDP information transmitted. ■ Port Description: When checked the "Port Description" is included in LLDP information transmitted. ■ System Description: When checked the "System Description" is included in LLDP information transmitted. ■ System Capability: When checked the "System Capability" is included in LLDP information transmitted. |

| | |
|--|---|
| | <ul style="list-style-type: none"> ■ 802.3 MAC-PHY: When checked the "802.3 MAC-PHY" is included in LLDP information transmitted. ■ 802.3 Link Aggregation: When checked the "802.3 Link Aggregation" is included in LLDP information transmitted. ■ 802.3 Maximum Frame Size: When checked the "802.3 Maximum Frame Size" is included in LLDP information transmitted. ■ Management Address: When checked the "Management Address" is included in LLDP information transmitted. ■ 802.1 PVID: When checked the "802.1 PVID" is included in LLDP information transmitted. |
|--|---|

Buttons



: Click to apply changes

▼ LLDP Port Status

| Port | State | Selected Optional TLVs |
|------|-------|------------------------|
| GE1 | TX&RX | 802.1 PVID |
| GE2 | TX&RX | 802.1 PVID |
| GE3 | TX&RX | 802.1 PVID |
| GE4 | TX&RX | 802.1 PVID |
| GE5 | TX&RX | 802.1 PVID |
| GE6 | TX&RX | 802.1 PVID |
| GE7 | TX&RX | 802.1 PVID |
| GE8 | TX&RX | 802.1 PVID |
| GE9 | TX&RX | 802.1 PVID |
| GE10 | TX&RX | 802.1 PVID |

Figure 4-12-4 LLDP Port Status Page Screenshot

The page includes the following fields:

| Object | Description |
|---------------------------------|--|
| • Port | The switch port number of the logical port |
| • State | Display the current LLDP status |
| • Selected Optional TLVs | Display the current selected optional TLVs |

The VLAN Name TLV VLAN Selection and LLDP Port VLAN TLV Status screens in [Figure 4-12-5](#) & [Figure 4-12-6](#) appear.

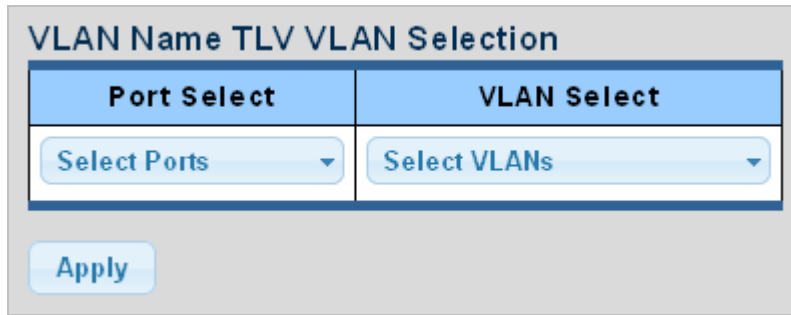



Figure 4-12-5 VLAN Name TLV Selection Page Screenshot

The page includes the following fields:

| Object | Description |
|--|---------------------------------------|
| <ul style="list-style-type: none"> • Port Select | Select port from this drop-down list. |
| <ul style="list-style-type: none"> • VLAN Select | Select VLAN from this drop-down list. |

Buttons

: Click to apply changes.

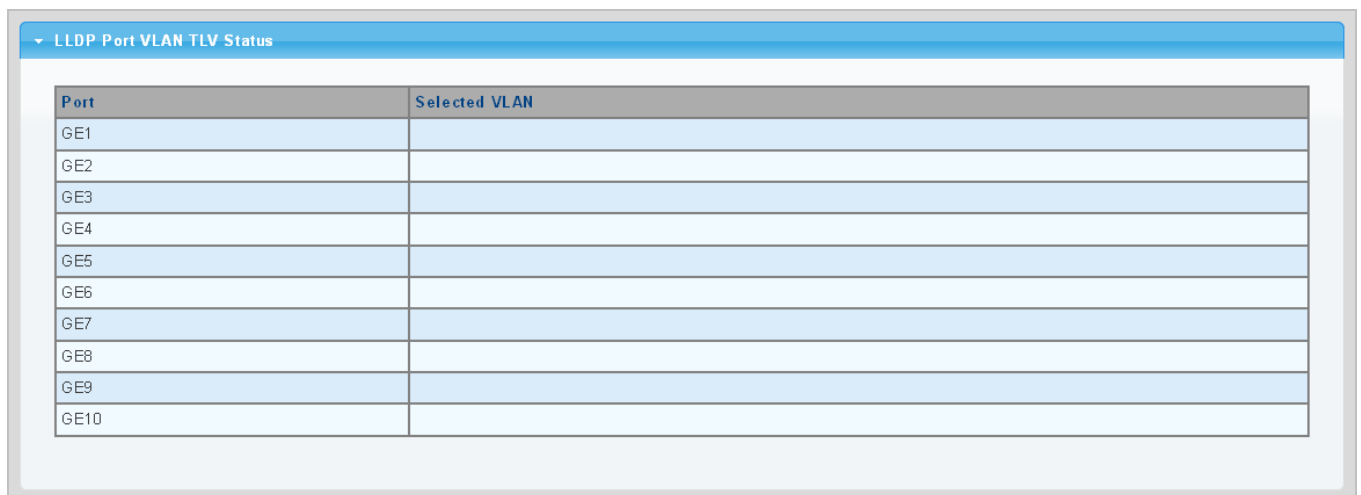

Figure 4-12-6 LLDP Port VLAN TLV Status Page Screenshot

The page includes the following fields:

| Object | Description |
|--|--|
| <ul style="list-style-type: none"> • Port | The switch port number of the logical port |
| <ul style="list-style-type: none"> • Selected VLAN | Display the current selected VLAN |

4.12.4 LLDP Local Device

Use the LLDP Local Device Information screen to display information about the switch, such as its **MAC address**, **chassis ID**, **management IP address**, and **port information**. The Local Device Summary and Port Status screens in [Figure 4-12-7](#) & [Figure 4-12-8](#) appear.

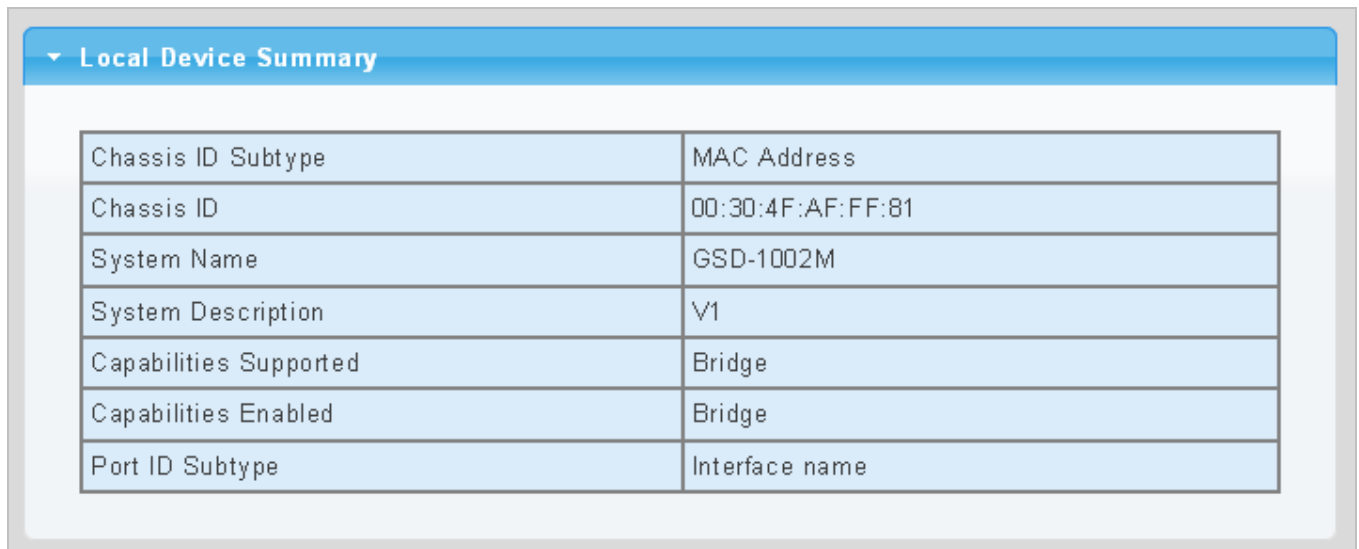

| Local Device Summary | |
|------------------------|-------------------|
| Chassis ID Subtype | MAC Address |
| Chassis ID | 00:30:4F:AF:FF:81 |
| System Name | GSD-1002M |
| System Description | V1 |
| Capabilities Supported | Bridge |
| Capabilities Enabled | Bridge |
| Port ID Subtype | Interface name |

Figure 4-12-7 Local Device Summary Page Screenshot

The page includes the following fields:

| Object | Description |
|---------------------------------|--|
| • Chassis ID Subtype | Display the current chassis ID subtype |
| • Chassis ID | Display the current chassis ID |
| • System Name | Display the current system name |
| • System Description | Display the current system description |
| • Capabilities Supported | Display the current capabilities supported |
| • Capabilities Enabled | Display the current capabilities enabled |
| • Port ID Subtype | Display the current port ID subtype |

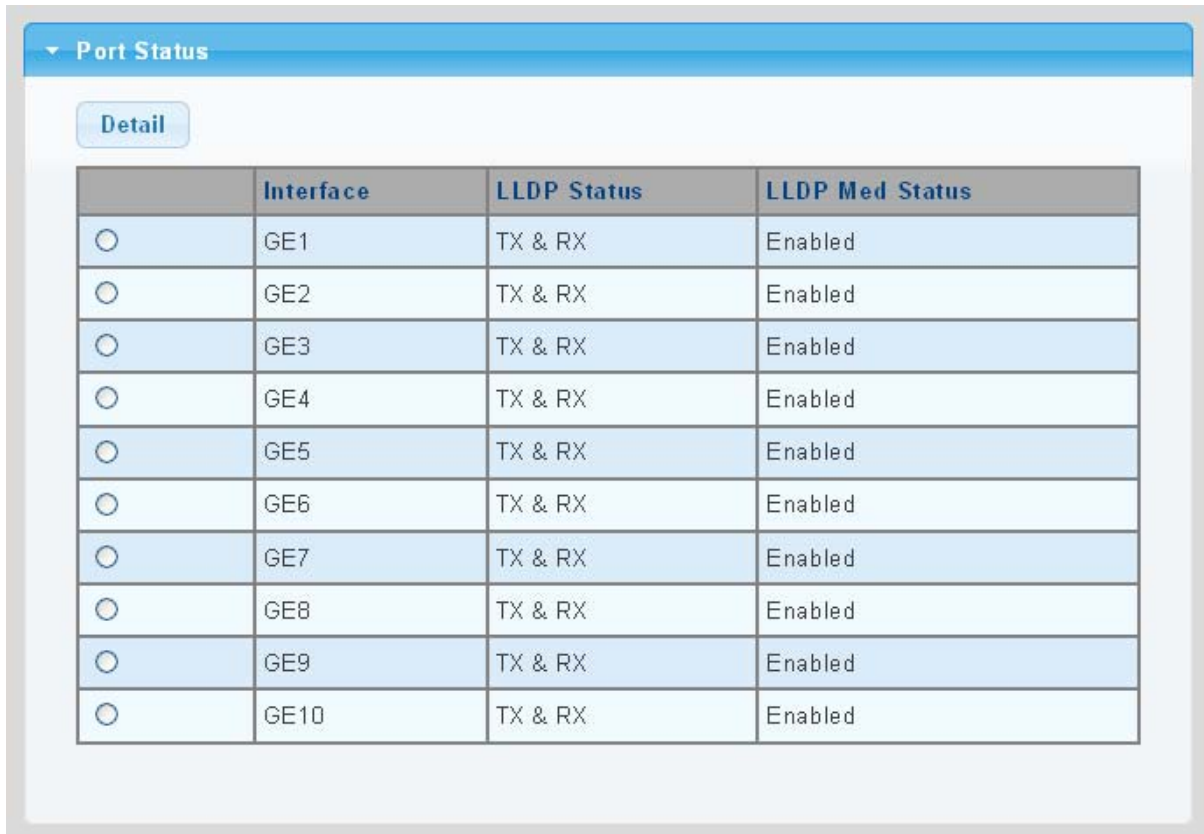

| | Interface | LLDP Status | LLDP Med Status |
|-----------------------|-----------|-------------|-----------------|
| <input type="radio"/> | GE1 | TX & RX | Enabled |
| <input type="radio"/> | GE2 | TX & RX | Enabled |
| <input type="radio"/> | GE3 | TX & RX | Enabled |
| <input type="radio"/> | GE4 | TX & RX | Enabled |
| <input type="radio"/> | GE5 | TX & RX | Enabled |
| <input type="radio"/> | GE6 | TX & RX | Enabled |
| <input type="radio"/> | GE7 | TX & RX | Enabled |
| <input type="radio"/> | GE8 | TX & RX | Enabled |
| <input type="radio"/> | GE9 | TX & RX | Enabled |
| <input type="radio"/> | GE10 | TX & RX | Enabled |

Figure 4-12-8 Port Status Page Screenshot

The page includes the following fields:

| Object | Description |
|--------------------------|---|
| • Interface | The switch port number of the logical port. |
| • LLDP Status | Display the current LLDP status |
| • LLDP MED Status | Display the current LLDP MED Status |

4.12.5 LLDP Remote Device

This page provides a status overview for all LLDP remote devices. The displayed table contains a row for each port on which an LLDP neighbor is detected. The LLDP Remote Device screen in [Figure 4-12-9](#) appears.

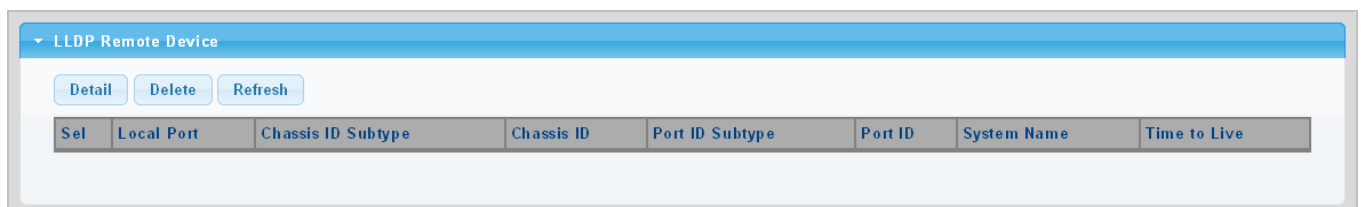

| Sel | Local Port | Chassis ID Subtype | Chassis ID | Port ID Subtype | Port ID | System Name | Time to Live |
|-----|------------|--------------------|------------|-----------------|---------|-------------|--------------|
|-----|------------|--------------------|------------|-----------------|---------|-------------|--------------|

Figure 4-12-9 LLDP Remote Device Page Screenshot

The page includes the following fields:

| Object | Description |
|-----------------------------|--|
| • Local Port | Display the current local port |
| • Chassis ID Subtype | Display the current chassis ID subtype |
| • Chassis ID | The Chassis ID is the identification of the neighbor's LLDP frames |
| • Port ID Subtype | Display the current port ID subtype |
| • Port ID | The Remote Port ID is the identification of the neighbor port |
| • System Name | System Name is the name advertised by the neighbor unit |
| • Time to Live | Display the current time to live |

Buttons

Delete : Click to delete LLDP remote device entry.

Refresh : Click to refresh LLDP remote device.

4.12.6 MED Network Policy

Network Policy Discovery enables the efficient discovery and diagnosis of mismatch issues with the VLAN configuration, along with the associated Layer 2 and Layer 3 attributes, which apply for a set of specific protocol applications on that port. Improper network policy configurations are a very significant issue in VoIP environments that frequently result in voice quality degradation or loss of service.

Policies are only intended for use with applications that have specific 'real-time' network policy requirements, such as interactive voice and/or video services.

The network policy attributes advertised are:

1. Layer 2 VLAN ID (IEEE 802.1Q-2003)
2. Layer 2 priority value (IEEE 802.1D-2004)
3. Layer 3 Diffserv code point (DSCP) value (IETF RFC 2474)

This network policy is potentially advertised and associated with multiple sets of application types supported on a given port.

The application types specifically addressed are:

1. Voice
2. Guest Voice
3. Softphone Voice
4. Video Conferencing
5. Streaming Video
6. Control / Signaling (conditionally support a separate network policy for the media types above)

A large network may support multiple VoIP policies across the entire organization, and different policies per application type.

LLDP-MED allows multiple policies to be advertised per port, each corresponding to a different application type. Different ports on the same Network Connectivity Device may advertise different sets of policies, based on the authenticated user identity or port configuration.

It should be noted that LLDP-MED is not intended to run on links other than between Network Connectivity Devices and Endpoints, and therefore does not need to advertise the multitude of network policies that frequently run on an aggregated link interior to the LAN.

The Voice Auto Mode Configuration, Network Policy Configuration and LLDP MED Network Policy Table screens in [Figure 4-12-10](#) & [Figure 4-12-11](#) appear.

Voice Auto Mode Configuration

LLDP MED Policy for Voice Application

 Auto Manual

Apply

Network Policy Configuration

| | |
|-----------------------|--|
| Network Policy Number | 1 <input type="button" value="v"/> |
| Application | Voice <input type="button" value="v"/> |
| VLAN ID | 1 (1-4094) |
| VLAN Tag | <input checked="" type="radio"/> Tagged <input type="radio"/> Untagged |
| L2 Priority | 0 (0-7) |
| DSCP Value | 0 (0-63) |

Apply

Figure 4-12-10 Voice Auto Mode Configuration and Network Policy Configuration Page Screenshot

The page includes the following fields:

| Object | Description |
|--|---|
| <ul style="list-style-type: none"> • LLDP MED Policy for Voice Application | Set the LLDP MED policy for voice application mode |
| <ul style="list-style-type: none"> • Network Policy Number | Select network policy number for this drop down list |
| <ul style="list-style-type: none"> • Application Type | <p>Intended use of the application types:</p> <p>Voice - for use by dedicated IP Telephony handsets and other similar appliances supporting interactive voice services. These devices are typically deployed on a separate VLAN for ease of deployment and enhanced security by isolation from data applications.</p> <p>Voice Signaling - for use in network topologies that require a different policy for the voice signaling than for the voice media. This application type should not be advertised if all the same network policies apply as those advertised in the Voice application policy.</p> <p>Guest Voice - support a separate 'limited feature-set' voice service for guest users and visitors with their own IP Telephony handsets and other similar appliances supporting interactive voice services.</p> <p>Guest Voice Signaling - for use in network topologies that require a different policy for the guest voice signaling than for the guest voice media. This application type should not be advertised if all the same network policies apply as those advertised in the Guest Voice application policy.</p> |

| | |
|--|--|
| | <p>Softphone Voice - for use by softphone applications on typical data centric devices, such as PCs or laptops. This class of endpoints frequently does not support multiple VLANs, if at all, and are typically configured to use an 'untagged' VLAN or a single 'tagged' data specific VLAN. When a network policy is defined for use with an 'untagged' VLAN (see Tagged flag below), then the L2 priority field is ignored and only the DSCP value has relevance.</p> <p>Video Conferencing - for use by dedicated Video Conferencing equipment and other similar appliances supporting real-time interactive video/audio services.</p> <p>App Streaming Video - for use by broadcast or multicast based video content distribution and other similar applications supporting streaming video services that require specific network policy treatment. Video applications relying on TCP with buffering would not be an intended use of this application type.</p> <p>Video Signaling - for use in network topologies that require a separate policy for the video signaling than for the video media. This application type should not be advertised if all the same network policies apply as those advertised in the Video Conferencing application policy.</p> |
| <ul style="list-style-type: none"> • VLAN ID | <p>VLAN identifier (VID) for the port as defined in IEEE 802.1Q-2003</p> |
| <ul style="list-style-type: none"> • Tag | <p>Tag indicating whether the specified application type is using a 'tagged' or an 'untagged' VLAN.</p> <p>Untagged indicates that the device is using an untagged frame format and as such does not include a tag header as defined by IEEE 802.1Q-2003. In this case, both the VLAN ID and the Layer 2 priority fields are ignored and only the DSCP value has relevance.</p> <p>Tagged indicates that the device is using the IEEE 802.1Q tagged frame format, and that both the VLAN ID and the Layer 2 priority values are being used, as well as the DSCP value. The tagged format includes an additional field, known as the tag header. The tagged frame format also includes priority tagged frames as defined by IEEE 802.1Q-2003.</p> |
| <ul style="list-style-type: none"> • L2 Priority | <p>L2 Priority is the Layer 2 priority to be used for the specified application type. L2 Priority may specify one of eight priority levels (0 through 7), as defined by IEEE 802.1D-2004. A value of 0 represents use of the default priority as defined in IEEE 802.1D-2004.</p> |
| <ul style="list-style-type: none"> • DSCP | <p>DSCP value to be used to provide Diffserv node behavior for the specified application type as defined in IETF RFC 2474. DSCP may contain one of 64 code point values (0 through 63). A value of 0 represents use of the default DSCP value as defined in RFC 2475.</p> |

Buttons

Apply: Click to apply changes.

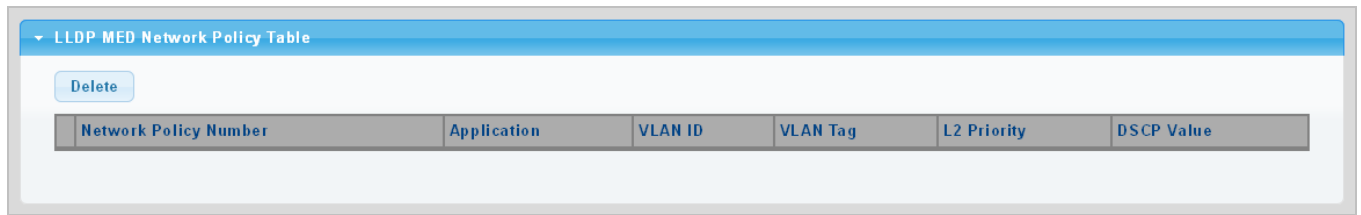

Figure 4-12-11 LLDP MED Network Policy Table Page Screenshot

The page includes the following fields:

| Object | Description |
|--------------------------------|---|
| • Network Policy Number | Display the current network policy number |
| • Application | Display the current application |
| • VLAN ID | Display the current VLAN ID |
| • VLAN Tag | Display the current VLAN tag status |
| • L2 Priority | Display the current L2 priority |
| • DSCP Value | Display the current DSCP value |

Buttons

Delete: Click to delete LLDP MED network policy table entry.

4.12.7 MED Port Setting

The Port LLDP MED Configuration/Port Setting Table screens in [Figure 4-12-12](#) & [Figure 4-12-13](#) appear.

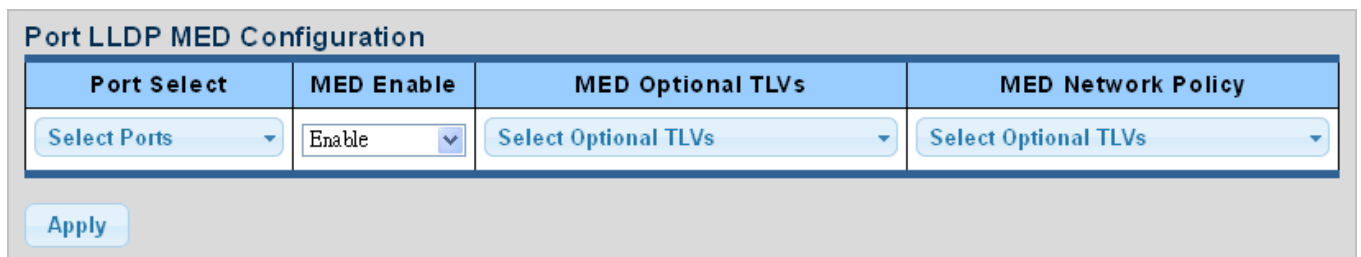

Figure 4-12-12 Port LLDP MED Configuration Page Screenshot

The page includes the following fields:

| Object | Description |
|---|---|
| <ul style="list-style-type: none"> • Port Select | Select port from this drop-down list |
| <ul style="list-style-type: none"> • MED Enable | Enable or disable MED configuration |
| <ul style="list-style-type: none"> • MED Optional TVLs | <p>Configures the information included in the MED TLV field of advertised messages.</p> <p>-Network Policy – This option advertises network policy configuration information, aiding in the discovery and diagnosis of VLAN configuration mismatches on a port. Improper network policy configurations frequently result in voice quality degradation or complete service disruption.</p> <p>-Location – This option advertises location identification details.</p> <p>-Inventory – This option advertises device details useful for inventory management, such as manufacturer, model, software version and other pertinent information.</p> |
| <ul style="list-style-type: none"> • MED Network Policy | Select MED network policy from this drop-down list |

Buttons

: Click to apply changes.

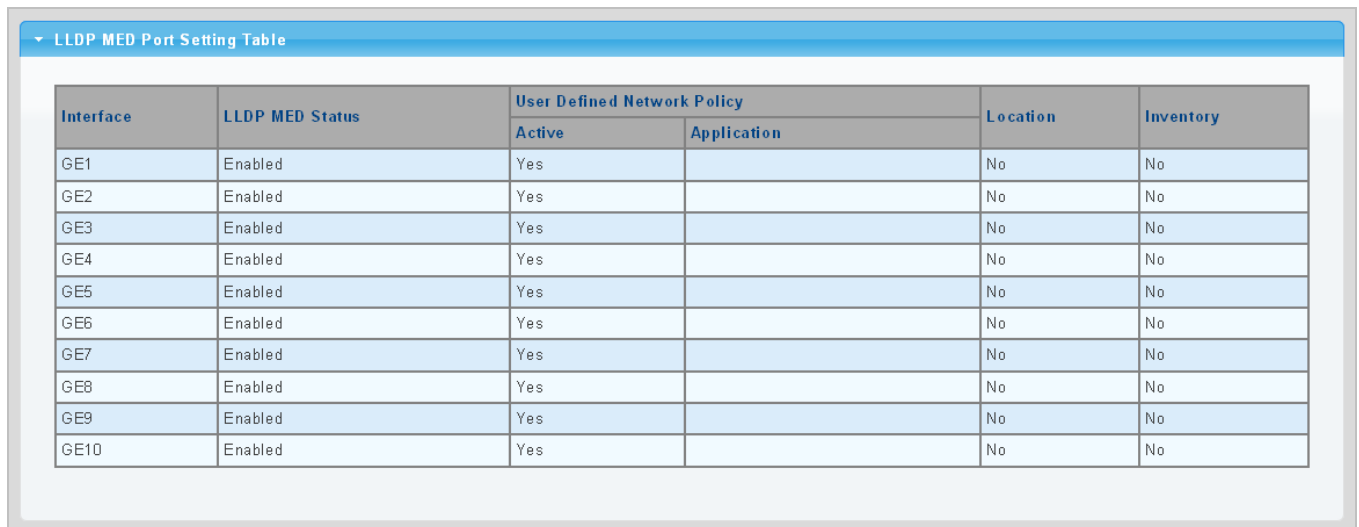

The screenshot shows a table titled "LLDP MED Port Setting Table" with the following data:

| Interface | LLDP MED Status | User Defined Network Policy | | Location | Inventory |
|-----------|-----------------|-----------------------------|-------------|----------|-----------|
| | | Active | Application | | |
| GE1 | Enabled | Yes | | No | No |
| GE2 | Enabled | Yes | | No | No |
| GE3 | Enabled | Yes | | No | No |
| GE4 | Enabled | Yes | | No | No |
| GE5 | Enabled | Yes | | No | No |
| GE6 | Enabled | Yes | | No | No |
| GE7 | Enabled | Yes | | No | No |
| GE8 | Enabled | Yes | | No | No |
| GE9 | Enabled | Yes | | No | No |
| GE10 | Enabled | Yes | | No | No |

Figure 4-12-13 Port LLDP MED Configuration Page Screenshot

The page includes the following fields:

| Object | Description |
|--|--|
| <ul style="list-style-type: none"> • Interface | The switch port number of the logical port |
| <ul style="list-style-type: none"> • LLDP MED Status | Display the current LLDP MED status |
| <ul style="list-style-type: none"> • Active | Display the current active status |

| | |
|----------------------|---------------------------------|
| • Application | Display the current application |
| • Location | Display the current location |
| • Inventory | Display the current inventory |

The MED Location Configuration and LLDP MED Port Location Table screens in [Figure 4-12-14](#) & [Figure 4-12-15](#) appear.

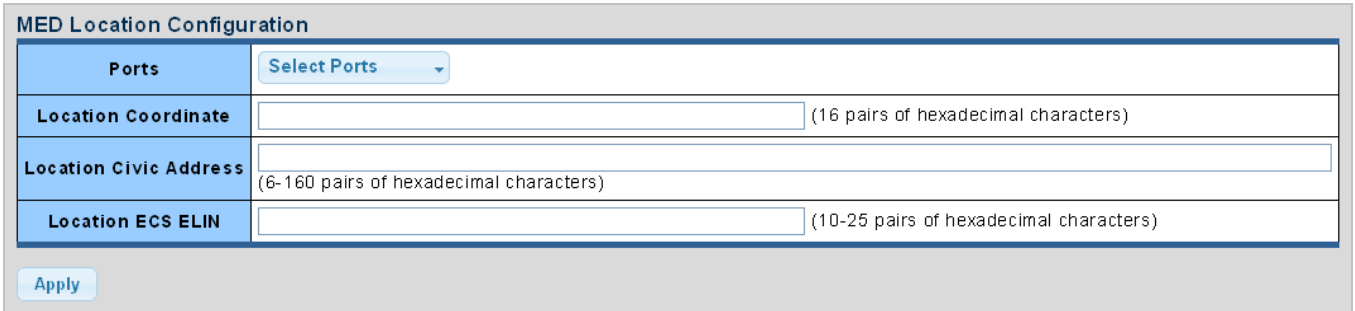



Figure 4-12-14 Port LLDP MED Configuration Page Screenshot

The page includes the following fields:

| Object | Description |
|---------------------------------|--|
| • Port | Select port from this drop-down list |
| • Location Coordinate | A string identifying the Location Coordinate that this entry should belong to |
| • Location Civic Address | A string identifying the Location Civic Address that this entry should belong to |
| • Location ESC ELIN | A string identifying the Location ESC ELIN that this entry should belong to |

Buttons

: Click to apply changes.

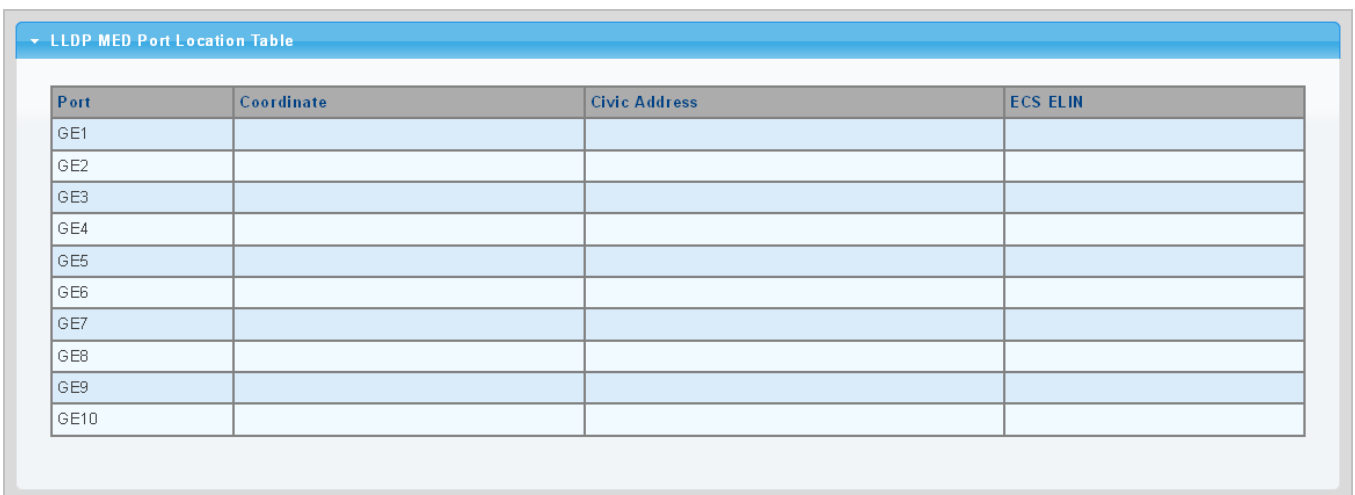

| Port | Coordinate | Civic Address | ECS ELIN |
|------|------------|---------------|----------|
| GE1 | | | |
| GE2 | | | |
| GE3 | | | |
| GE4 | | | |
| GE5 | | | |
| GE6 | | | |
| GE7 | | | |
| GE8 | | | |
| GE9 | | | |
| GE10 | | | |

Figure 4-12-15 LLDP MED Port Location Table Page Screenshot

The page includes the following fields:

| Object | Description |
|-----------------|--|
| • Port | The switch port number of the logical port |
| • Coordinate | Display the current coordinate |
| • Civic Address | Display the current civic address |
| • ESC ELIN | Display the current ESC ELIN |

4.12.8 LLDP Overloading

The LLDP Port Overloading screen in [Figure 4-12-16](#) appears.

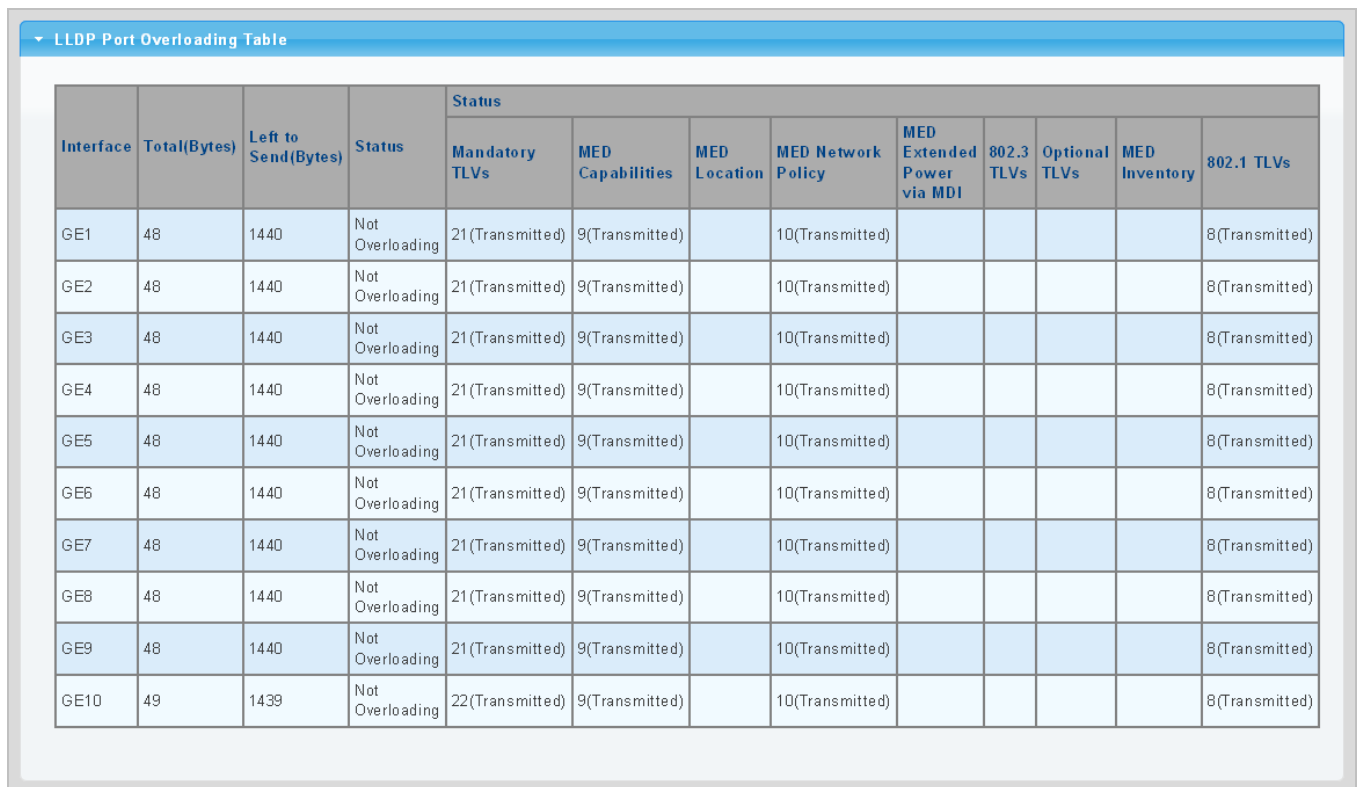

| Interface | Total(Bytes) | Left to Send(Bytes) | Status | Status | | | | | | | | |
|-----------|--------------|---------------------|-----------------|-----------------|------------------|--------------|--------------------|----------------------------|------------|---------------|---------------|----------------|
| | | | | Mandatory TLVs | MED Capabilities | MED Location | MED Network Policy | MED Extended Power via MDI | 802.3 TLVs | Optional TLVs | MED Inventory | 802.1 TLVs |
| GE1 | 48 | 1440 | Not Overloading | 21(Transmitted) | 9(Transmitted) | | 10(Transmitted) | | | | | 8(Transmitted) |
| GE2 | 48 | 1440 | Not Overloading | 21(Transmitted) | 9(Transmitted) | | 10(Transmitted) | | | | | 8(Transmitted) |
| GE3 | 48 | 1440 | Not Overloading | 21(Transmitted) | 9(Transmitted) | | 10(Transmitted) | | | | | 8(Transmitted) |
| GE4 | 48 | 1440 | Not Overloading | 21(Transmitted) | 9(Transmitted) | | 10(Transmitted) | | | | | 8(Transmitted) |
| GE5 | 48 | 1440 | Not Overloading | 21(Transmitted) | 9(Transmitted) | | 10(Transmitted) | | | | | 8(Transmitted) |
| GE6 | 48 | 1440 | Not Overloading | 21(Transmitted) | 9(Transmitted) | | 10(Transmitted) | | | | | 8(Transmitted) |
| GE7 | 48 | 1440 | Not Overloading | 21(Transmitted) | 9(Transmitted) | | 10(Transmitted) | | | | | 8(Transmitted) |
| GE8 | 48 | 1440 | Not Overloading | 21(Transmitted) | 9(Transmitted) | | 10(Transmitted) | | | | | 8(Transmitted) |
| GE9 | 48 | 1440 | Not Overloading | 21(Transmitted) | 9(Transmitted) | | 10(Transmitted) | | | | | 8(Transmitted) |
| GE10 | 49 | 1439 | Not Overloading | 22(Transmitted) | 9(Transmitted) | | 10(Transmitted) | | | | | 8(Transmitted) |

Figure 4-12-16 LLDP Port Overloading Table Page Screenshot

The page includes the following fields:

| Object | Description |
|------------------------|---|
| • Interface | The switch port number of the logical port |
| • Total (Bytes) | Total number of bytes of LLDP information that is normally sent in a packet |
| • Left to Send (Bytes) | Total number of available bytes that can also send LLDP information in a packet |

| | |
|-------------------------------------|--|
| • Status | Gives the status of the TLVs |
| • Mandatory TLVs | Displays if the mandatory group of TLVs were transmitted or overloaded |
| • MED Capabilities | Displays if the capabilities packets were transmitted or overloaded |
| • MED Location | Displays if the location packets were transmitted or overloaded |
| • MED Network Policy | Displays if the network policies packets were transmitted or overloaded |
| • MED Extended Power via MDI | Displays if the extended power via MDI packets were transmitted or overloaded |
| • 802.3 TLVs | Displays if the 802.3 TLVs were transmitted or overloaded |
| • Optional TLVs | If the LLDP MED extended power via MDI packets were sent, or if they were overloaded |
| • MED Inventory | Displays if the mandatory group of TLVs was transmitted or overloaded |
| • 802.1 TLVs | Displays if the 802.1 TLVs were transmitted or overloaded |

4.12.9 LLDP Statistics

Use the LLDP Device Statistics screen to general statistics for LLDP-capable devices attached to the switch, and for LLDP protocol messages transmitted or received on all local interfaces. The LLDP Global and Port Statistics screens in [Figure 4-12-17](#) & [Figure 4-12-18](#) appear.

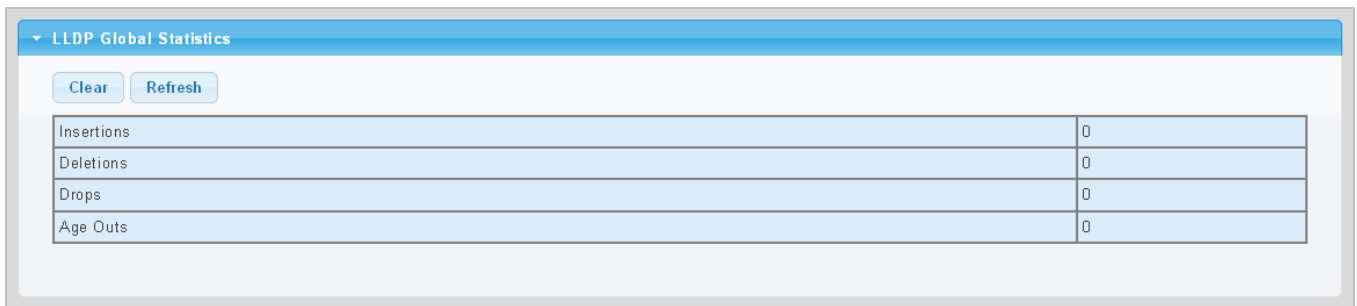
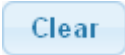

Figure 4-12-17 LLDP Global Statistics Page Screenshot

The page includes the following fields:

| Object | Description |
|---------------------|--|
| • Insertions | Shows the number of new entries added since switch reboot.\ |
| • Deletions | Shows the number of new entries deleted since switch reboot.\ |
| • Drops | Shows the number of LLDP frames dropped due to that the entry table was full.\ |
| • Age Outs | Shows the number of entries deleted due to Time-To-Live expiring.\ |

Buttons



: Click to clear the statistics



: Click to refresh the statistics

| Port | TX Frames | RX Frames | | | RX TLVs | | RX Ageouts |
|------|-----------|-----------|-----------|--------|-----------|--------------|------------|
| | Total | Total | Discarded | Errors | Discarded | Unrecognized | Total |
| GE1 | 136 | 0 | 0 | 0 | 0 | 0 | 0 |
| GE2 | 0 | 0 | 0 | 0 | 0 | 0 | 0 |
| GE3 | 0 | 0 | 0 | 0 | 0 | 0 | 0 |
| GE4 | 0 | 0 | 0 | 0 | 0 | 0 | 0 |
| GE5 | 0 | 0 | 0 | 0 | 0 | 0 | 0 |
| GE6 | 0 | 0 | 0 | 0 | 0 | 0 | 0 |
| GE7 | 0 | 0 | 0 | 0 | 0 | 0 | 0 |
| GE8 | 0 | 0 | 0 | 0 | 0 | 0 | 0 |
| GE9 | 0 | 0 | 0 | 0 | 0 | 0 | 0 |
| GE10 | 0 | 0 | 0 | 0 | 0 | 0 | 0 |

Figure 4-12-18 LLDP Port Statistics Page Screenshot

The page includes the following fields:

| Object | Description |
|--------------------------|---|
| • Port | The port on which LLDP frames are received or transmitted |
| • TX Frame – Total | The number of LLDP frames transmitted on the port |
| • RX Frame – Total | The number of LLDP frames received on the port |
| • RX Frame – Discarded | If an LLDP frame is received on a port, and the switch's internal table has run full, the LLDP frame is counted and discarded. This situation is known as "Too Many Neighbors" in the LLDP standard. LLDP frames require a new entry in the table when the Chassis ID or Remote Port ID is not already contained within the table. Entries are removed from the table when a given port links down, an LLDP shutdown frame is received, or when the entry ages out. |
| • RX Frame – Error | The number of received LLDP frames containing some kind of error. |
| • RX TLVs – Discarded | Each LLDP frame can contain multiple pieces of information, known as TLVs (TLV is short for "Type Length Value"). If a TLV is malformed, it is counted and discarded. |
| • RX TLVs – Unrecognized | The number of well-formed TLVs, but with an unknown type value |
| • RX Ageout - Total | The number of organizationally TLVs received |

4.13 Diagnostics

This section provide the Physical layer and IP layer network diagnostics tools for troubleshoot. The diagnostic tools are designed for network manager to help them quickly diagnose problems between point to point and better service customers.

Use the Diagnostics menu items to display and configure basic administrative details of the LRP Managed Switch. Under System the following topics are provided to configure and view the system information:

This section has the following items:

- **Cable Diagnostics**
- **Ping Test**
- **IPv6 Ping Test**
- **Trace Route**

4.13.1 Cable Diagnostics

The Cable Diagnostics performs tests on copper cables. These functions have the ability to identify the cable length and operating conditions, and to isolate a variety of common faults that can occur on the cat5 twisted-pair cabling. There might be two statuses as follows:

- If the link is established on the twisted-pair interface in 1000BASE-T mode, the Cable Diagnostics can run without disruption of the link or of any data transfer.
- If the link is established in 100BASE-TX or 10BASE-T, the Cable Diagnostics causes the link to drop while the diagnostics is running.

After the diagnostics is finished, the link is reestablished. And the following functions are available:

- Coupling between cable pairs.
- Cable pair termination
- Cable length



Cable Diagnostics is only accurate for cables of length from 15 to 100 meters.

The copper test and test result screens in [Figure 4-13-1](#) & [Figure 4-13-2](#) appear.

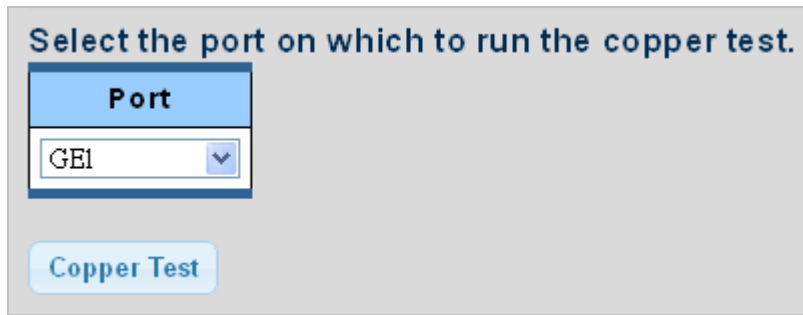

Figure 4-13-1 Copper Test Page Screenshot

The page includes the following fields:

| Object | Description |
|--|--------------------------------------|
| <ul style="list-style-type: none"> Port | Select port from this drop-down list |

Buttons

 : Click to run the diagnostics

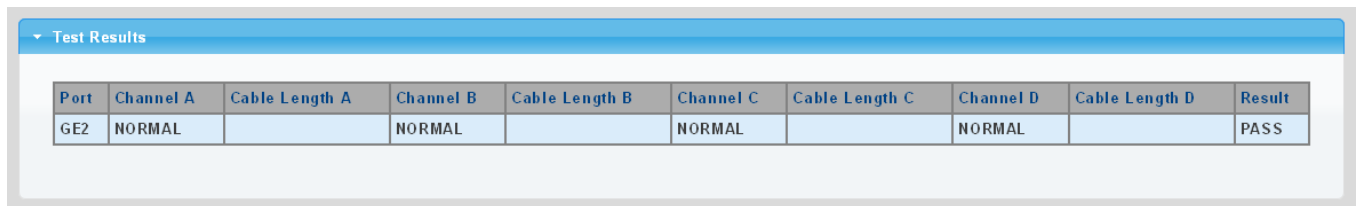

Figure 4-13-2 Test Results Page Screenshot

The page includes the following fields:

| Object | Description |
|--|---|
| <ul style="list-style-type: none"> Port | The port where you are requesting Cable Diagnostics |
| <ul style="list-style-type: none"> Channel A~D | Display the current channel status |
| <ul style="list-style-type: none"> Cable Length A~D | Display the current cable length |
| <ul style="list-style-type: none"> Result | Display the test result |

4.13.2 Ping

The ping and IPv6 ping allow you to issue ICMP ping packets to troubleshoot IP connectivity issues. The LRP Managed Switch transmits ICMP packets, and the sequence number and roundtrip time are displayed upon reception of a reply.

4.13.3 Ping Test

This page allows you to issue ICMP ping packets to troubleshoot IP connectivity issues. After you press “**Apply**”, ICMP packets are transmitted, and the sequence number and roundtrip time are displayed upon reception of a reply. The page refreshes automatically until responses to all packets are received, or until a timeout occurs. The ICMP Ping screen in [Figure 4-13-3](#) appears.

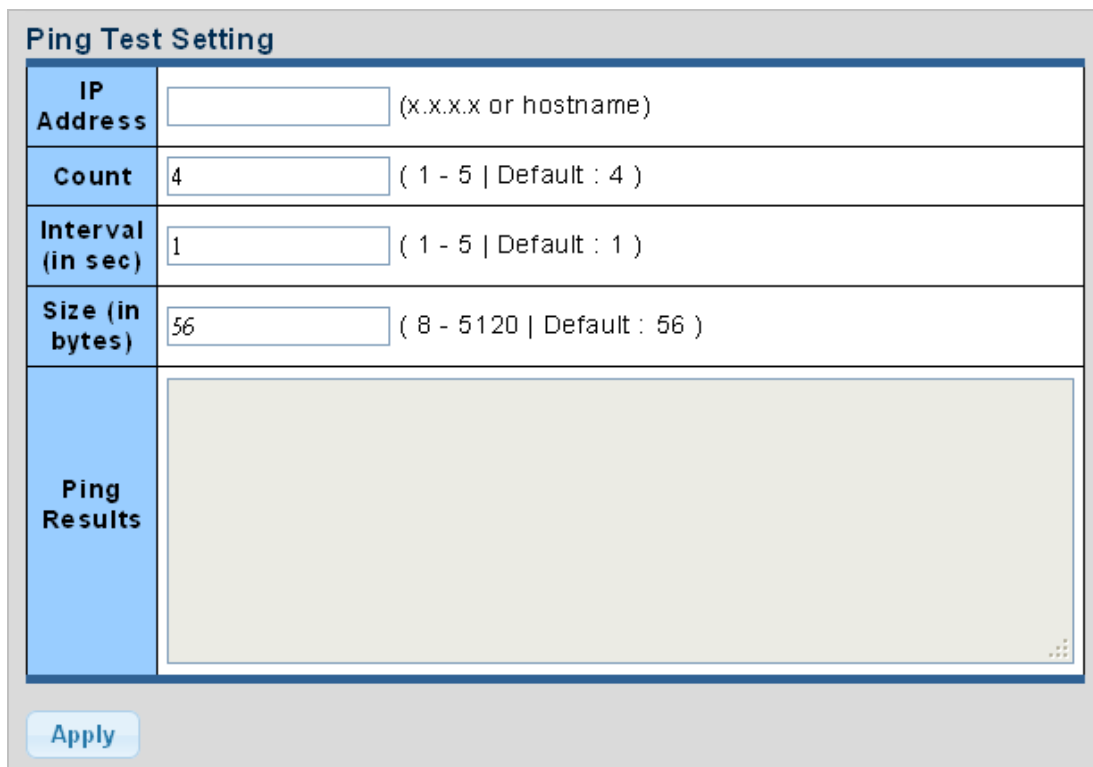

Figure 4-13-3 ICMP Ping Page Screenshot

The page includes the following fields:

| Object | Description |
|---------------------|---|
| • IP Address | The destination IP Address |
| • Count | Number of echo requests to send |
| • Interval (in sec) | Send interval for each ICMP packet |
| • Size (in bytes) | The payload size of the ICMP packet. Values range from 8bytes to 5120bytes. |
| • Ping Results | Display the current ping result. |



Be sure the target IP Address is within the same network subnet of the switch, or you have to set up the correct gateway IP address.

4.13.4 IPv6 Ping Test

This page allows you to issue ICMPv6 PING packets to troubleshoot IPv6 connectivity issues. After you press “**Apply**”, 5 ICMPv6 packets are transmitted, and the sequence number and roundtrip time are displayed upon reception of a reply. The page refreshes automatically until responses to all packets are received, or until a timeout occurs. The ICMPv6 Ping screen in [Figure 4-13-4](#) appears.

Ping test Setting

| | |
|--------------------------|---|
| IPv6 Address | <input style="width: 80%;" type="text" value=""/> (XX:XX:XX:XX) |
| Count | <input style="width: 20%;" type="text" value="4"/> (1 - 5 Default : 4) |
| Interval (in sec) | <input style="width: 20%;" type="text" value="1"/> (1 - 5 Default : 1) |
| Size (in bytes) | <input style="width: 20%;" type="text" value="56"/> (8 - 5120 Default : 56) |
| Ping Results | |

Figure 4-13-4 ICMPv6 Ping Page Screenshot

The page includes the following fields:

| Object | Description |
|----------------------------|--|
| • IP Address | The destination IPv6 Address |
| • Count | Number of echo requests to send |
| • Interval (in sec) | Send interval for each ICMP packet |
| • Size (in bytes) | The payload size of the ICMP packet. Values range from 8bytes to 5120bytes |
| • Ping Results | Display the current ping result |

4.14 RMON

RMON is the most important expansion of the standard SNMP. RMON is a set of MIB definitions, used to define standard network monitor functions and interfaces, enabling the communication between SNMP management terminals and remote monitors. RMON provides a highly efficient method to monitor actions inside the subnets.

MID of RMON consists of 10 groups. The switch supports the most frequently-used groups 1, 2, 3 and 9:

- **Statistics:** Maintain basic usage and error statistics for each subnet monitored by the Agent.
- **History:** Record periodical statistic samples available from Statistics.
- **Alarm:** Allow management console users to set any count or integer for sample intervals and alert thresholds for RMON Agent records.
- **Event:** A list of all events generated by RMON Agent.

Alarm depends on the implementation of Event. Statistics and History display some current or history subnet statistics. Alarm and Event provide a method to monitor any integer data change in the network, and provide some alerts upon abnormal events (sending Trap or record in logs).

4.14.1 RMON Statistics

This page provides a detail of a specific RMON statistics entry; RMON Statistics screen in [Figure 4-14-1](#) appears.

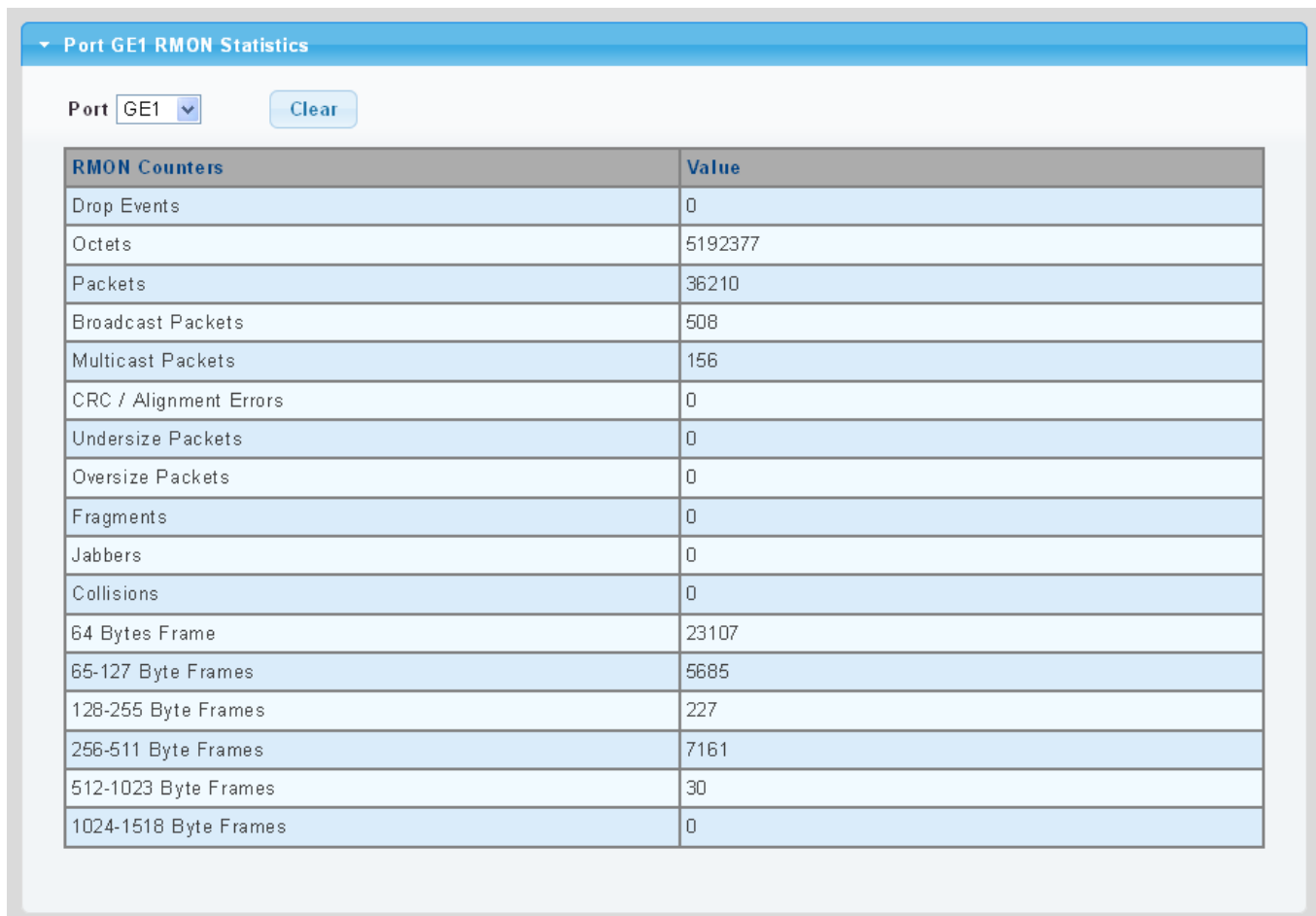

Port

| RMON Counters | Value |
|------------------------|---------|
| Drop Events | 0 |
| Octets | 5192377 |
| Packets | 36210 |
| Broadcast Packets | 508 |
| Multicast Packets | 156 |
| CRC / Alignment Errors | 0 |
| Undersize Packets | 0 |
| Oversize Packets | 0 |
| Fragments | 0 |
| Jabbers | 0 |
| Collisions | 0 |
| 64 Bytes Frame | 23107 |
| 65-127 Byte Frames | 5685 |
| 128-255 Byte Frames | 227 |
| 256-511 Byte Frames | 7161 |
| 512-1023 Byte Frames | 30 |
| 1024-1518 Byte Frames | 0 |

Figure 4-14-1: RMON Statistics Detail Page Screenshot

The page includes the following fields:

| Object | Description |
|--------------------------------|---|
| • Port | Select port from this drop-down list |
| • Drop Events | The total number of events in which packets were dropped by the probe due to lack of resources |
| • Octets | The total number of octets of data (including those in bad packets) received on the network |
| • Packets | The total number of packets (including bad packets, broadcast packets, and multicast packets) received |
| • Broadcast Packets | The total number of good packets received that were directed to the broadcast address |
| • Multicast Packets | The total number of good packets received that were directed to a multicast address |
| • CRC/Alignment Errors | The total number of packets received that had a length (excluding framing bits, but including FCS octets) of between 64 and 1518 octets |
| • Undersize Packets | The total number of packets received that were less than 64 octets |
| • Oversize Packets | The total number of packets received that were longer than 1518 octets |
| • Fragments | The number of frames which size is less than 64 octets received with invalid CRC |
| • Jabbers | The number of frames which size is larger than 64 octets received with invalid CRC |
| • Collisions | The best estimate of the total number of collisions on this Ethernet segment. |
| • 64 Byte Frame | The total number of packets (including bad packets) received that were 64 octets in length |
| • 65~127 Byte Frames | The total number of packets (including bad packets) received that were between 65 to 127 octets in length |
| • 128~255 Byte Frames | The total number of packets (including bad packets) received that were between 128 to 255 octets in length |
| • 256~511 Byte Frames | The total number of packets (including bad packets) received that were between 256 to 511 octets in length |
| • 512~1023 Byte Frames | The total number of packets (including bad packets) received that were between 512 to 1023 octets in length |
| • 1024~1518 Byte Frames | The total number of packets (including bad packets) received that were between 1024 to 1518 octets in length |

Buttons

Clear : Click to clear the RMON statistics

4.14.2 RMON Event

Configure RMON Event table on this page. The RMON Event screens in [Figure 4-14-2](#) & [Figure 4-14-3](#) appear.

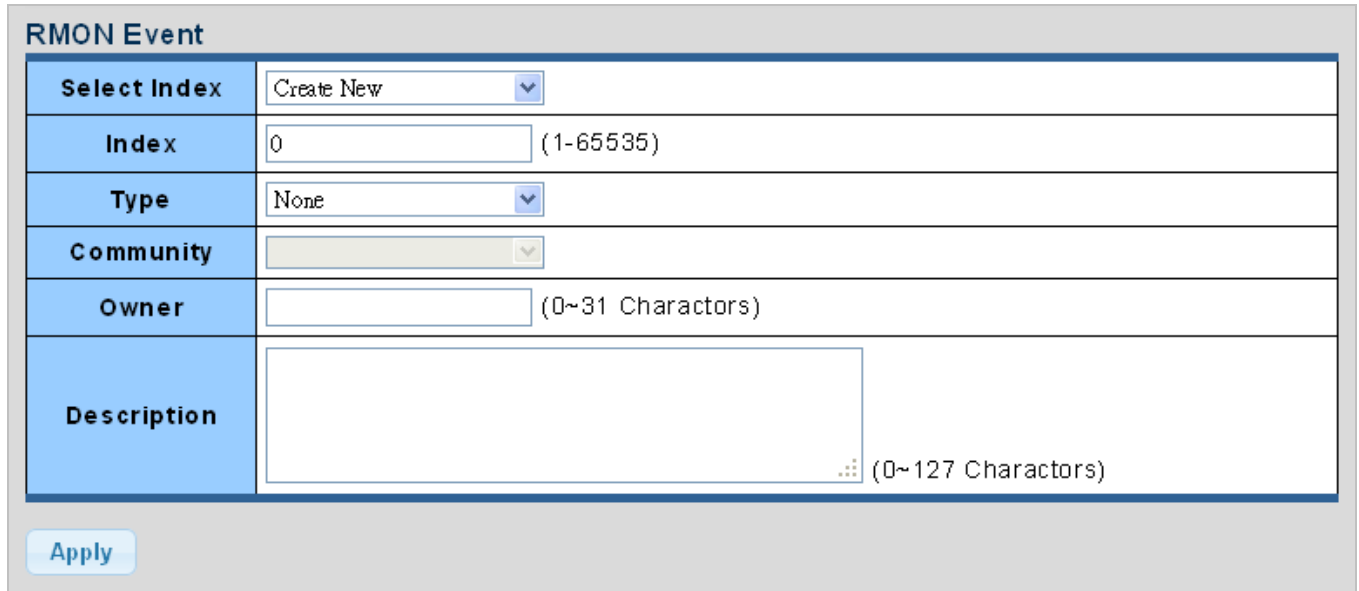



Figure 4-14-2: RMON Event Configuration Page Screenshot

The page includes the following fields:

| Object | Description |
|-----------------------|--|
| • Select Index | Select index from this drop-down list to create new index or modify index |
| • Index | Indicates the index of the entry. The range is from 1 to 65535 |
| • Type | Indicates the notification of the event, the possible types are: <ul style="list-style-type: none"> ■ none: The total number of octets received on the interface, including framing characters. ■ log: The number of uni-cast packets delivered to a higher-layer protocol. ■ SNMP-Trap: The number of broad-cast and multi-cast packets delivered to a higher-layer protocol. ■ Log and Trap: The number of inbound packets that are discarded even the packets are normal. |
| • Community | Specify the community when trap is sent, the string length is from 0 to 127, default is "public". |
| • Owner | Indicates the owner of this event, the string length is from 0 to 127, default is a null string |
| • Description | Indicates description of this event, the string length is from 0 to 127, default is a null string |

Buttons

: Click to apply changes.

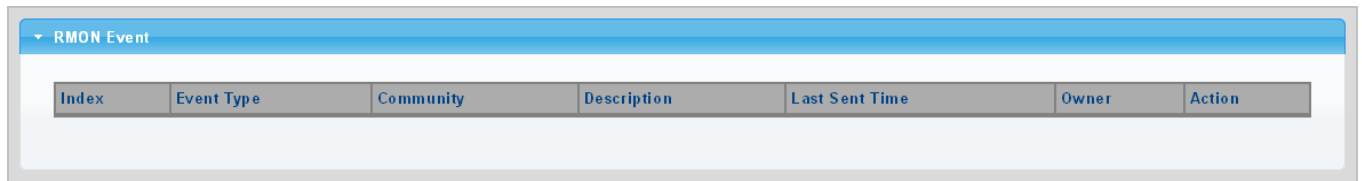



Figure 4-14-3: RMON Event Status Page Screenshot

The page includes the following fields:

| Object | Description |
|-------------------------|--|
| • Index | Display the current event index |
| • Event Type | Display the current event type |
| • Community | Display the current community for SNMP trap |
| • Description | Display the current event description |
| • Last Sent Time | Display the current last sent time |
| • Owner | Display the current event owner |
| • Action | Click  to delete RMON event entry |

4.14.3 RMON Event Log

This page provides an overview of RMON Event Log. The RMON Event Log Table screen in [Figure 4-14-4](#) appears.

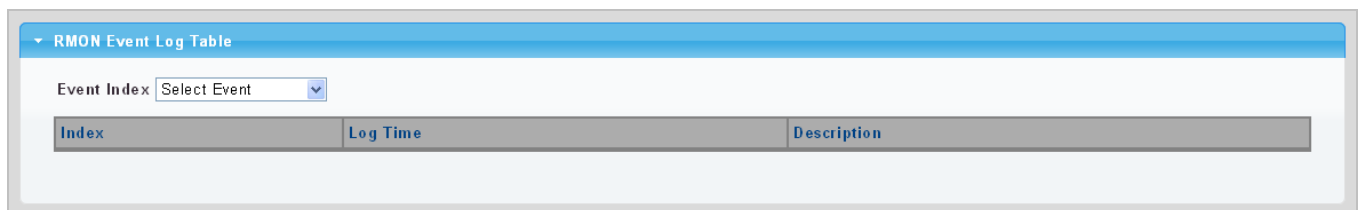

Figure 4-14-4: RMON Event Log Table Page Screenshot

The page includes the following fields:

| Object | Description |
|-----------------------|---------------------------------------|
| • Select Index | Select index from this drop-down list |
| • Index | Indicates the index of the log entry |
| • Log Time | Indicates Event log time |
| • Description | Indicates the Event description |

4.14.4 RMON Alarm

Configure RMON Alarm table on this page. The RMON Alarm screens in [Figure 4-14-5](#) & [Figure 4-14-6](#) appear.

RMON Alarm

| | |
|--------------------------|--|
| Select Index | <input type="text" value="Create New"/> |
| Index | <input type="text" value="0"/> (1-65535) |
| Sample Port | <input type="text" value="GE1"/> |
| Sample Variable | <input type="text" value="DropEvents"/> |
| Sample Interval | <input type="text" value="0"/> (1-2147483647) |
| Sample Type | <input type="radio"/> absolute <input type="radio"/> delta |
| Rising Threshold | <input type="text" value="0"/> (0-2147483647) |
| Falling Threshold | <input type="text" value="0"/> (0-2147483647) |
| Rising Event | <input type="text" value="0: None (Unassigned)"/> |
| Falling Event | <input type="text" value="0: None (Unassigned)"/> |
| Owner | <input type="text"/> (0~31 Charactors) |

Figure 4-14-5: RMON Alarm Table Page Screenshot

The page includes the following fields:

| Object | Description |
|--|---|
| <ul style="list-style-type: none"> • Select Index | Select index from this drop-down list to create the new index or modify the index |
| <ul style="list-style-type: none"> • Index | Indicates the index of the alarm entry |
| <ul style="list-style-type: none"> • Sample Port | Select port from this drop-down list |
| <ul style="list-style-type: none"> • Sample Variable | Indicates the particular variable to be sampled, the possible variables are: <ul style="list-style-type: none"> ■ DropEvents: The total number of events in which packets were dropped due to lack of resources. ■ Octets: The number of received and transmitted (good and bad) bytes. Includes FCS, but excludes framing bits. ■ Pkts: The total number of frames (bad, broadcast and multicast) received and transmitted. ■ BroadcastPkts: The total number of good frames received that were directed to the broadcast address. Note that this does not include multicast |

| | |
|--|--|
| | <p>packets.</p> <ul style="list-style-type: none"> ■ MulticastPkts: The total number of good frames received that were directed to this multicast address. ■ CRCAlignErrors: The number of CRC/alignment errors (FCS or alignment errors). ■ UndersizePkts: The total number of frames received that were less than 64 octets long(excluding framing bits, but including FCS octets) and were otherwise well formed. ■ OversizePkts: The total number of frames received that were longer than 1518 octets (excluding framing bits, but including FCS octets) and were otherwise well formed. ■ Fragments: The total number of frames received that were less than 64 octets in length (excluding framing bits, but including FCS octets) and had either an FCS or alignment error. ■ Jabbers: The total number of frames received that were longer than 1518 octets(excluding framing bits, but including FCS octets), and had either an FCS or alignment error. ■ Collisions: The best estimate of the total number of collisions on this Ethernet segment. ■ Pkts64Octets: The total number of frames (including bad packets) received and transmitted that were 64 octets in length (excluding framing bits but including FCS octets). ■ Pkts64to172Octets: The total number of frames (including bad packets) received and transmitted where the number of octets fall within the specified range (excluding framing bits but including FCS octets). ■ Pkts158to255Octets: The total number of frames (including bad packets) received and transmitted where the number of octets fall within the specified range (excluding framing bits but including FCS octets). ■ Pkts256to511Octets: The total number of frames (including bad packets) received and transmitted where the number of octets fall within the specified range (excluding framing bits but including FCS octets). ■ Pkts512to1023Octets: The total number of frames (including bad packets) received and transmitted where the number of octets fall within the specified range (excluding framing bits but including FCS octets). ■ Pkts1024to1518Octets: The total number of frames (including bad packets) received and transmitted where the number of octets fall within the specified range (excluding framing bits but including FCS octets). |
| <ul style="list-style-type: none"> • Sample Interval | <p>Sample interval (1-2147483647)</p> |

| | |
|--|--|
| <ul style="list-style-type: none"> • Sample Type | <p>The method of sampling the selected variable and calculating the value to be compared against the thresholds, possible sample types are:</p> <ul style="list-style-type: none"> ■ Absolute: Get the sample directly (default). ■ Delta: Calculate the difference between samples. |
| <ul style="list-style-type: none"> • Rising Threshold | Rising threshold value (0–2147483647) |
| <ul style="list-style-type: none"> • Falling Threshold | Falling threshold value (0–2147483647) |
| <ul style="list-style-type: none"> • Rising Event | Event to fire when the rising threshold is crossed |
| <ul style="list-style-type: none"> • Falling Event | Event to fire when the falling threshold is crossed |
| <ul style="list-style-type: none"> • Owner | Specify an owner for the alarm |

Buttons

: Click to apply changes.

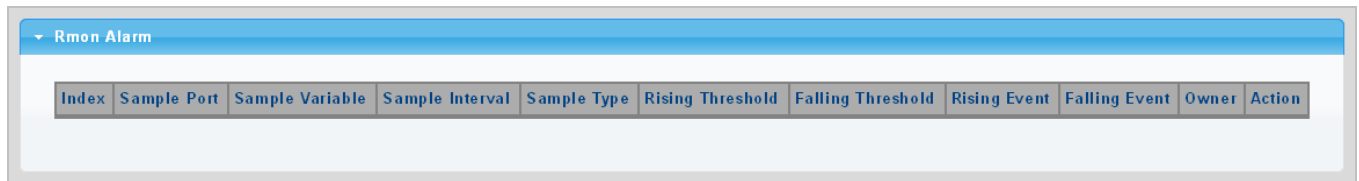



Figure 4-14-6: RMON Alarm Status Page Screenshot

The page includes the following fields:

| Object | Description |
|--|--|
| <ul style="list-style-type: none"> • Index | Indicates the index of Alarm control entry |
| <ul style="list-style-type: none"> • Sample Port | Display the current sample port |
| <ul style="list-style-type: none"> • Sample Variable | Display the current sample variable |
| <ul style="list-style-type: none"> • Sample Interval | Display the current interval |
| <ul style="list-style-type: none"> • Sample Type | Display the current sample type |
| <ul style="list-style-type: none"> • Rising Threshold | Display the current rising threshold |
| <ul style="list-style-type: none"> • Falling Threshold | Display the current falling threshold |
| <ul style="list-style-type: none"> • Rising Event | Display the current rising event |
| <ul style="list-style-type: none"> • Falling Event | Display the current falling event |
| <ul style="list-style-type: none"> • Owner | Display the current owner |
| <ul style="list-style-type: none"> • Action | Click  to delete RMON alarm entry |

4.14.5 RMON History

Configure RMON History table on this page. The RMON History screens in [Figure 4-14-7](#) & [Figure 4-14-8](#) appear.

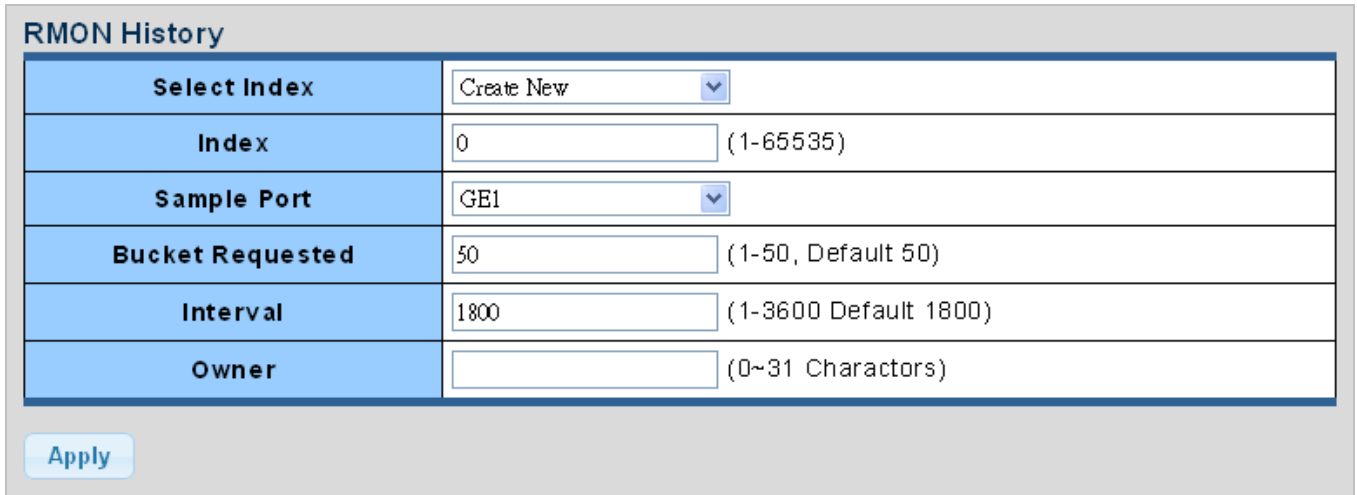

| RMON History | |
|------------------|----------------------------|
| Select Index | Create New |
| Index | 0 (1-65535) |
| Sample Port | GE1 |
| Bucket Requested | 50 (1-50, Default 50) |
| Interval | 1800 (1-3600 Default 1800) |
| Owner | (0~31 Charactors) |

Apply

Figure 4-14-7: RMON History Table Page Screenshot

The page includes the following fields:

| Object | Description |
|--------------------|---|
| • Select Index | Select index from this drop-down list to create the new index or modify the index |
| • Index | Indicates the index of the history entry |
| • Sample Port | Select port from this drop-down list |
| • Bucket Requested | Indicates the maximum data entries associated this History control entry stored in RMON. The range is from 1 to 50, default value is 50 |
| • Interval | Indicates the interval in seconds for sampling the history statistics data. The range is from 1 to 3600, default value is 1800 seconds. |
| • Owner | Specify an owner for the history |

Buttons

: Click to apply changes.

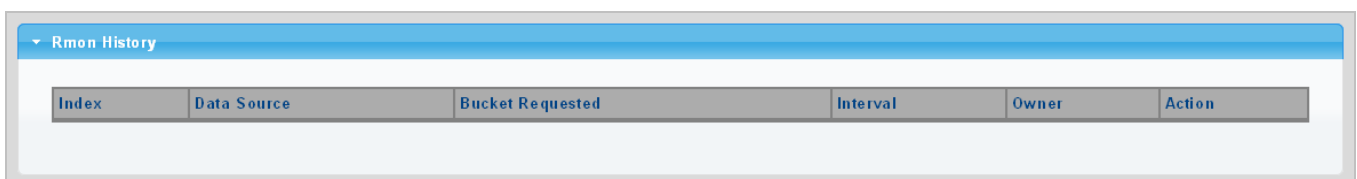

| Rmon History | | | | | |
|--------------|-------------|------------------|----------|-------|--------|
| Index | Data Source | Bucket Requested | Interval | Owner | Action |

Figure 4-14-8: RMON History Status Page Screenshot

The page includes the following fields:

| Object | Description |
|---------------------------|---|
| • Index | Display the current index |
| • Data Source | Display the current data source |
| • Bucket Requested | Display the current bucket requested |
| • Interval | Display the current interval |
| • Owner | Display the current owner |
| • Action | Click  to delete RMON history entry. |

4.14.6 RMON History Log

This page provides a detail of RMON history entries; screen in [Figure 4-14-9](#) appears.

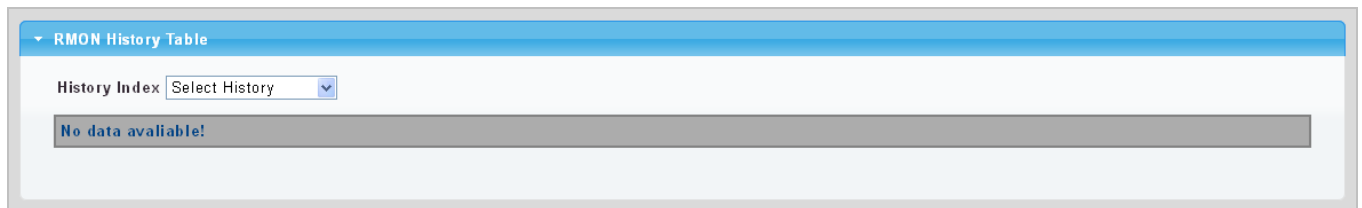

Figure 4-14-9: RMON History Status Page Screenshot

The page includes the following fields:

| Object | Description |
|------------------------|---|
| • History Index | Select history index from this drop-down list |

Buttons

: Click to apply changes.

4.15 Power over Ethernet

The LRP Managed Switch can easily build a power central-controlled IP phone system, IP camera system and AP group for the enterprise. Without the power-socket limitation, the LRP Managed Switch makes the installation of cameras or WLAN APs easier and more efficient.

PoE Power Budget list for LRP Managed Switch

| Model Name | PoE Budget @ 25 degrees C | PoE Budget @ 50 degrees C |
|------------|---------------------------|---------------------------|
| LRP-822CS | 240 watts | 200 watts |
| LRP-1622CS | 440 watts | 380 watts |

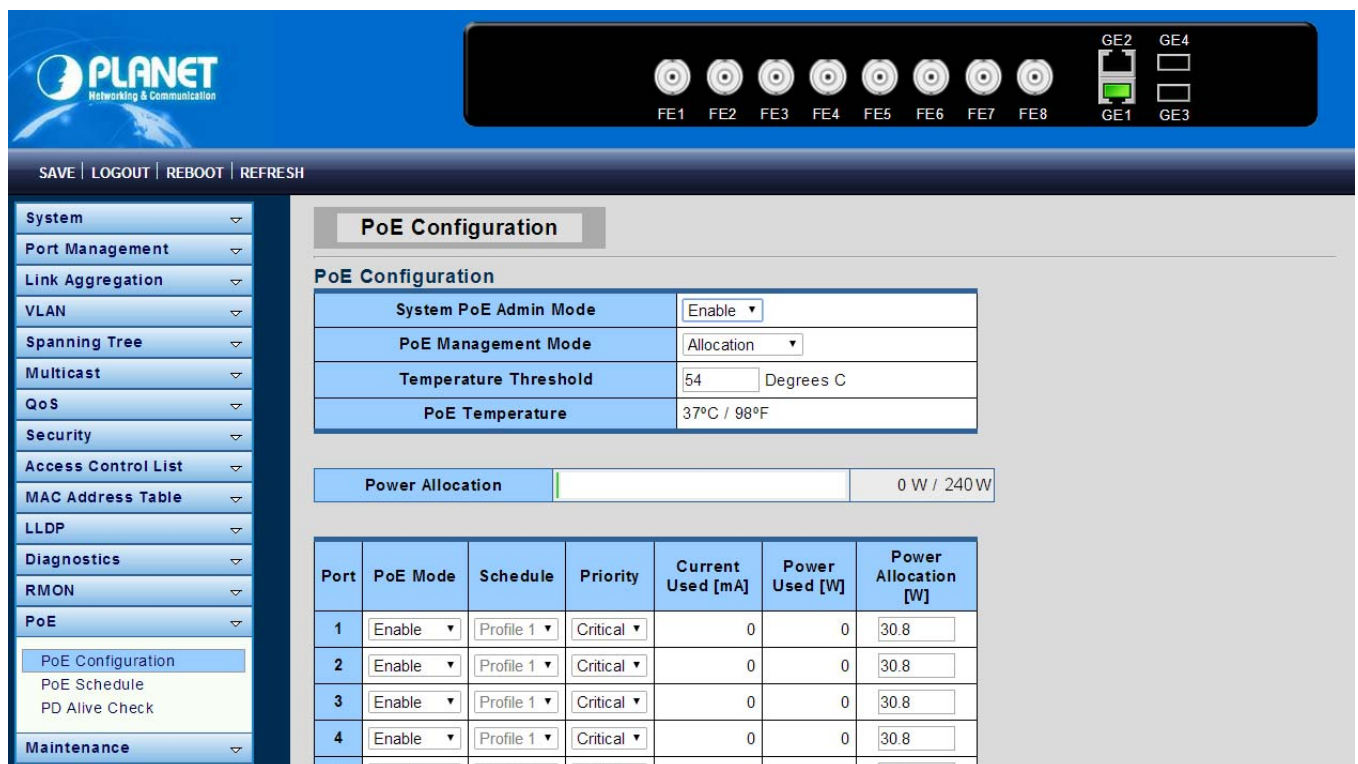

The screenshot shows the PLANET web interface for PoE Configuration. At the top, there are status indicators for ports FE1 through FE8 and GE1 through GE4. The main configuration area includes:

- PoE Configuration:**
 - System PoE Admin Mode: Enable
 - PoE Management Mode: Allocation
 - Temperature Threshold: 54 Degrees C
 - PoE Temperature: 37°C / 98°F
- Power Allocation:** 0 W / 240 W
- Table of Port Status:**

| Port | PoE Mode | Schedule | Priority | Current Used [mA] | Power Used [W] | Power Allocation [W] |
|------|----------|-----------|----------|-------------------|----------------|----------------------|
| 1 | Enable | Profile 1 | Critical | 0 | 0 | 30.8 |
| 2 | Enable | Profile 1 | Critical | 0 | 0 | 30.8 |
| 3 | Enable | Profile 1 | Critical | 0 | 0 | 30.8 |
| 4 | Enable | Profile 1 | Critical | 0 | 0 | 30.8 |

Figure 4-16-1: Power over Ethernet Status

4.15.1 Long Reach Power over Ethernet Powered Device

| | |
|---|---|
|  <p>36 watts (max.)</p> | <p>Long Reach Power over Ethernet Extenders</p> <p>Enterprise can extend IP Ethernet transmission and inject power over an existing coaxial cable for distance up to 1000m (3280ft) to PoE IP camera, PoE wireless AP and any 802.3af/at complied powered device (PD).</p> |
|---|---|

■ Approved PLANET Long Reach PoE Extenders

The following list of approved PLANET Long Reach PoE extenders is correct at the time of publication:

Long Reach Ethernet Coaxial Extenders

- **LRP-101CE** 1-Port 10/100TX PoE PSE + 1-Port Coax Long Reach PoE Extender



It is recommended to use PLANET Long Reach Ethernet coaxial extenders on the LRP Managed Switch. If you insert a coaxial extender that is not supported, the LRP Managed Switch may damage it.

4.15.2 System Configuration

In a power over Ethernet system, operating power is applied from a power source (PSU-power supply unit) over the LAN infrastructure to **powered devices (PDs)**, which are connected to ports. Under some conditions, the total output power required by PDs can exceed the maximum available power provided by the PSU. The system with a PSU is capable of supplying less power than the total potential power consumption of all the PoE ports in the system. In order to maintain the function of the majority of the ports, power management is implemented.

The PSU input power consumption is monitored by measuring voltage and current .The input power consumption is equal to the system's aggregated power consumption .The power management concept allows all ports to be active and activates additional ports, as long as the aggregated power of the system is lower than the power level at which additional PDs cannot be connected .When this value is exceeded, ports will be deactivated, according to user-defined priorities. The power budget is managed according to the following user-definable parameters: maximum available power, ports priority and maximum allowable power per port.

Reserved Power

There are five modes for configuring how the ports/PDs may reserve power and when to shut down ports.

- **Allocation mode**

In this mode, the user allocates the amount of power that each port may reserve. The allocated/reserved power for each port/PD is specified in the Maximum Power fields. The ports are shut down when total reserved power exceeds the amount of power that the power supply can deliver.



In this mode, the port power is not turned on if the PD requests more available power.

4.15.3 Power over Ethernet Configuration

This section allows the user to inspect and configure the current PoE configuration setting as screen in [Figure 4-16-1](#) appears.

| PoE Configuration | |
|-----------------------|--|
| System PoE Admin Mode | Enable <input type="button" value="v"/> |
| PoE Management Mode | Consumption <input type="button" value="v"/> |
| Temperature Threshold | 80 <input type="text"/> Degrees C |
| PoE Temperature | 40°C / 104°F |

Figure 4-16-1: PoE Configuration Screenshot

The page includes the following fields:

| Object | Description |
|--|--|
| <ul style="list-style-type: none"> • System PoE Admin Mode | Allows user to enable or disable PoE function. It will cause all of PoE ports to supply or not to supply power. |
| <ul style="list-style-type: none"> • PoE Management Mode | <p>There are six modes for configuring how the ports/PDs may reserve power and when to shut down ports.</p> <ul style="list-style-type: none"> ■ Consumption mode: The system offers PoE power according to PD real power consumption. ■ Allocation mode: Users allow to assign how much PoE power to each port and the system will reserve PoE power to PD. |
| <ul style="list-style-type: none"> • Temperature Threshold | Allows setting over temperature protection threshold value. If the system temperature is overly high, the system will lower the total PoE power budget automatically. |
| <ul style="list-style-type: none"> • PoE Temperature | Display the PoE Chip Temperature |

This section displays the **PoE Power Usage** of Current Power Consumption as [Figure 4-16-2](#) shows.

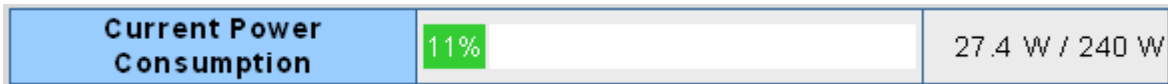

Figure 4-16-2: Current Power Consumption Screenshot

This section allows the user to inspect and configure the current PoE port settings as [Figure 4-16-3](#) shows.

| Port | PoE Mode | Schedule | Priority | Current Used [mA] | Power Used [W] | Power Allocation [W] |
|------|----------|-------------|------------|-------------------|----------------|----------------------|
| 1 | Enable ▼ | Profile 1 ▼ | Critical ▼ | 0 | 0 | 30.8 |
| 2 | Enable ▼ | Profile 1 ▼ | Critical ▼ | 0 | 0 | 30.8 |

Figure 4-16-3: Power over Ethernet Configuration Screenshot

The page includes the following fields:

| Object | Description |
|--|--|
| <ul style="list-style-type: none"> • PoE Mode | <p>There are three modes for PoE mode.</p> <ul style="list-style-type: none"> ■ Enable: enable PoE function. ■ Disable: disable PoE function. ■ Schedule: enable PoE function in schedule mode. |
| <ul style="list-style-type: none"> • Schedule | <p>Indicates the scheduled profile mode. Possible profiles are:</p> <ul style="list-style-type: none"> ■ Profile1 ■ Profile2 ■ Profile3 ■ Profile4 |
| <ul style="list-style-type: none"> • Priority | <p>The Priority represents PoE ports priority. There are three levels of power priority named Low, High and Critical.</p> <p>The priority is used in case the total power consumption is over the total power budget. In this case the port with the lowest priority will be turned off, and offer power for the port of higher priority.</p> |
| <ul style="list-style-type: none"> • Current Used [mA] | <p>The Power Used shows how much current the PD currently is using.</p> |
| <ul style="list-style-type: none"> • Power Used [W] | <p>The Power Used shows how much power the PD currently is using.</p> |
| <ul style="list-style-type: none"> • Power Allocation | <p>It can limit the port PoE supply watts. Per port maximum value must be less than 30.8 watts. Total port values must be less than the Power Reservation value. Once power overload is detected, the port will auto shut down and keep in detection mode until PD's power consumption is lower than the power limit value</p> |

Buttons

: Click to apply changes.

4.15.4 PoE Schedule

This page allows the user to define PoE schedule and scheduled power recycling.

PoE Schedule

Besides being used as an IP Surveillance, the Managed PoE switch is certainly applicable to construct any PoE network including VoIP and Wireless LAN. Under the trend of energy saving worldwide and contributing to the environmental protection on the Earth, the Managed PoE switch can effectively control the power supply besides its capability of giving high watts power. The **"PoE schedule"** function helps you to enable or disable PoE power feeding for each PoE port during specified time intervals and it is a powerful function to help SMB or Enterprise save power and money.

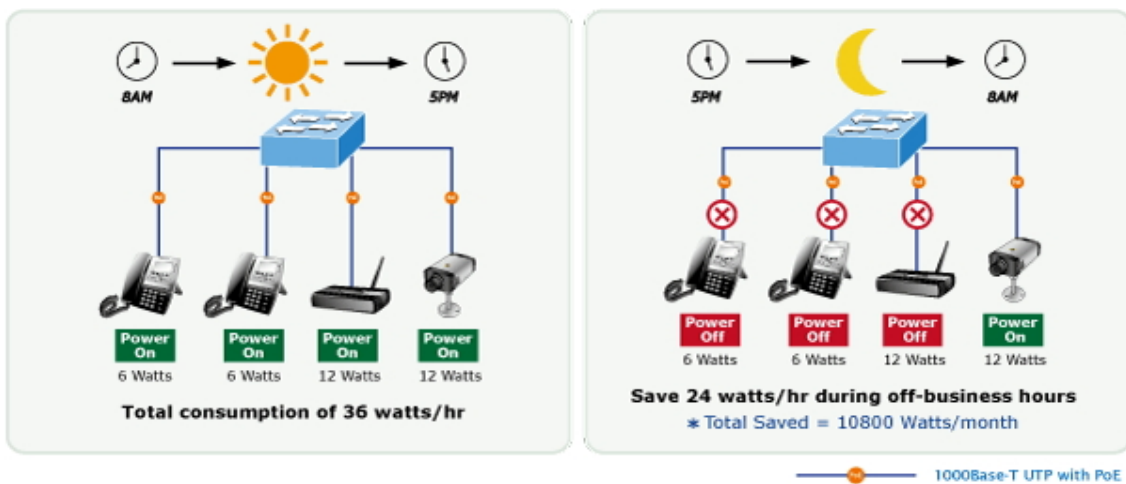

Scheduled Power Recycling

The Managed PoE switch allows each of the connected PoE IP cameras to reboot at a specified time each week. Therefore, it will reduce the chance of IP camera crash resulting from buffer overflow.

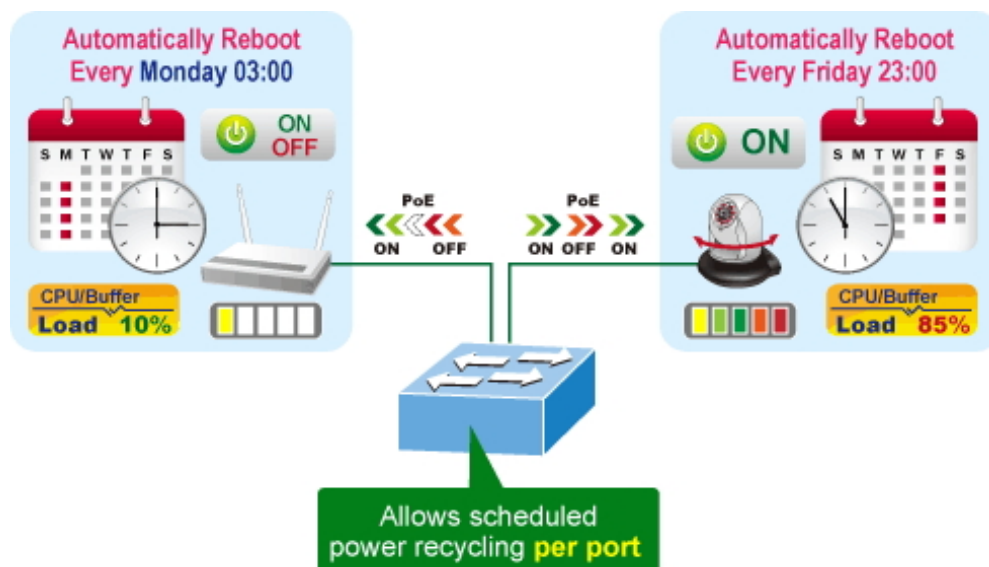

The screen in Figure 4-16-4 appears.

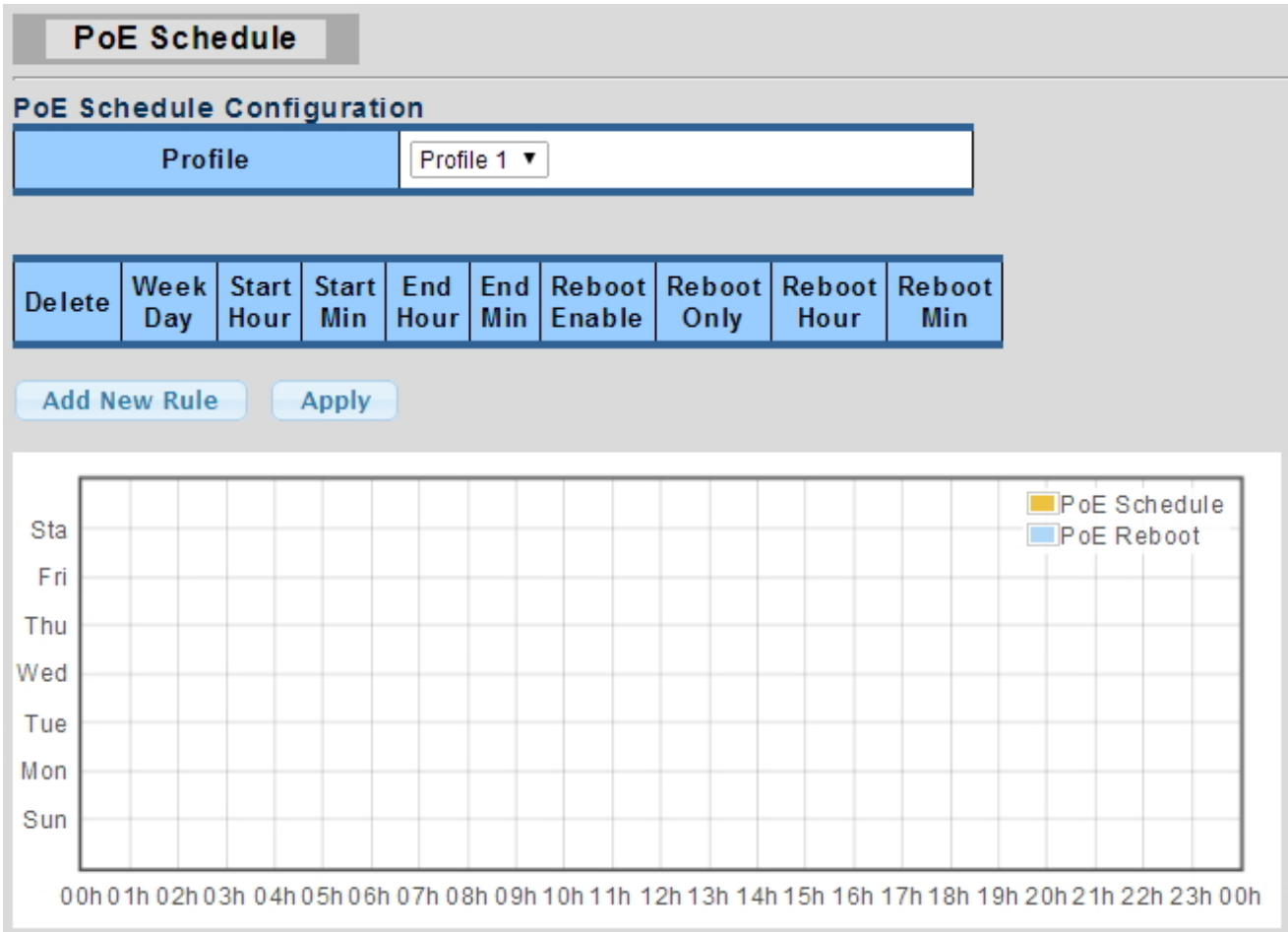

Figure 4-16-4: PoE Schedule Screenshot

Please press the **Add New Rule** button to start setting PoE Schedule function. You have to set PoE schedule to profile and then go back to PoE Port Configuration, and select **“Schedule”** mode from per port **“PoE Mode”** option to enable you to indicate which schedule profile could be applied to the PoE port.

The page includes the following fields:

| Object | Description |
|---|---|
| <ul style="list-style-type: none"> Profile | Set the schedule profile mode. Possible profiles are: Profile1 Profile2 Profile3 Profile4 |
| <ul style="list-style-type: none"> Week Day | Allows user to set week day for defining PoE function by enabling it on the day. |
| <ul style="list-style-type: none"> Start Hour | Allows user to set what hour PoE function does by enabling it. |
| <ul style="list-style-type: none"> Start Min | Allows user to set what minute PoE function does by enabling it. |

| | |
|------------------------|---|
| • End Hour | Allows user to set what hour PoE function does by disabling it. |
| • End Min | Allows user to set what minute PoE function does by disabling it. |
| • Reboot Enable | Allows user to enable or disable the whole PoE port reboot by PoE reboot schedule. Please note that if you want PoE schedule and PoE reboot schedule to work at the same time, please use this function, and don't use Reboot Only function. This function offers administrator to reboot PoE device at an indicated time if administrator has this kind of requirement. |
| • Reboot Only | Allows user to reboot PoE function by PoE reboot schedule. Please note that if administrator enables this function, PoE schedule will not set time to profile. This function is just for PoE port to reset at an indicated time. |
| • Reboot Hour | Allows user to set what hour PoE reboots. This function is only for PoE reboot schedule. |
| • Reboot Min | Allows user to set what minute PoE reboots. This function is only for PoE reboot schedule. |

Buttons

: Click to add new rule.

: Click to apply changes

: Check to delete the entry.

4.15.5 PoE Alive Check Configuration

The PoE Switch can be configured to monitor connected PD's status in real time via ping action. Once the PD stops working and without response, the PoE Switch is going to restart PoE port power, and bring the PD back to work. It will greatly enhance the reliability and reduces administrator management burden.

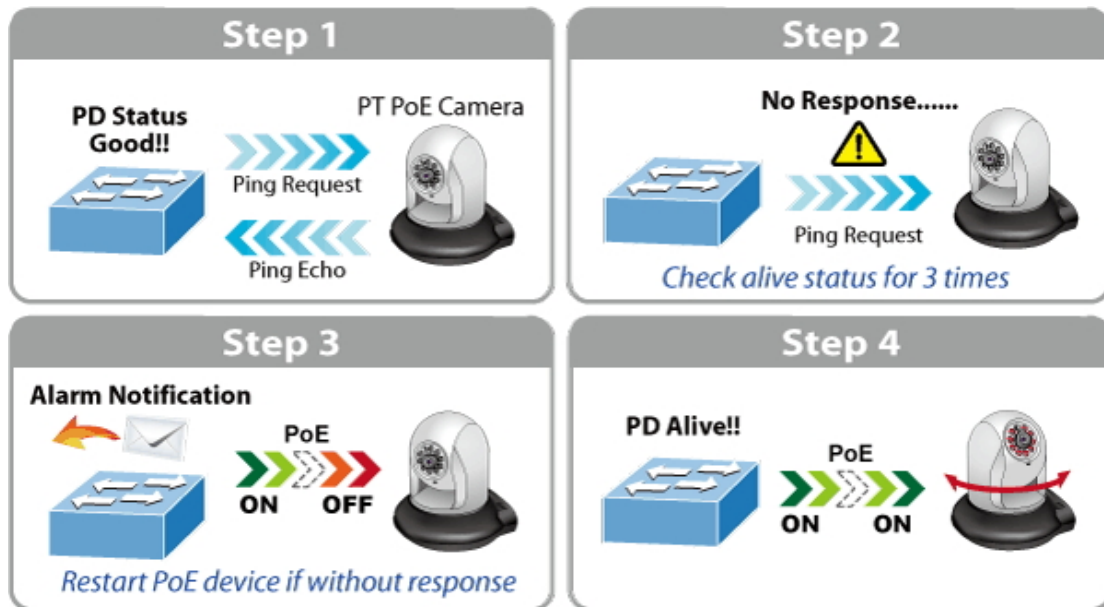

This page provides you with how to configure PD Alive Check. The screen in Figure 4-16-5 appears.

PD Alive Check

PD Alive Check

| Port Select | Mode | Interval Time (10~300s) | Retry Count (1~5) | Action | Reboot Time (30~180s) |
|--------------|---|-------------------------|-------------------|--------|-----------------------|
| Select Ports | <input checked="" type="radio"/> Enabled <input type="radio"/> Disabled | 30 | 2 | None | 90 |

PD Alive Check Configuration

| Port | Mode | Ping PD IP Address | Interval Time [s] | Retry Count | Action | Reboot Time [s] |
|------|----------|---|-------------------|-------------|--------|-----------------|
| 1 | Disabled | <input type="button" value="Edit"/> 0.0.0.0 | 30 | 2 | None | 90 |
| 2 | Disabled | <input type="button" value="Edit"/> 0.0.0.0 | 30 | 2 | None | 90 |
| 3 | Disabled | <input type="button" value="Edit"/> 0.0.0.0 | 30 | 2 | None | 90 |
| 4 | Disabled | <input type="button" value="Edit"/> 0.0.0.0 | 30 | 2 | None | 90 |
| 5 | Disabled | <input type="button" value="Edit"/> 0.0.0.0 | 30 | 2 | None | 90 |
| 6 | Disabled | <input type="button" value="Edit"/> 0.0.0.0 | 30 | 2 | None | 90 |

Figure 4-15-5: PD Alive Check Configuration Screenshot

The page includes the following fields:

| Object | Description |
|--|--|
| <ul style="list-style-type: none"> • Mode | <p>Allows user to enable or disable per port PD Alive Check function. By default, all ports are disabled.</p> |
| <ul style="list-style-type: none"> • Ping PD IP Address | <p>This column allows user to set PoE device IP address for system making ping to the PoE device. Please note that the PD's IP address must be set to the same network segment with the PoE Switch.</p> |
| <ul style="list-style-type: none"> • Interval Time (10~300s) | <p>This column allows user to set how long system should issue a ping request to PD for detecting whether PD is alive or dead. Interval time range is from 10 seconds to 300 seconds.</p> |
| <ul style="list-style-type: none"> • Retry Count (1~5) | <p>This column allows user to set the number of times system retries ping to PD. For example, if we set count 2, it means that if system retries ping to the PD and the PD doesn't response continuously, the PoE port will be reset.</p> |
| <ul style="list-style-type: none"> • Action | <p>Allows user to set which action will be applied if the PD is without any response. The PoE Switch offers the following 3 actions:</p> <ul style="list-style-type: none"> ■ PD Reboot: It means system will reset the PoE port that is connected to the PD. ■ PD Reboot & Alarm: It means system will reset the PoE port and issue an alarm message via Syslog, SMTP. ■ Alarm: It means system will issue an alarm message via Syslog, SMTP. |
| <ul style="list-style-type: none"> • Reboot Time (30~180s) | <p>This column allows user to set the PoE device rebooting time as there are so many kinds of PoE devices on the market and they have a different rebooting time. The PD Alive-check is not a defining standard, so the PoE device on the market doesn't report reboot done information to the PoE Switch. Thus, user has to make sure how long the PD will take to finish booting, and then set the time value to this column. System is going to check the PD again according to the reboot time. If you are not sure of the precise booting time, we suggest you set it longer.</p> |

Buttons



: Click to apply changes.

4.16 Maintenance

Use the Maintenance menu items to display and configure basic configurations of the LRP Managed Switch. Under maintenance, the following topics are provided to back up, upgrade, save and restore the configuration. This section has the following items:

- **Factory Default** You can reset the configuration of the switch on this page.
- **Reboot Switch** You can restart the switch on this page. After restart, the switch will boot normally.
- **Backup Manager** You can back up the switch configuration.
- **Upgrade Manager** You can upgrade the switch configuration.
- **Dual Image** Select active or backup image on this page.

4.16.1 Factory Default

You can reset the configuration of the switch on this page. Only the IP configuration is retained. The new configuration is available immediately, which means that no restart is necessary. The Factory Default screen in [Figure 4-15-1](#) appears and click to reset the configuration to Factory Defaults.



Figure 4-15-1 Factory Default Page Screenshot

After the “**Factory**” button is pressed and rebooted, the system will load the default IP settings as follows:

- Default IP address: **192.168.0.100**
- Subnet mask: **255.255.255.0**
- Default Gateway: **192.168.0.254**
- The other setting value is back to disable or none.



To reset the LRP Managed Switch to the factory default setting, you can also press the hardware reset button on the front panel for about 10 seconds. After the device is rebooted, you can login the management Web interface within the same subnet of 192.168.0.xx.

4.16.2 Reboot Switch

The **Reboot** page enables the device to be rebooted from a remote location. Once the Reboot button is pressed, user has to re-login the Web interface for about 60 seconds. The Reboot Switch screen in [Figure 4-16-2](#) appears and click to reboot the system.



Figure 4-16-2 Reboot Switch Page Screenshot

4.16.3 Backup Manager

This function allows backup of the current image or configuration of the LRP Managed Switch to the local management station. The Backup Manager screen in [Figure 4-16-3](#) appears.

Backup Manager

| | |
|----------------------|---|
| Backup Method | TFTP <input type="button" value="v"/> |
| Server IP | <input type="text"/> (IPv4 or IPv6 Address) |
| Backup Type | <input checked="" type="radio"/> Image <input type="radio"/> Running configuration <input type="radio"/> Startup configuration <input type="radio"/> Backup configuration <input type="radio"/> Flash log <input type="radio"/> Buffered log |
| Image | <input checked="" type="radio"/> vmlinux_poe_test.bix (Active) <input type="radio"/> vmlinux_poe_test.bix (Backup) |

Figure 4-16-3 Backup Manager Page Screenshot

The page includes the following fields:

| Object | Description |
|------------------------|--|
| • Backup Method | Select backup method from this drop-down list. |
| • Server IP | Fill in your TFTP server IP address. |
| • Backup Type | Select backup type. |
| • Image | Select active or backup image. |

Buttons

: Click to back up image, configuration or log.

4.16.4 Upgrade Manager

This function allows reloading of the current image or configuration of the LRP Managed Switch to the local management station. The Upgrade Manager screen in [Figure 4-16-4](#) appears.

Upgrade Manager

| | |
|-----------------------|--|
| Upgrade Method | TFTP <input type="button" value="v"/> |
| Server IP | <input type="text"/> (IPv4 or IPv6 Address) |
| File Name | <input type="text"/> |
| Upgrade Type | <input checked="" type="radio"/> Image <input type="radio"/> Startup Configuration <input type="radio"/> Backup Configuration <input type="radio"/> Running Configuration |
| Image | <input type="radio"/> (Active) <input checked="" type="radio"/> (Backup) |

Figure 4-16-4 Upgrade Manager Page Screenshot

The page includes the following fields:

| Object | Description |
|-------------------------|---|
| • Upgrade Method | Select upgrade method from this drop-down list. |
| • Server IP | Fill in your TFTP server IP address. |
| • File Name | The name of firmware image or configuration. |
| • Upgrade Type | Select upgrade type. |
| • Image | Select active or backup image. |

Buttons

: Click to upgrade image or configuration.

4.16.5 Dual Image

This page provides information about the active and backup firmware images in the device, and allows you to revert to the backup image. The web page displays two tables with information about the active and backup firmware images. The Dual Image Configuration and Information screens in [Figure 4-16-5](#) & [Figure 4-16-6](#) appear.



Figure 4-15-5: Dual Image Configuration Page Screenshot

The page includes the following fields:

| Object | Description |
|--|-----------------------------------|
| <ul style="list-style-type: none"> Active Image | Select the active or backup image |

Buttons



: Click to apply active image.

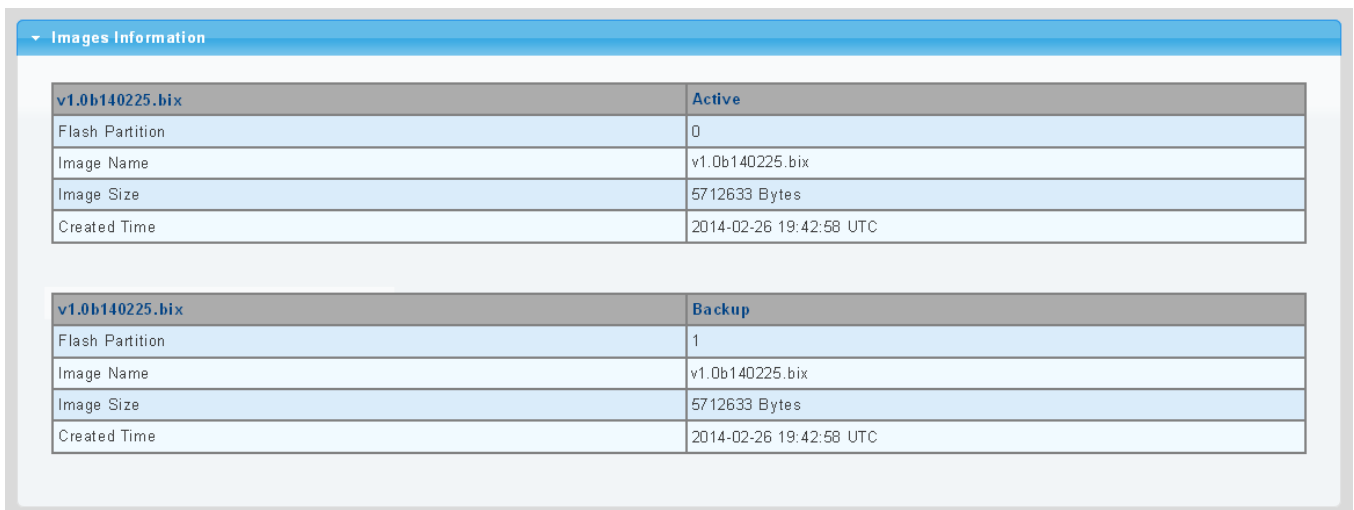

Figure 4-16-6: Dual Image Information Page Screenshot

The page includes the following fields:

| Object | Description |
|---|-------------------------------------|
| <ul style="list-style-type: none"> Flash Partition | Display the current flash partition |
| <ul style="list-style-type: none"> Image Name | Display the current image name |
| <ul style="list-style-type: none"> Image Size | Display the current image size |
| <ul style="list-style-type: none"> Created Time | Display the created time |

5. SWITCH OPERATION

5.1 Address Table

The Switch is implemented with an address table. This address table is composed of many entries. Each entry is used to store the address information of some nodes on the network, including MAC address, port no, etc. This information comes from the learning process of Ethernet Switch.

5.2 Learning

When one packet comes in from any port, the Switch will record the source address, port number and the other related information in the address table. This information will be used to decide either forwarding or filtering for future packets.

5.3 Forwarding & Filtering

When one packet comes from some port of the Ethernet Switching, it will also check the destination address besides the source address learning. The Ethernet Switching will look up the address table for the destination address. If not found, this packet will be forwarded to all the other ports except the port, which this packet comes in. And these ports will transmit this packet to the network it connected. If found, and the destination address is located at a different port from this packet comes in, the Ethernet Switching will forward this packet to the port where this destination address is located according to the information from the address table. But, if the destination address is located at the same port with this packet, then this packet will be filtered, thereby increasing the network throughput and availability

5.4 Store-and-Forward

Store-and-Forward is one type of packet-forwarding techniques. A Store-and-Forward Ethernet Switching stores the incoming frame in an internal buffer and does the complete error checking before transmission. Therefore, no error packets occur. It is the best choice when a network needs efficiency and stability.

The Ethernet Switch scans the destination address from the packet-header, searches the routing table provided for the incoming port and forwards the packet, only if required. The fast forwarding makes the switch attractive for connecting servers directly to the network, thereby increasing throughput and availability. However, the switch is most commonly used to segment existence hubs, which nearly always improves the overall performance. An Ethernet Switching can be easily configured in any Ethernet network environment to significantly boost bandwidth using the conventional cabling and adapters.

Due to the learning function of the Ethernet switching, the source address and corresponding port number of each incoming and outgoing packet is stored in a routing table. This information is subsequently used to filter packets whose destination address is on the same segment as the source address. This confines network traffic to its respective domain and reduces the overall load on the network.

The Switch performs "Store and forward"; therefore, no error packets occur. More reliably, it reduces the re-transmission rate. No packet loss will occur.

5.5 Auto-Negotiation

The STP ports on the Switch have a built-in "Auto-negotiation". This technology automatically sets the best possible bandwidth when a connection is established with another network device (usually at Power On or Reset). This is done by detecting the modes and speeds when both devices are connected. Both 10BASE-T and 100BASE-TX devices can connect with the port in either half- or full-duplex mode.

| If attached device is: | 100BASE-TX port will set to: |
|--|---|
| 10Mbps, without auto-negotiation | 10Mbps. |
| 10Mbps, with auto-negotiation | 10/20Mbps (10BASE-T/full-duplex) |
| 100Mbps, without auto-negotiation | 100Mbps |
| 100Mbps, with auto-negotiation | 100/200Mbps (100BASE-TX/full-duplex) |

6. TROUBLESHOOTING

This chapter contains information to help you solve your issue. If the LRP Managed Switch is not functioning properly, make sure the LRP Managed Switch is set up according to instructions in this manual.

■ The Link LED is not lit

Solution:

Check the cable connection and remove duplex mode of the LRP Managed Switch

■ Some stations cannot talk to other stations located on the other port

Solution:

Please check the VLAN settings, trunk settings, or port enabled / disabled status.

■ Performance is bad

Solution:

Check the full duplex status of the LRP Managed Switch. If the LRP Managed Switch is set to full duplex and the partner is set to half duplex, then the performance will be poor. Please also check the in/out rate of the port.

■ Why the Switch doesn't connect to the network

Solution:

1. Check the LNK/ACT LED on the LRP Managed Switch
2. Try another port on the LRP Managed Switch
3. Make sure the cable is installed properly
4. Make sure the cable is the right type
5. Turn off the power. After a while, turn on power again

■ 100BASE-TX port link LED is lit, but the traffic is irregular

Solution:

Check that the attached device is not set to full duplex. Some devices use a physical or software switch to change duplex modes. Auto-negotiation may not recognize this type of full-duplex setting.

■ Switch does not power up

Solution:

1. AC power cord is not inserted or faulty
2. Check whether the AC power cord is inserted correctly
3. Replace the power cord if the cord is inserted correctly. Check whether the AC power source is working by

connecting a different device in place of the switch.

4. If that device works, refer to the next step.
5. If that device does not work, check the AC power

APPENDIX A

A.1 Switch's RJ45 Pin Assignments

1000Mbps, 1000BASE T

| Contact | MDI | MDI-X |
|---------|--------|--------|
| 1 | BI_DA+ | BI_DB+ |
| 2 | BI_DA- | BI_DB- |
| 3 | BI_DB+ | BI_DA+ |
| 4 | BI_DC+ | BI_DD+ |
| 5 | BI_DC- | BI_DD- |
| 6 | BI_DB- | BI_DA- |
| 7 | BI_DD+ | BI_DC+ |
| 8 | BI_DD- | BI_DC- |

Implicit implementation of the crossover function within a twisted-pair cable, or at a wiring panel, while not expressly forbidden, is beyond the scope of this standard.

A.2 10/100Mbps, 10/100BASE-TX

When connecting your 10/100Mbps Ethernet Switch to another switch, a bridge or a hub, a straight-through or crossover cable is necessary. Each port of the Switch supports auto-MDI/MDI-X detection. That means you can directly connect the Switch to any Ethernet devices without making a crossover cable. The following table and diagram show the standard RJ45 receptacle/connector and their pin assignments:

| RJ45 Connector Pin Assignment | | |
|-------------------------------|----------------------------------|---|
| Contact | MDI Media Dependent Interface | MDI-X Media Dependent Interface-Cross |
| 1 | Tx + (transmit) | Rx + (receive) |
| 2 | Tx - (transmit) | Rx - (receive) |
| 3 | Rx + (receive) | Tx + (transmit) |
| 4, 5 | Not used | |
| 6 | Rx - (receive) | Tx - (transmit) |
| 7, 8 | Not used | |

The standard cable, RJ45 pin assignment

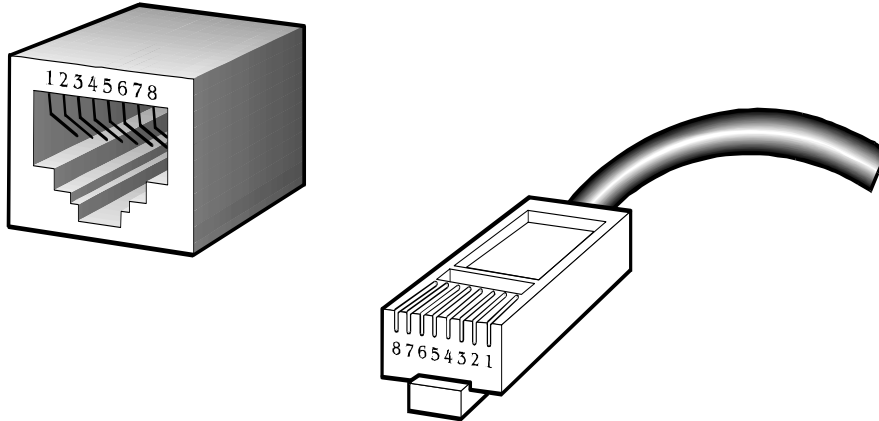

The standard RJ45 receptacle/connector

There are 8 wires on a standard UTP/STP cable and each wire is color-coded. The following shows the pin allocation and color of straight-through cable and crossover cable connection:

| Straight-through Cable | | SIDE 1 | SIDE 2 | | | | | | |
|------------------------|---|--------|--------|---|---|---|---|--|--|
| 1 | 2 | 3 | 4 | 5 | 6 | 7 | 8 | SIDE 1 1 = White / Orange 2 = Orange 3 = White / Green 4 = Blue 5 = White / Blue 6 = Green 7 = White / Brown 8 = Brown SIDE 2 | SIDE 1 1 = White / Orange 2 = Orange 3 = White / Green 4 = Blue 5 = White / Blue 6 = Green 7 = White / Brown 8 = Brown SIDE 2 |
| 1 | 2 | 3 | 4 | 5 | 6 | 7 | 8 | | |
| 1 | 2 | 3 | 4 | 5 | 6 | 7 | 8 | | |
| 1 | 2 | 3 | 4 | 5 | 6 | 7 | 8 | | |
| 1 | 2 | 3 | 4 | 5 | 6 | 7 | 8 | | |
| 1 | 2 | 3 | 4 | 5 | 6 | 7 | 8 | | |
| 1 | 2 | 3 | 4 | 5 | 6 | 7 | 8 | | |
| 1 | 2 | 3 | 4 | 5 | 6 | 7 | 8 | | |
| Crossover Cable | | SIDE 1 | SIDE 2 | | | | | | |
| 1 | 2 | 3 | 4 | 5 | 6 | 7 | 8 | SIDE 1 1 = White / Orange 2 = Orange 3 = White / Green 4 = Blue 5 = White / Blue 6 = Green 7 = White / Brown 8 = Brown SIDE 2 | SIDE 1 1 = White / Green 2 = Green 3 = White / Orange 4 = Blue 5 = White / Blue 6 = Orange 7 = White / Brown 8 = Brown SIDE 2 |
| 1 | 2 | 3 | 4 | 5 | 6 | 7 | 8 | | |
| 1 | 2 | 3 | 4 | 5 | 6 | 7 | 8 | | |
| 1 | 2 | 3 | 4 | 5 | 6 | 7 | 8 | | |
| 1 | 2 | 3 | 4 | 5 | 6 | 7 | 8 | | |
| 1 | 2 | 3 | 4 | 5 | 6 | 7 | 8 | | |
| 1 | 2 | 3 | 4 | 5 | 6 | 7 | 8 | | |
| 1 | 2 | 3 | 4 | 5 | 6 | 7 | 8 | | |

Figure A-1: Straight-through and Crossover Cable

Please make sure your connected cables are with the same pin assignment and color as the above table before deploying the cables into your network.

EC Declaration of Conformity

For the following equipment:

*Type of Product : 8-port Coax + 2-port 10/100/1000T + 2-port 100/1000X SFP
Long Reach PoE over Coaxial Managed Switch

*Model Number : LRP-822CS

* Produced by:
Manufacturer's Name : **Planet Technology Corp.**
Manufacturer's Address : 10F., No.96, Minquan Rd., Xindian Dist.,
New Taipei City 231, Taiwan (R.O.C.).

is herewith confirmed to comply with the requirements set out in the Council Directive on the Approximation of the Laws of the Member States relating to Electromagnetic Compatibility Directive on (2004/108/EC) and Low Voltage Directive 2006/95/EC..

For the evaluation regarding the EMC, the following standards were applied:

| | |
|---------------|--|
| EN 55022 | (2010+AC: 2011) |
| EN 61000-3-2 | (2006+A1:2009+A2:2009) |
| EN 61000-3-3 | (2008) |
| EN 55024 | (2010) |
| EN 61000-4-2 | (2009) |
| EN 61000-4-3 | (2006+A2:2010) |
| EN 61000-4-4 | (2012) |
| EN 61000-4-5 | (2006) |
| EN 61000-4-6 | (2009) |
| EN 61000-4-8 | (2010) |
| EN 61000-4-11 | (2004) |
| EN60950-1 | (2006+A11:2009+A1:2010+A12:2011+A2:2013) |

Responsible for marking this declaration if the:

Manufacturer Authorized representative established within the EU

Authorized representative established within the EU (if applicable):

Company Name: Planet Technology Corp.

Company Address: 10F., No.96, Minquan Rd., Xindian Dist., New Taipei City 231, Taiwan (R.O.C.)

Person responsible for making this declaration

Name, Surname Kent Kang

Position / Title : Product Manager

Taiwan
Place

12th, June, 2015
Date

Legal Signature

PLANET TECHNOLOGY CORPORATION

e-mail: sales@planet.com.tw http://www.planet.com.tw

10F., No.96, Minquan Rd., Xindian Dist., New Taipei City, Taiwan, R.O.C. Tel:886-2-2219-9518 Fax:886-2-2219-9528