

1. Package Contents

Thank you for purchasing PLANET Industrial IP67 1000BASE-X SFP to 10/100/1000BASE-T 802.3at PoE+ Media Converter, IGTP-825AT. In the following sections, the term "Outdoor PoE+ Media Converter" means the IGTP-825AT.

Open the box of the Outdoor PoE+ Media Converter and carefully unpack it. The box should contain the following items:

IGTP-825AT x 1	Power Cable with 2-pin Terminal Block x 1	M22 Waterproof Cable Gland x 3
		
User's Manual x 1	Wall-mounted Kit x 1	Ground Wire x 1
		
	Pincher x 1	Spanner x 1
		
	Pincher for removing transceiver.	
Note		

- 1 -

If any of these are missing or damaged, please contact your dealer immediately; if possible, retain the carton including the original packing material, and use them again to repack the product in case there is a need to return it to us for repair.

2. Hardware Introduction

This section describes the functionalities of the Outdoor PoE+ Media Converter's components.

2.1 Product Outlook

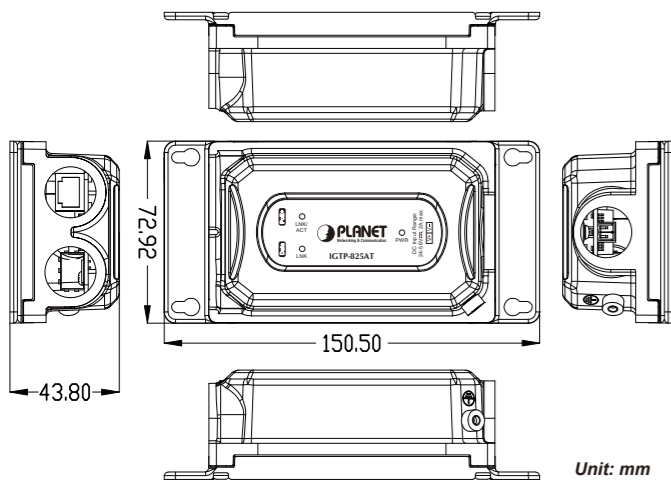

Figure 2-1: IGTP-825AT product outlook

- 2 -

2.2 Power Input Port

Figure 2-2 shows the power input port side of the IGTP-825AT

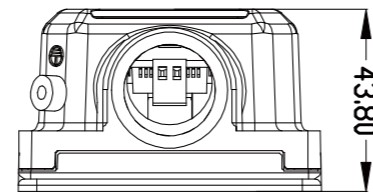

Figure 2-2: IGTP-825AT Power Input port side

2.3 Data Input Port and 802.3at PoE+ Output Port

Figure 2-3 shows the "Data + PoE+" output port and "Data" input port side of the IGTP-825AT.

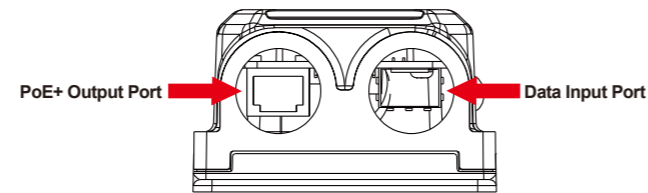

Figure 2-3: IGTP-825AT RJ45 / SFP ports side

- 3 -

2.4 LED Indicators

LED	Color	Function
PWR	Green	Indicates it has power.
LINK/ACT	Green	Lights to indicate the port is linked up at 10/100/1000Mbps. Blinks to indicate that the IGTP-825AT is actively sending or receiving data over that port.
LINK	Green	Indicate the port is linked up at 1000Mbps and actively sending or receiving data over that port.

To install the 2-pin Terminal Block Connector on the **Outdoor PoE+ Media Converter**, simply follow the following steps:

Step 1: Insert positive DC power wire into **V+**, negative DC power wire into **V-**, and grounding wire into **Ground**.

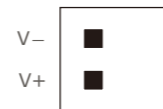

2-pin

Step 2: Tighten the wire-clamp screws for preventing the wires from loosening and plug them into the Outdoor PoE+ Media Converter.

	<ol style="list-style-type: none"> The wire gauge should be in the range from 20 to 22 AWG. The device must be grounded.
Note	

- 4 -

3. Installation

This section describes how to install the Outdoor PoE+ Media Converter and make connections to it. Please read the following sections and perform the procedure in the order being presented.

3.1 Installing Cable Gland with Power Cable and RJ45 UTP Cable

The cable gland consists of the following:

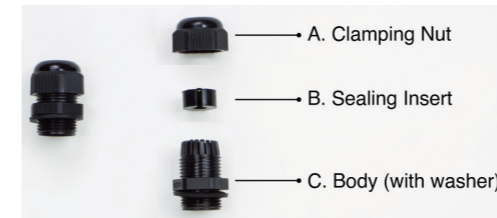

3.2 Connecting Waterproof Cable Kit to the Outdoor PoE+ Media Converter

Step 1: Turn clockwise to tighten the **gland body** connected to the Outdoor PoE+ Media Converter.



- 5 -

Step 2: Plug the power cable connector into the power input port.

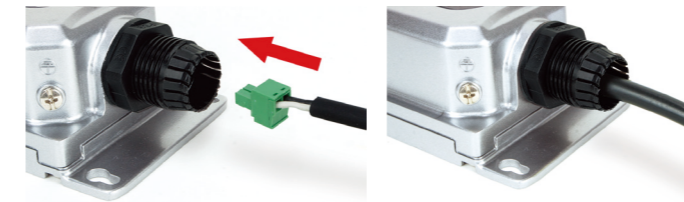

Step 3: Insert the **sealing insert** into the cable gland body.



Step 4: Attach the **clamping nut** to the cable gland to complete the cable assembly.

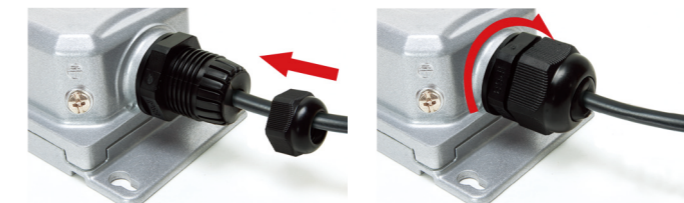

- 6 -

 **Caution** Make sure the clamping nut is tightly attached to the cable gland body and the sealing insert is squeezed tightly.

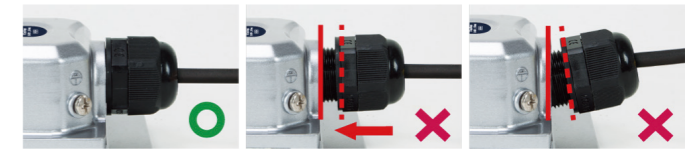

Step 5: Repeat Steps 1 to 4 for "PoE (Data + Power)" Output Port.

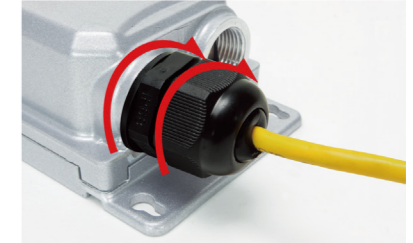

Fiber Cable Gland Installation

Step 6: Insert the SFP transceiver into the "Data" Input Port.

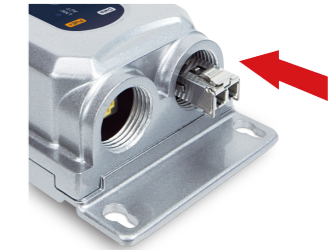

- 7 -

Step 7: Thread the cable gland over the fiber cable in the order as indicated below and attach the two-hole sealing to the fiber cable.

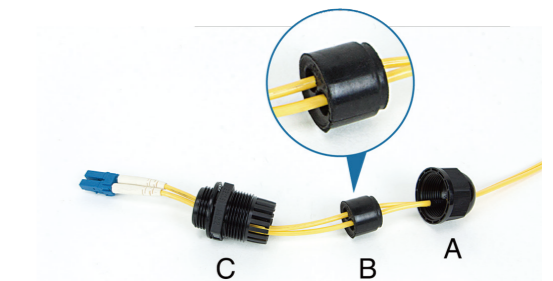

Step 8: Connect the fiber cable to the SFP transceiver.



Step 9: Turn clockwise to tighten the gland body.

- 8 -

Step 10: Repeat Steps 3 and 4



1. Use only the waterproof cable gland provided in the package of the IGTP-825AT.
2. If the above installation procedure is not properly followed, the warranty will be invalidated.

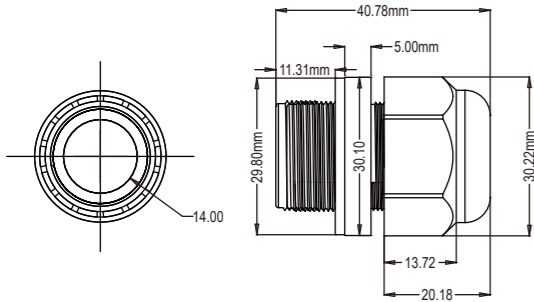

3. If the waterproof cable gland is found missing or damage, please contact your local reseller where you purchased from.
4. Never use any waterproof cable gland that is not purchased from PLANET or doesn't have the same dimensions of the IGTP-825AT; it will damage the device permanently.

- 9 -

3.3 Wall-mount Installation

To install the Outdoor PoE+ Media Converter on the wall, please follow the instructions described below.

Step 1: Find the wall that you want to mount the Outdoor PoE+ Media Converter on.

Step 2: Refer to the picture below to screw the four screws on the wall.

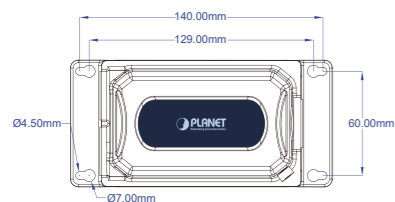

Step 3: Use a screwdriver to screw them into the wall.



3.4 Grounding the Device

Users **MUST** complete grounding wired with the device; otherwise, a sudden lightning could cause fatal damage to the device.

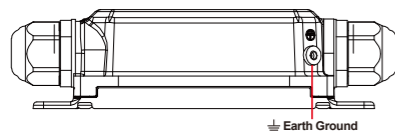

- 10 -



EMD (Lightning) DAMAGE IS NOT COVERED UNDER WARRANTY.

3.5 Connecting IGTP-825AT to PD

Step 1: Connect the additional Cat5e/6 cable from the PoE+ Out of the IGTP-825AT to a remote PD.

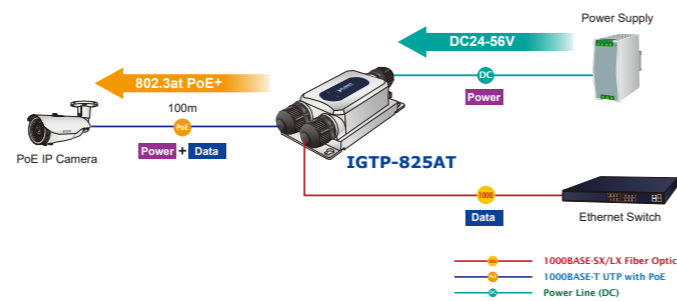

Step 2: The PoE+ Out port is the power injector which transmits DC voltage to the Cat5e/6 cable and transfer data from the Data source.

Step 3: Once the IGTP-825AT detects the existence of an IEEE 802.3at/af device, the LINK/ACT LED indicator will be lit steadily, showing it is providing power.



According to IEEE 802.3at/af standard, the IGTP-825AT will not inject power to the cable if not connected to a standard IEEE 802.3at/af device.

- 11 -

4. Product Specifications

Product	IGTP-825AT		
Hardware Specifications			
Interface	Input Port (SFP Slot)	1 x 1000BASE-SX/LX/BX "Data" in SFP port	
	Output Port	1 x 10/100/1000BASE-T Ethernet with IEEE 802.3at PoE+ "Data + DC" out RJ45 port - Auto MDI/MDI-X, auto-negotiation RJ45 connector	
	Input Power Terminal Block	1 x 2-pin terminal block - Pin 1/2 for Power (Pin 1: V+ / Pin 2: V-)	
Cable	10BASE-T: UTP category 3, 5 cable (≤100m) 100BASE-TX: UTP category 5,5e cable (≤100m) 1000BASE-T: UTP category 5e,6 cable (≤100m) 1000BASE-SX/LX: - Multi-mode: 50/125µm or 62.5/125µm optical fiber - Single-mode: 9/125µm optical fiber		
LED	PWR (Green) TP 10/100/1000BASE-T: LNK/ACT (Green) Fiber 1000BASE-X: LNK (Green)		
Input Voltage	24~56V DC		
Power Consumption	Voltage	System on	Full Load (Max.)
	DC 24V	0.72W	43.4W
	DC 36V	0.72W	41.04W
	DC 54V	1.08W	40.5W

- 12 -



User's Manual

www.PLANET.com.tw

Industrial IP67 1000BASE-X SFP to 10/100/1000BASE-T 802.3at PoE+ Media Converter

IGTP-825AT



PLANET Technology Corp.

10F., No. 96, Minquan Rd., Xindian Dist., New Taipei City 231, Taiwan

Warning:
This device is compliant with Class A of CISPR 32.
In a residential environment this device may cause radio interference.
2351-AH1430-002



ESD Protection	Air 8KV DC Contact 6KV DC
Surge Protection	6KV
Enclosure	IP67-rated and IK10 aluminum metal case
Installation	Wall-mount ear
Dimensions (W x D x H)	150 x 43.8 x 72.94 mm 169.85 x 43.8 x 72.94 mm, with cable gland
Weight	389g
MTBF	>100000 hours
Power over Ethernet	
PoE Standard	IEEE 802.3at Power over Ethernet Plus / End-span PSE Backward compatible with IEEE 802.3af Power over Ethernet
PoE Power Output	55V DC, max. 30 watts
PoE Power Supply Type	End-span
Power Pin Assignment	1/2 (+), 3/6 (-)
PoE Power Budget	30 watts (max.) @ IEEE 802.3at PoE+ input
Standards Conformance	
Regulatory Compliance	FCC Part 15 Class A, CE
Protocols and Standards Compliance	IEEE 802.3 Ethernet IEEE 802.3u Fast Ethernet IEEE 802.3ab Gigabit Ethernet IEEE 802.3z Gigabit Ethernet over Fiber Optic IEEE 802.3x Flow Control IEEE 802.3af Power over Ethernet IEEE 802.3at Power over Ethernet Plus

- 13 -

Stability Testing	IEC 60068-2-32 (Free fall) IEC 60068-2-27 (Shock) IEC 60068-2-6 (Vibration)
Environment	
Temperature	Operating: -40~75 degrees C Storage: -40~85 degrees C
Humidity	Operating: 5~90% (non-condensing) Storage: 5~90% (non-condensing)



The PoE power output ability will depend on the distance.

5. Customer Support

Thank you for purchasing PLANET products. You can browse our online FAQ resource and user's manual on PLANET web site first to check if it could solve your issue. If you need more support information, please contact PLANET support team.

PLANET online FAQs:
<https://www.planet.com.tw/en/support/faq?method=category&c1=2>

Support team mail address:
support@planet.com.tw

Copyright © PLANET Technology Corp. 2022.
Contents are subject to revision without prior notice.
PLANET is a registered trademark of PLANET Technology Corp. All other trademarks belong to their respective owners.

- 14 -