

User's Manual

Z-Wave Ceiling-mount Smoke Detector

▶ HZS-200E/HZS-200A



Copyright

Copyright © 2015 by PLANET Technology Corp. All rights reserved. No part of this publication may be reproduced, transmitted, transcribed, stored in a retrieval system, or translated into any language or computer language, in any form or by any means, electronic, mechanical, magnetic, optical, chemical, manual or otherwise, without the prior written permission of PLANET.

PLANET makes no representations or warranties, either expressed or implied, with respect to the contents hereof and specifically disclaims any warranties, merchantability or fitness for any particular purpose. Any software described in this manual is sold or licensed "as is". Should the programs prove defective following their purchase, the buyer (and not PLANET, its distributor, or its dealer) assumes the entire cost of all necessary servicing, repair, and any incidental or consequential damages resulting from any defect in the software. Further, PLANET reserves the right to revise this publication and to make changes from time to time in the contents hereof without obligation to notify any person of such revision or changes.

All brand and product names mentioned in this manual are trademarks and/or registered trademarks of their respective holders.

Federal Communication Commission Interference Statement

This equipment has been tested and found to comply with the limits for a Class B digital device, pursuant to Part 15 of FCC Rules. These limits are designed to provide reasonable protection against harmful interference in a residential installation. This equipment generates, uses, and can radiate radio frequency energy and, if not installed and used in accordance with the instructions, may cause harmful interference to radio communications. However, there is no guarantee that interference will not occur in a particular installation. If this equipment does cause harmful interference to radio or television reception, which can be determined by turning the equipment off and on, the user is encouraged to try to correct the interference by one or more of the following measures:

1. Reorient or relocate the receiving antenna.
2. Increase the separation between the equipment and receiver.
3. Connect the equipment into an outlet on a circuit different from that to which the receiver is connected.
4. Consult the dealer or an experienced radio technician for help.

FCC Caution

To assure continued compliance, use only shielded interface cables when connecting to computer or peripheral devices. Any changes or modifications not expressly approved by the party responsible for compliance could void the user's authority to operate the equipment.

This device complies with Part 15 of the FCC Rules. Operation is subject to the following two conditions: (1) This device may not cause harmful interference, and (2) this device must accept any interference received, including interference that may cause undesired operation.

Federal Communication Commission (FCC) Radiation Exposure Statement

This equipment complies with FCC radiation exposure set forth for an uncontrolled environment. In order to avoid the possibility of exceeding the FCC radio frequency exposure limits, human proximity to the antenna shall not be less than 20 cm (8 inches) during normal operation.

Safety

This equipment is designed with the utmost care for the safety of those who install and use it. However, special attention must be paid to the dangers of electric shock and static electricity when working with electrical equipment. All guidelines of this and of the computer manufacture must therefore be allowed at all times to ensure the safe use of the equipment.

CE Mark Warning

This is a Class B product. In a domestic environment, this product may cause radio interference, in which case the user may be required to take adequate measures.

WEEE Regulation



To avoid the potential effects on the environment and human health as a result of the presence of hazardous substances in electrical and electronic equipment, end users of electrical and electronic equipment should understand the meaning of the crossed-out wheeled bin symbol. Do not dispose of WEEE as unsorted municipal waste and have to collect such WEEE separately.

Revision

User's Manual of PLANET Z-Wave Ceiling-mount Smoke Detector
Model: HZS-200
Rev: 1.00 (October, 2015)
Part No. EM-HZS-200 Series_v1.0.doc

Table of Contents

Chapter 1. Product Introduction	5
1.1 Package Contents.....	5
1.2 Overview.....	5
1.3 Specifications.....	7
Chapter 2. Hardware Interface.....	8
Chapter 3. Z-Wave Device Setting.....	9
3.1 Configuring Z-Wave Device via Web	9
3.2 Configuring Z-Wave via Smart Phone.....	12
3.3 Configuring Z-Wave via HTS-1000P	17
Appendix A: Troubleshooting & Frequently Asked Questions.....	26

Chapter 1. Product Introduction

1.1 Package Contents

The package should contain the following:

- Smoke Detector x 1
- Quick Installation Guide x 1
- CR123A Lithium Battery x 1
- Bracket Holder x 1
- Screw Kit x 1



Note

If any of the above items are missing, please contact your seller immediately.

1.2 Overview

Home Automation and Smart Home Control

The HZS (Z-Wave Sensing Device) series of PLANET Home Automation product family, based on Z-Wave technology, provides the advanced security system that protects your home and family 24/7. Easy operation and flexible configuration are the attractive features of our system; the simple one-touch button lets you program your regular settings according to your preference and operation mode. Worked with PLANET HAC-1000 Z-Wave Home Automation Control Gateway, you get the all-round and reliable home security services that we offer. Our full range of product lines ensure that you get all the devices you need for your home security system.



Vocal Smoke Alarm Horn

PLANET HZS-200 is a Photoelectric Smoke Detector whose alarm of 85dB will be triggered upon detection of smoke coming from a fire or other burning sources. The alarm signal is then picked up by PLANET HAC-1000 Control Gateway where you will be remotely alerted of the situation via mobile devices, such as smart phone and tablet. The quickness of the alert can certainly stop the situation from becoming worse, thereby protecting your home from the would-be tragedy.



Getting Started is as Easy as 1-2-3

1. Via the Cloud Home App (including Home Automation Controller Pad and Control Gateway), press **Inclusion/Exclusion** to include/exclude Z-Wave device.
2. On the Z-Wave device, press the **Pair** button to establish a connection with the control gateway.
3. Users can enjoy and manage Z-Wave network right away.

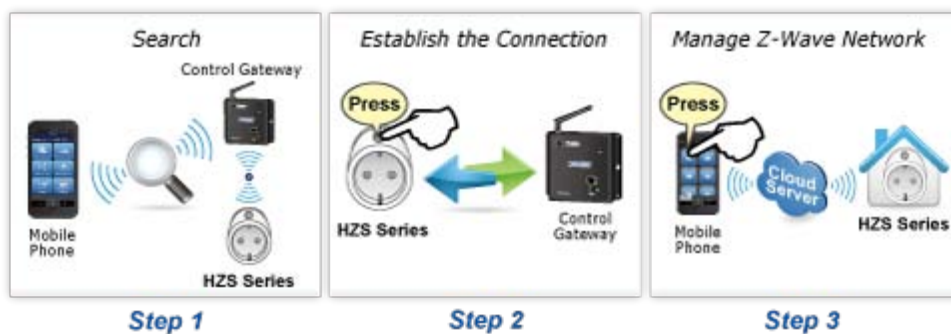

Easy Installation and Convenient Status Indicator

The HYS-200 can be easily installed by ceiling mounted or wall mounted. It also provides various LED light signals for you to conveniently recognize its different statuses directly, such as standby mode, tamper switch alert, low battery warning and error detection, without logging in to its configuration interface.



1.3 Specifications

Product	HYS-200A	HYS-200E
Hardware and Network		
Z-Wave Frequency	America: 908.42MHz	Europe: 868.42MHz
Sensor	Photoelectric	
Buzzing Sound Level	85dB, 3m distance	
LED Indicators	Red: Standby mode, low battery warning Yellow: Tamper switch alert, low battery warning, error detection	
Operating Range	Up to 30 meters in open space	
Installation	Wall mount, 4 to 6 inches from the ceiling suggested Ceiling mount Indoor use only	
General		
Power Requirements	CR123A 3V	
Operating Temperature	0 ~ 49 degrees C	
Operating Humidity	10 ~ 95% (non-condensing)	
Weight	144g	
Dimensions (Φ x L)	120 x 48.7 mm	
Emission	CE, FCC	

Chapter 2. Hardware Interface

Model	HYS-200E/HYS-200A
Dimensions (W x D x H)	120 x 48.7 mm
Weight	144g (gross weight)

➤ **Front Panel**

LED/Test/Program switch

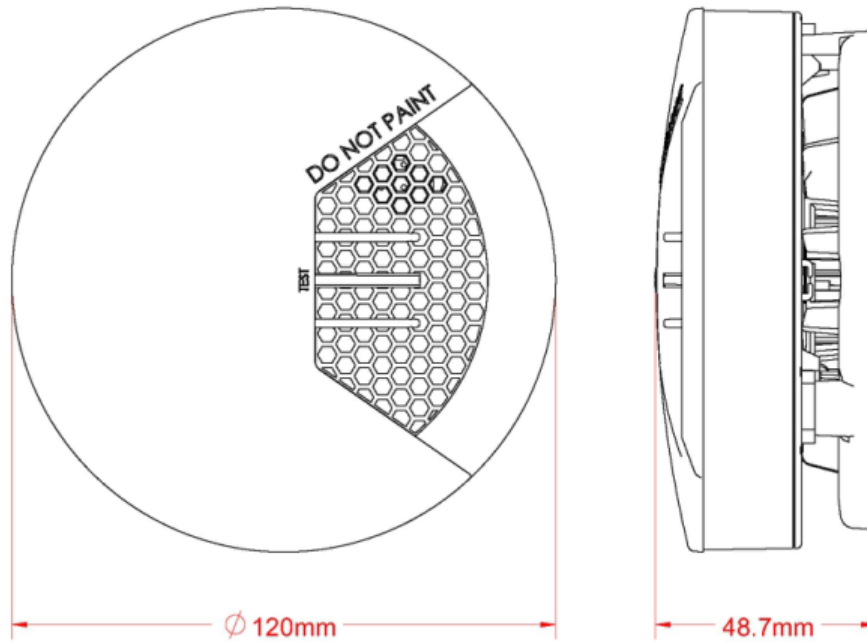

Interface	Description
LED	Red: Standby mode, low battery warning Yellow: Tamper switch alert, low battery warning, error detection *For more details of indicator, refer to HYS-200 user manual.
Test	Set the Silence Feature and check whether this device got crash or ready.
Program switch	Press to include or exclude a Z-Wave network.

Chapter 3. Z-Wave Device Setting

3.1 Configuring Z-Wave Device via HAC-1000

Please refer to the following steps to add Z-Wave device via HAC-1000 web.

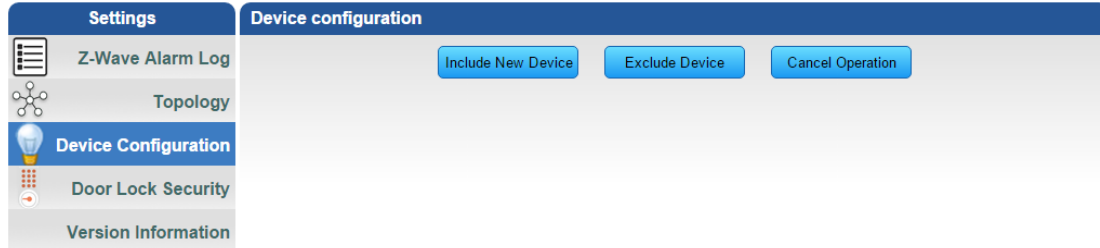

Step 1. Include a Z-Wave device via web.

- a) Go to "Z-Wave" and click "Device Configuration".
- b) Click "Include New Device" and the screen will appear with "Add Device: Waiting for a user action."
- c) The distance between HZS-200 and HAC-1000 is suggested to be in one meter. Press the program switch of HZS-200 for 1 second at least to be included.



- d) If your device has successfully been added, it will show "Add Device: Command has been completed successfully".

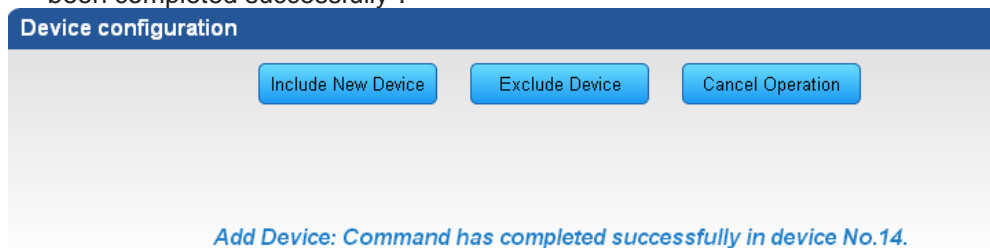

Note

If the device didn't add successfully, please place the device next to the gateway and try again.

Step 2. Set up the location and room for Z-Wave device via HAC-1000 web.

a. Create rooms in your environment.

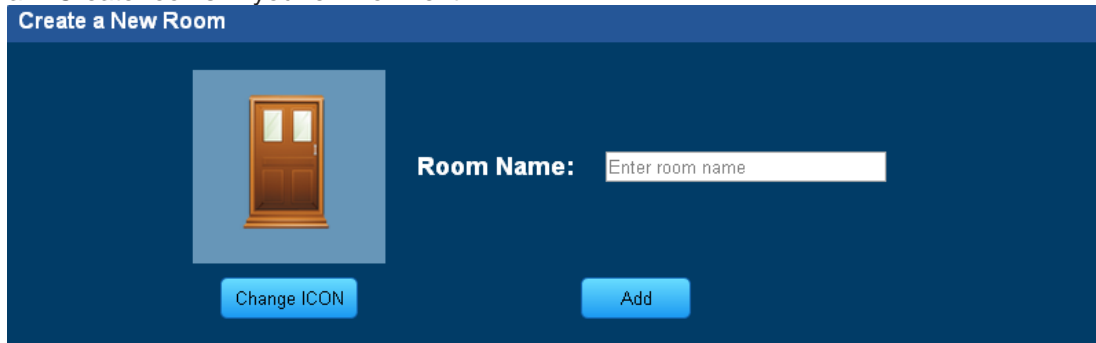

The screenshot shows a web interface titled "Create a New Room". On the left, there is a placeholder image of a door. Below it is a "Change ICON" button. To the right of the image is a "Room Name:" label followed by a text input field containing the placeholder text "Enter room name". Below the input field is an "Add" button.

b. Edit device.

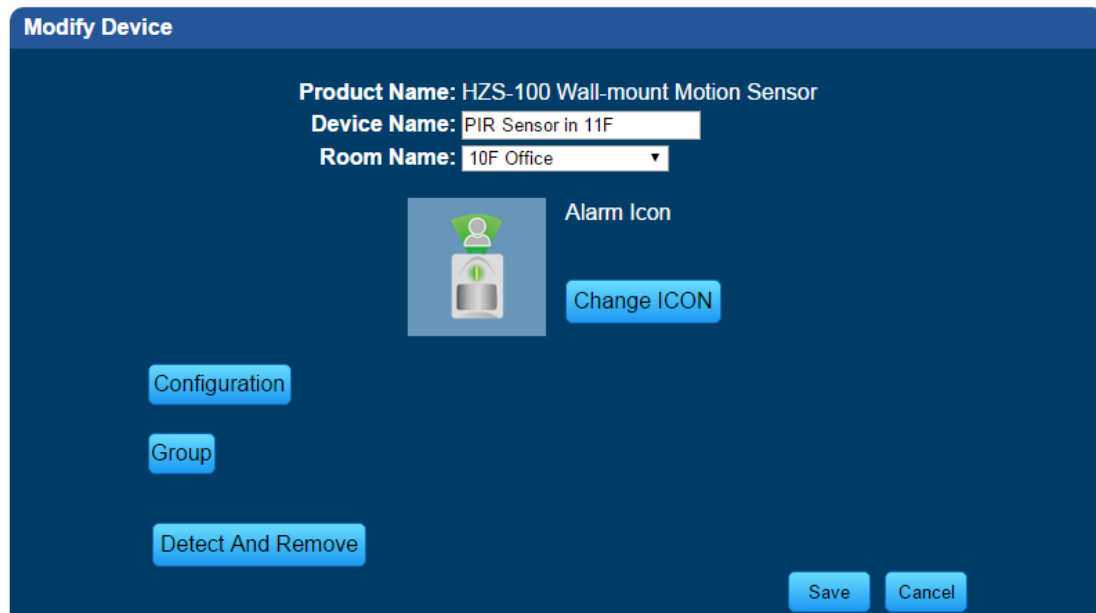

The screenshot shows a web interface titled "Modify Device". It displays the following information: "Product Name: HZS-100 Wall-mount Motion Sensor", "Device Name: PIR Sensor in 11F" (in a text input field), and "Room Name: 10F Office" (in a dropdown menu). Below this is an "Alarm Icon" section with a placeholder image of a sensor and a "Change ICON" button. At the bottom, there are four buttons: "Configuration", "Group", "Detect And Remove", "Save", and "Cancel".

Step 3. Create a scene via web.

a. Click "Create Scene" and name new scene.

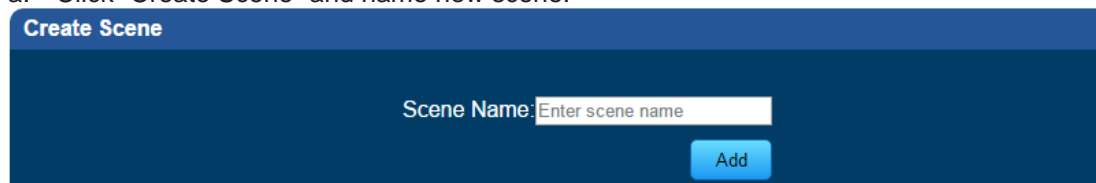

The screenshot shows a web interface titled "Create Scene". It features a "Scene Name:" label followed by a text input field containing the placeholder text "Enter scene name". Below the input field is an "Add" button.

b. Select a device from this scene.

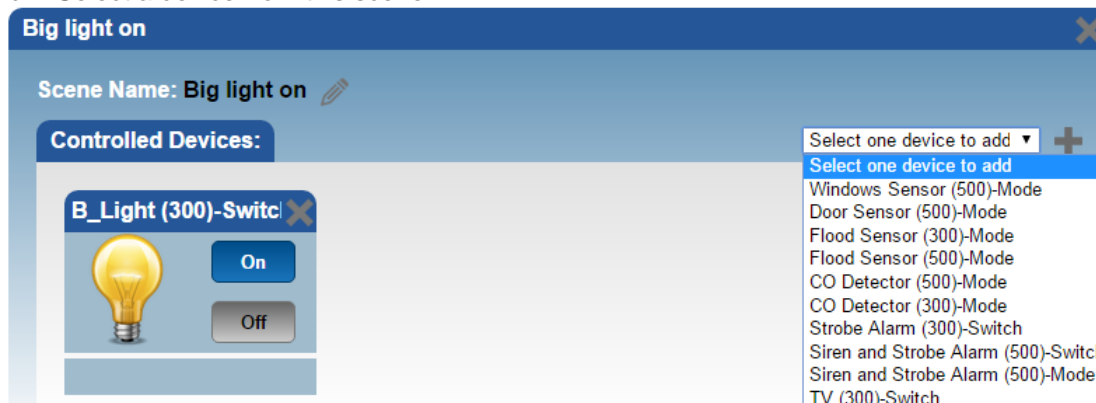

The screenshot shows a web interface titled "Big light on" for editing a scene. The "Scene Name: Big light on" is displayed with an edit icon. Under the "Controlled Devices:" section, a device "B_Light (300)-Switch" is shown with a lightbulb icon and "On" and "Off" buttons. To the right, a dropdown menu is open, showing a list of devices to add: "Windows Sensor (500)-Mode", "Door Sensor (500)-Mode", "Flood Sensor (300)-Mode", "Flood Sensor (500)-Mode", "CO Detector (500)-Mode", "CO Detector (300)-Mode", "Strobe Alarm (300)-Switch", "Siren and Strobe Alarm (500)-Switch", "Siren and Strobe Alarm (500)-Mode", and "TV (300)-Switch".

- c. Select ON or OFF from this scene.

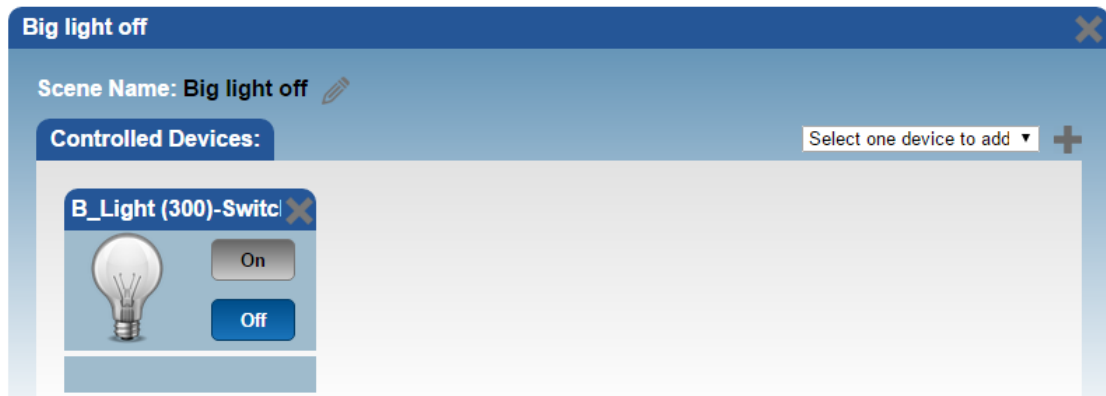

- d. You can click "RUN" to run this scene.

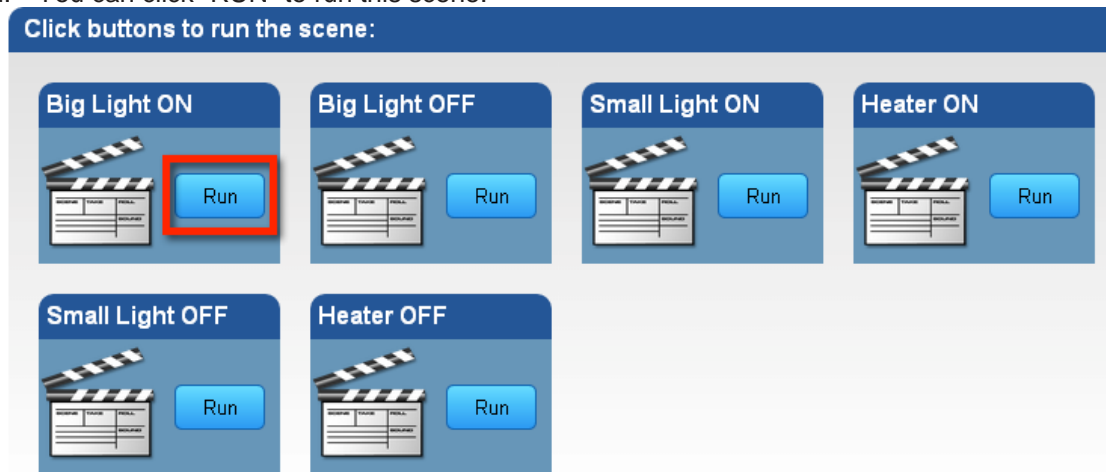

Step 4. Create trigger via web.

- Click "Create a Trigger" and name new trigger.
- Select a Z-Wave device for this trigger.
- Select when it triggers, it will alarm or bypass.
- Select when it triggers, it will run which scene.

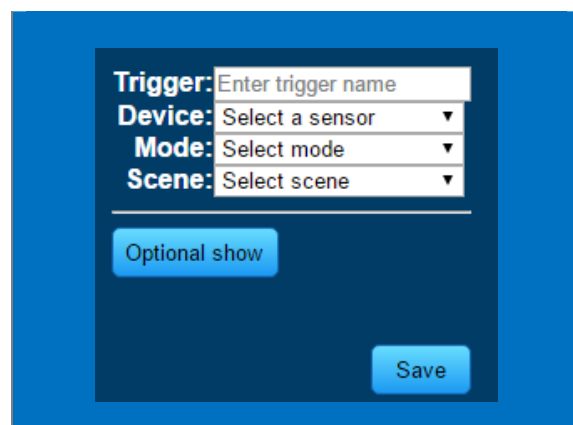

After entering the time selected for the scene to trigger, tick “Save and send alarm notification”. Tick “Active” to enable this trigger.

Trigger	PIR Motion
PIR Motion	Trigger: PIR Motion Device: PIR Motion (300) ▾ Mode: Alarm ▾ Scene: Siren on for door/winc ▾
3-in-1	Optional hide
Windows	After 5 / Seconds to run Siren off for ▾
Door	Save and send alarm notification: <input checked="" type="checkbox"/>
CO (500)	Active: <input checked="" type="checkbox"/>
CO (300)	Test Modify
Flood (300)	
Flood (500)	
Create Trigger	

3.2 Configuring Z-Wave via Smart Phone

The HAC-1100 can be used on iOS and Android operating system. **Cloud Home** can be downloaded at Google Play store or app store.

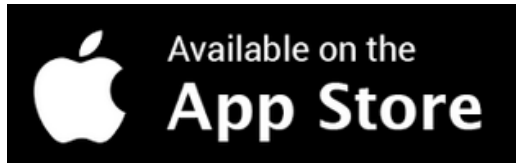
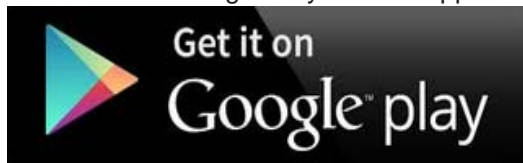

Please refer to the following steps to install **Cloud Home** app and add Z-Wave device via smart phone.

Step 1. Include a Z-Wave device via smart phone (Android/iOS).

a. Register a user account.

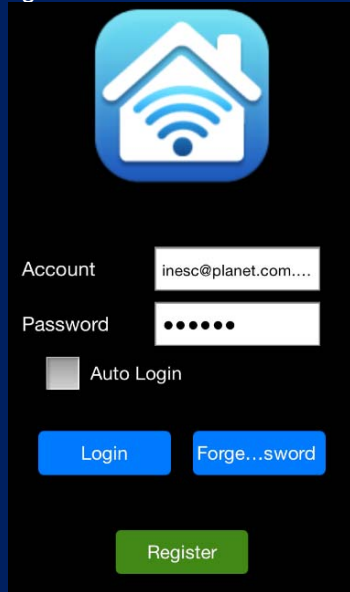

b. Setting



c. Inclusion/Exclusion

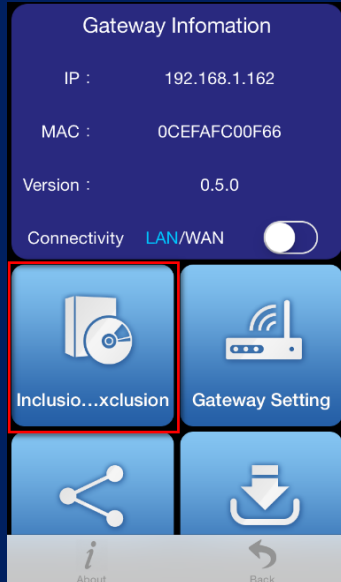

d. Click Inclusion to add device

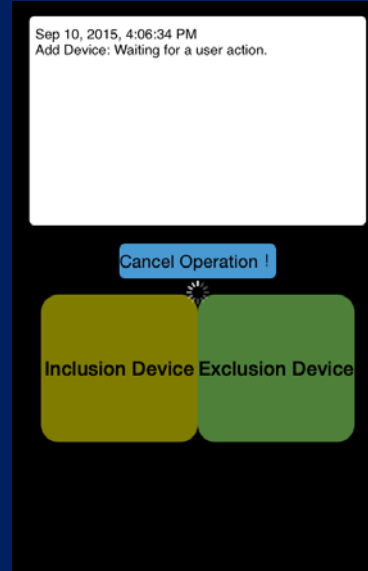

e. The distance between HZS-200 and HAC-1000 is suggested to be one meter. Press the program switch of the HZS-200 at least for 1 second to be included.



Step 2. Set up the location and room for Z-Wave device.

a. Create rooms in your environment.

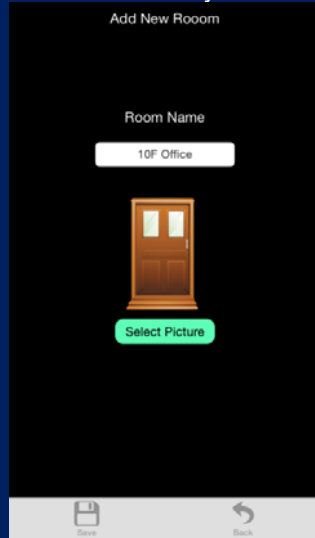

b. Click "No Room" to show the device. And place the new device in a room.

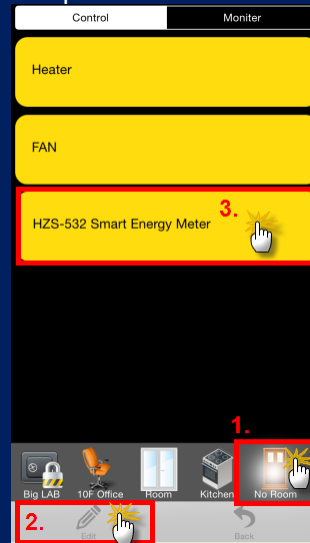

c. Select "Name" to name this device and select "Location" to place this device in the room that you created.

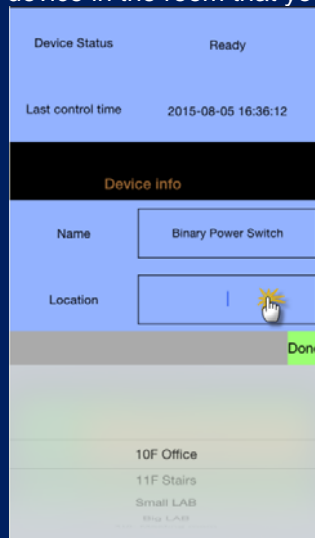

d. Select Picture for your Z-Wave device.

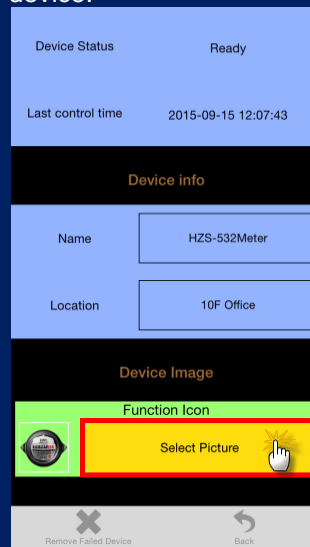

e. Click "Back" to save.



f. Done successfully.

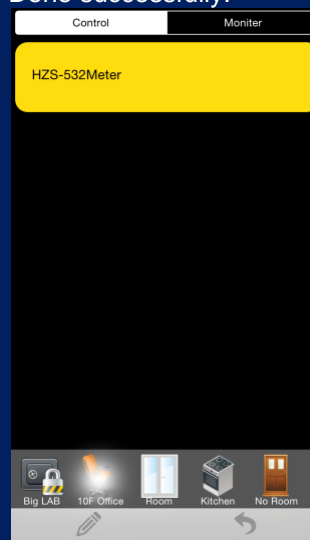

Step 3. Create a scene via smart phone.

a. Click "Add" and name a new scene.



b. Click "Add" to add a Z-Wave device.



c. Select a Z-Wave device.

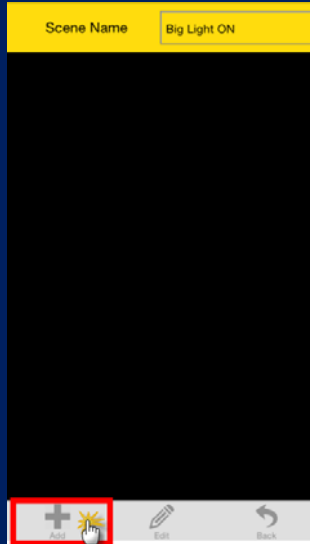

d. Click ON or OFF for the device you select.



e. Click "Back" to save.

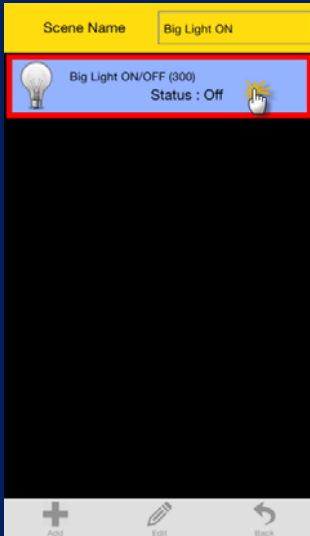

f. Done successfully.

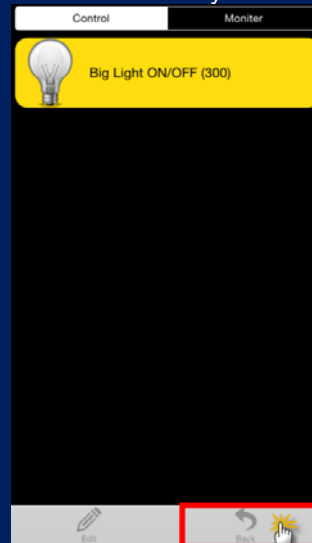

Step 4. Create Trigger via smart phone.

a. Click "Add".



b. Name this new Trigger.

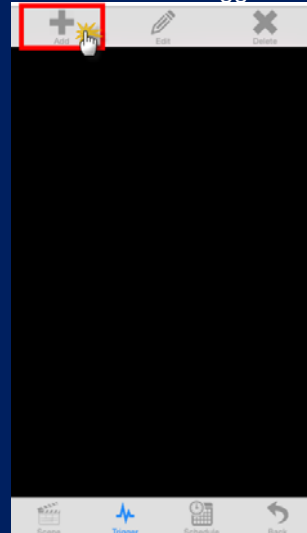

c. Select the Z-Wave device and click next.

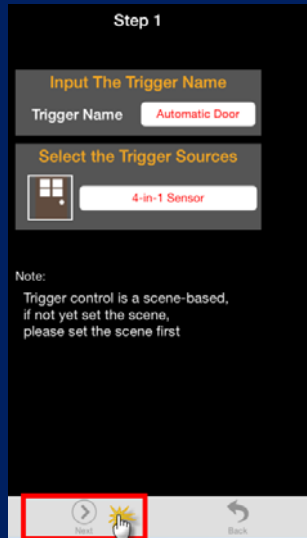

d. Select a mode for a Z-Wave device.

e. Select a scene.

f. Select the time for the trigger and which scene to run.

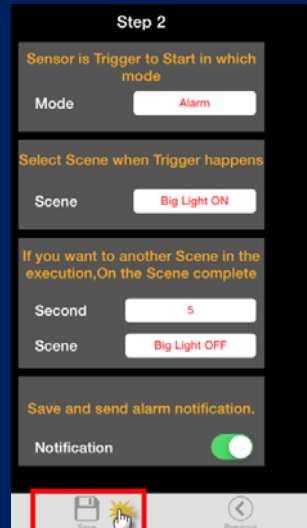

g. Done successfully.

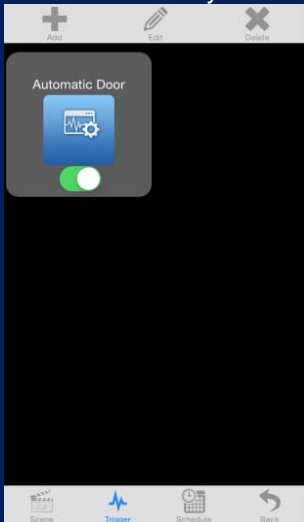

h. If you enable Save and send alarm notification, when it triggers, it will have a log. You can check this in Notification History.

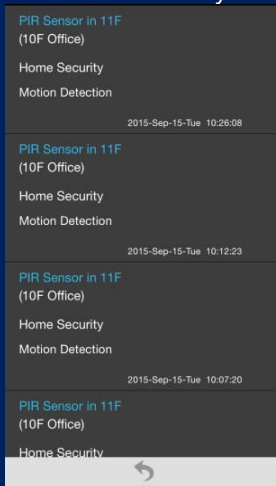

3.3 Configuring Z-Wave via HTS-1000P

Step 1. Fill out the IP of control gateway to connect with gateway.

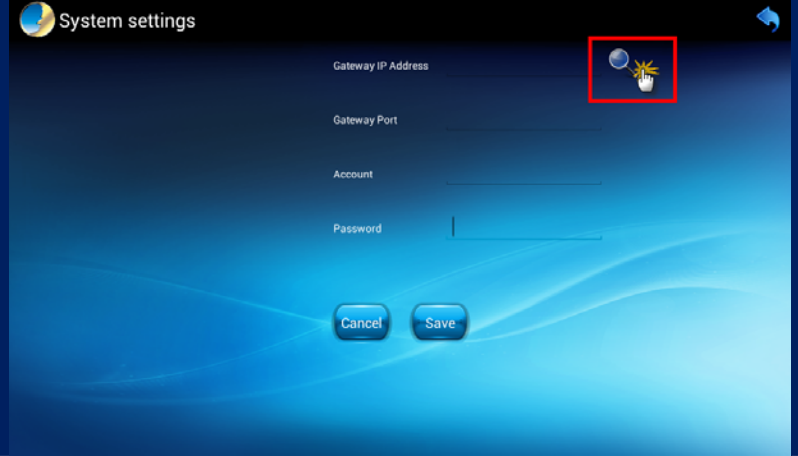
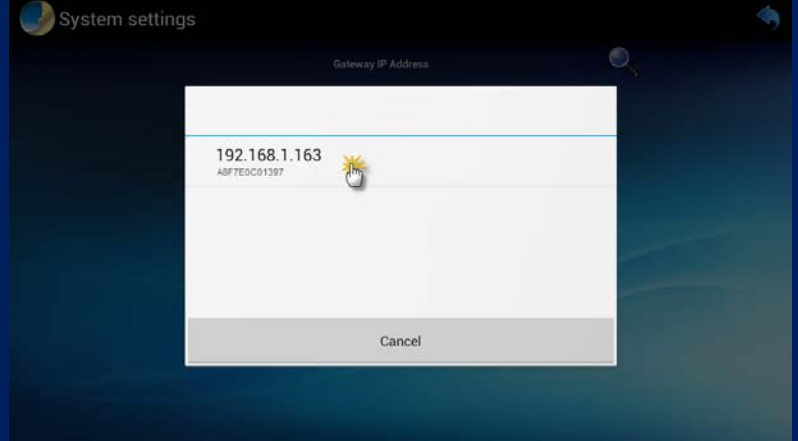
<p>Click the "Gateway" button.</p>	 <p>The screenshot shows the 'Configuration' screen with several menu items: Gateway, Control Panel, Intercom, Z-Wave devices, Scene, Upgrading, Janitor, IP Cameras, Triggers, Activate Code, and Location Setting. The 'Gateway' button is highlighted with a red rectangular box.</p>
<p>Click the magnifying glass to search the IP of gateway.</p>	 <p>The screenshot shows the 'System settings' screen with fields for Gateway IP Address, Gateway Port, Account, and Password. A magnifying glass icon is highlighted with a red rectangular box.</p>
<p>Control pad found an IP of gateway. Click the IP to join.</p>	 <p>The screenshot shows the 'System settings' screen with a search result for IP address 192.168.1.163 highlighted by a red rectangular box. Below the IP address is the MAC address ABF7E0C01397 and a magnifying glass icon.</p>

The default gateway port is 5000, and user name and password are both **admin**.

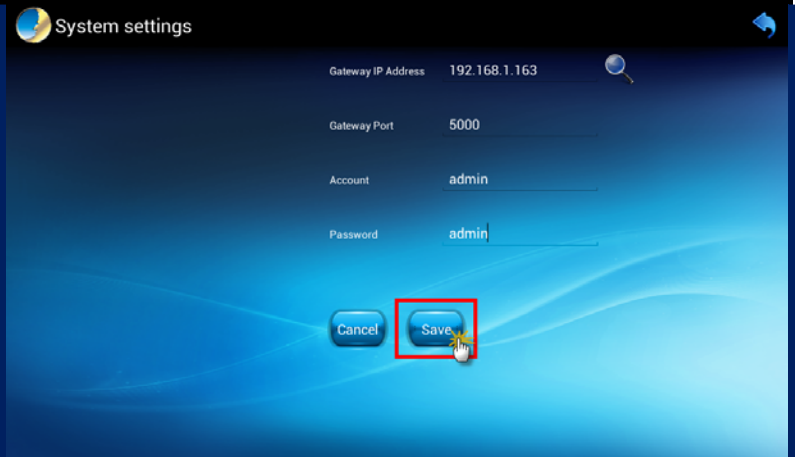

Step 2. Include a Z-Wave device via HTS-1000P.

Click the “Z-Wave devices” button to add Z-Wave devices to gateway.



Click the “Include New Device” button to add Z-Wave device.

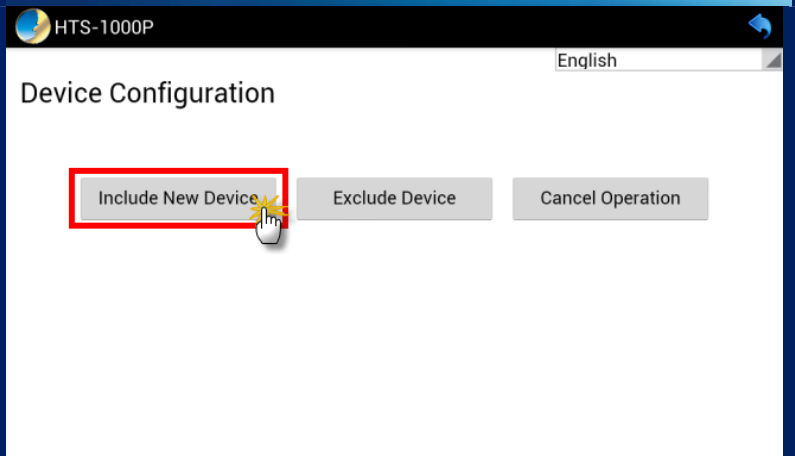

When you see the message "Waiting for user action", you can press the match button on Z-Wave devices.

The distance between HZS-200 and HAC-1000 is suggested to be in one meter. Press the program switch of the HZS-200 at least for 1 second to be included.

If a device is added successfully, it will show the message: Command has completed successfully in device No. XX.

Click the "Exclude Device" button to exclude Z-Wave device.

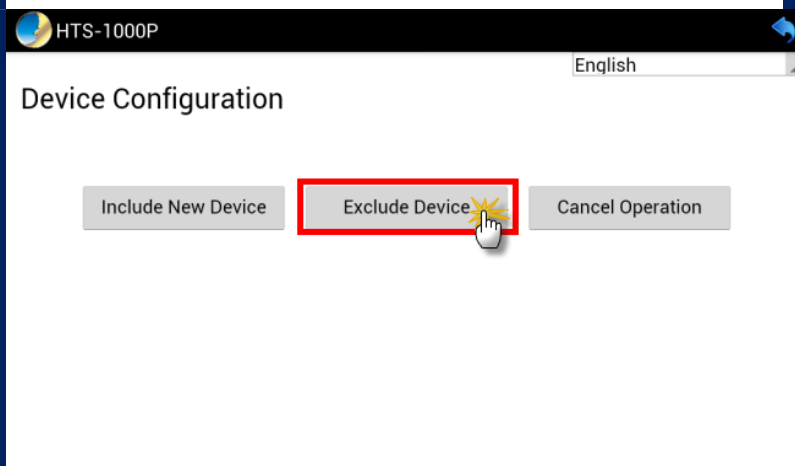
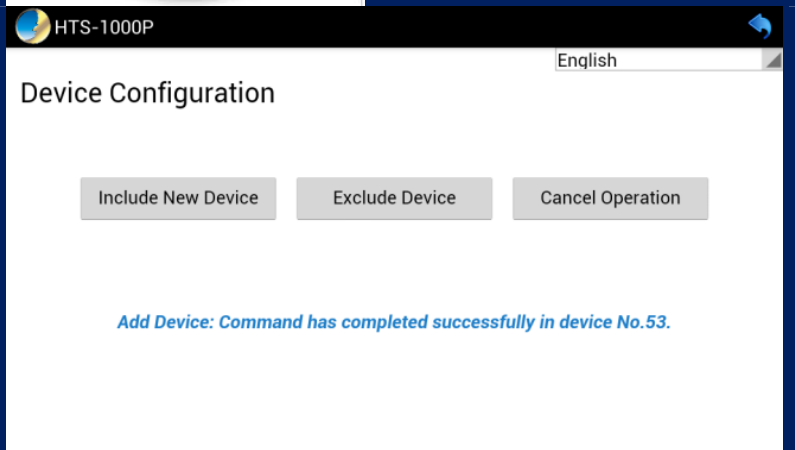
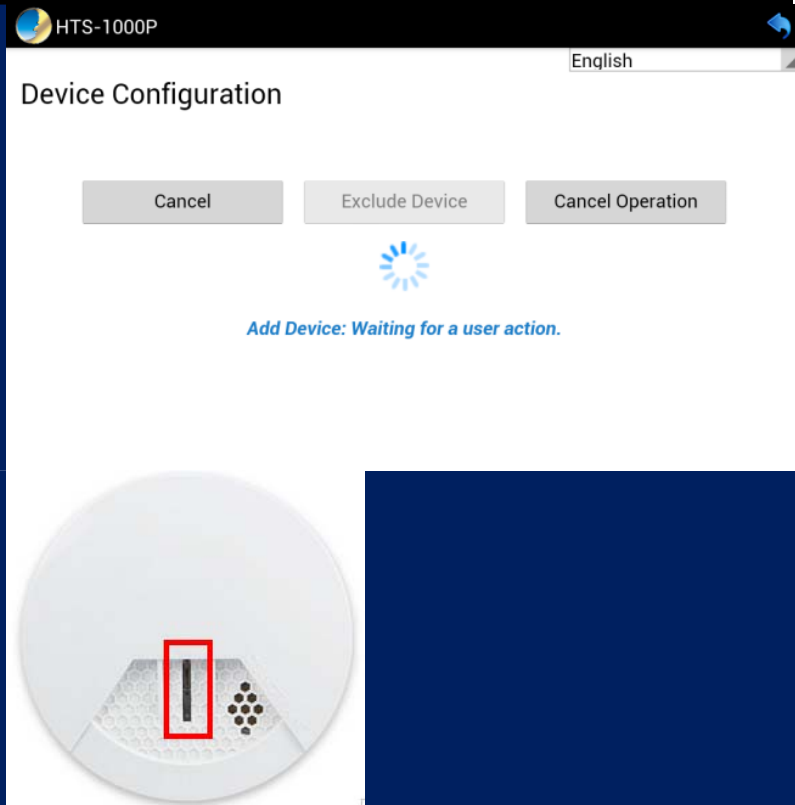

When you see the message "Waiting for user action", you can press the match button on Z-Wave devices to exclude device.

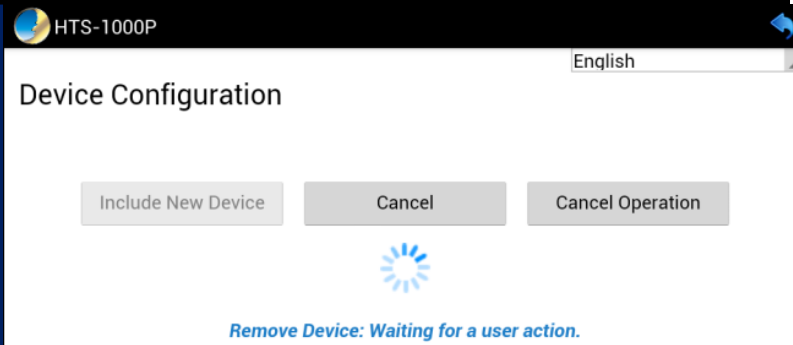

Step 3. After including Z-Wave devices in gateway, you can create different scenes with this function. You can set scenes to control your devices in **Scene** mode.

Click the "Scene" button.

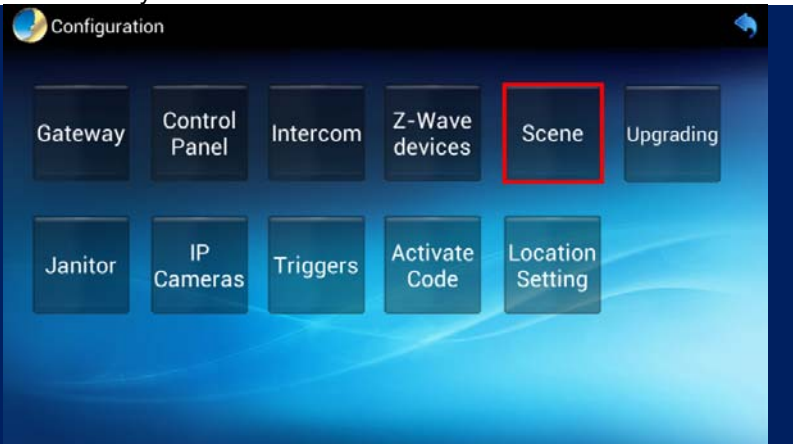

Click "Create Scene" and name the new scene.

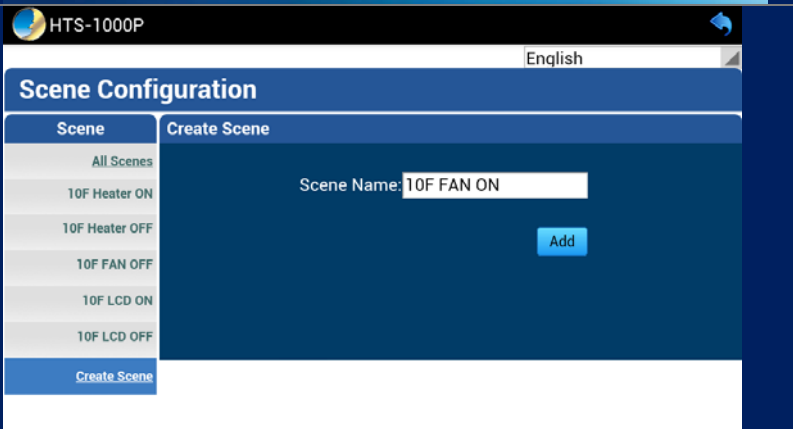

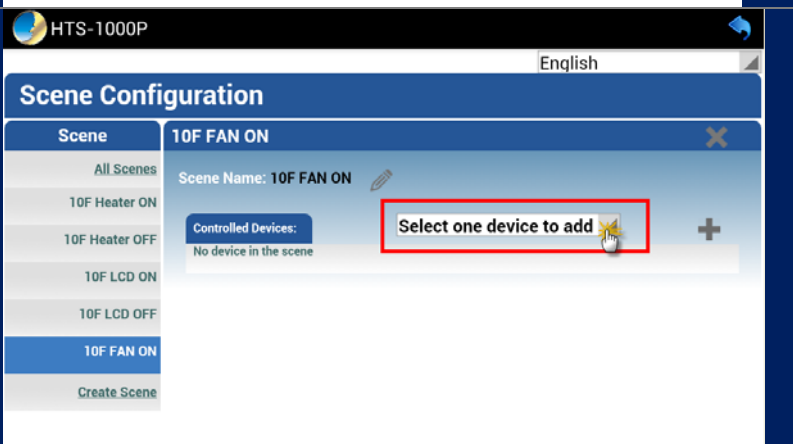

Select one device to add to the device list.



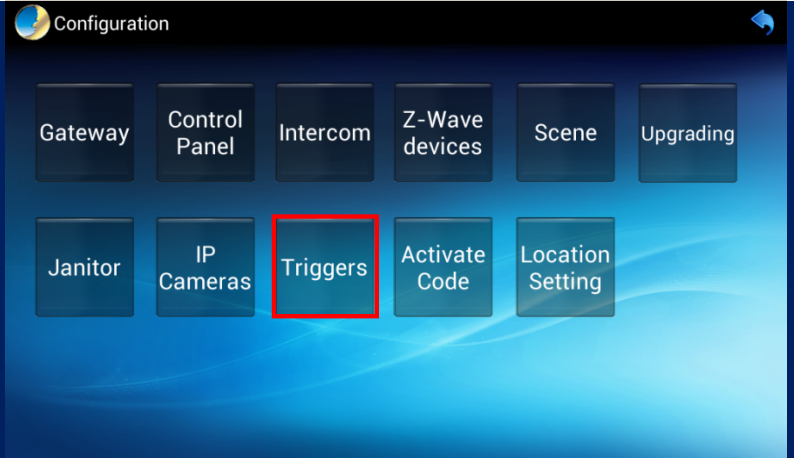
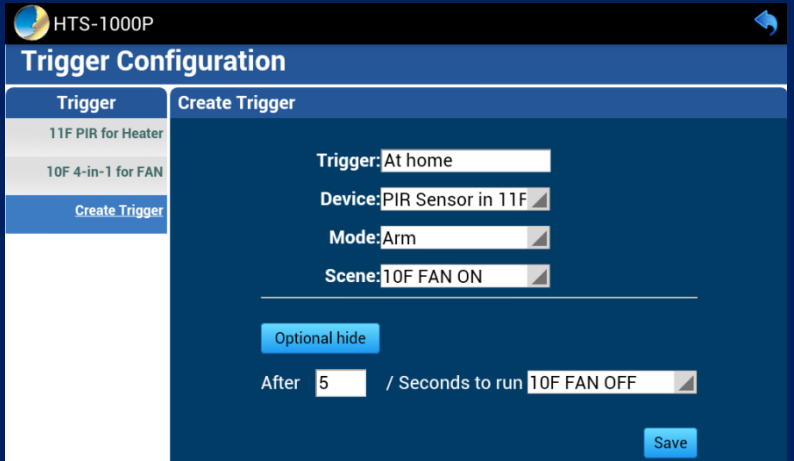
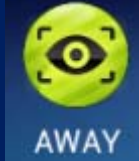

<p>Select one device.</p>	
<p>Click the "Plus" button to add device.</p>	
<p>Select the status of device (ON or OFF).</p>	
<p>Click "All Scenes" to check the scene.</p>	

Step 4. In Trigger mode, the trigger time is set. An alarm notification is sent via sensor. If a sensor is not installed, this step can be skipped.

<p>Click the "Trigger" button.</p>	
<p>Click "Create Trigger". Trigger: Name this trigger. Device: Select a Z-Wave device. Mode: Select "Arm" to enable alarm. Scene: When it triggers, the fan will turn on. Optional: After triggering for 5 seconds, the fan will turn off by itself.</p>	
<p>Switch to "AWAY" to enable monitor mode.</p>	
<p>When one of Z-Wave devices is triggered, control pad will alarm.</p>	

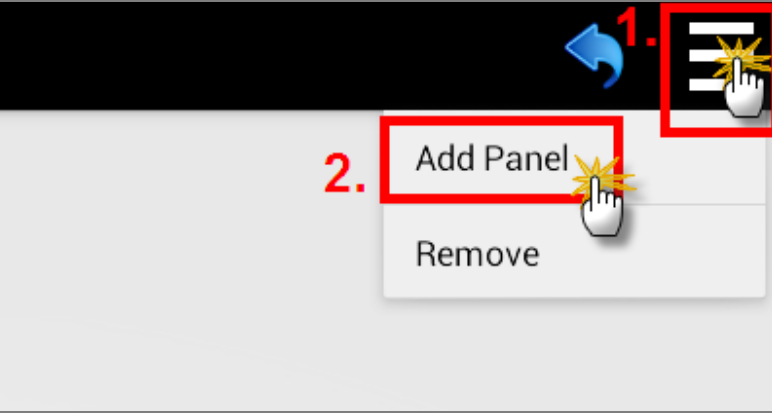
Step 5. After configuring this part, you can control Z-Wave devices and scenes via control pad.

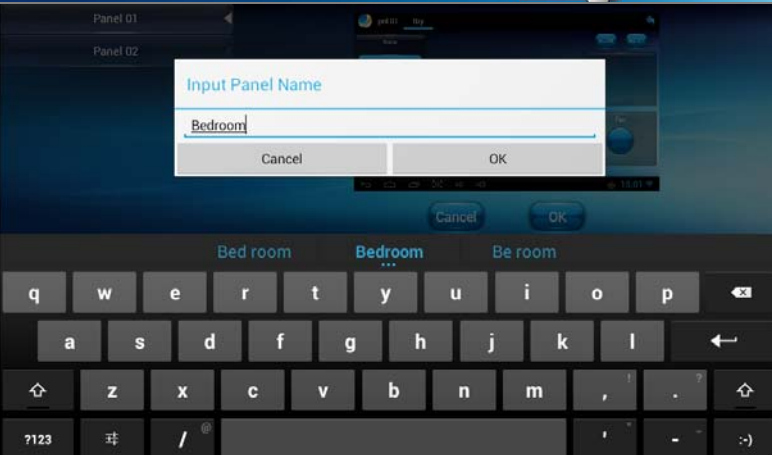
<p>Click the "Control Panel" button.</p>	
<p>Click the three-line button on the upper right corner and click "Add Panel".</p>	
<p>There are two types of panel that you can choose from.</p>	
<p>Name the panel.</p>	

Click and hold for two seconds to select the device or scene.



Click on the Device field.

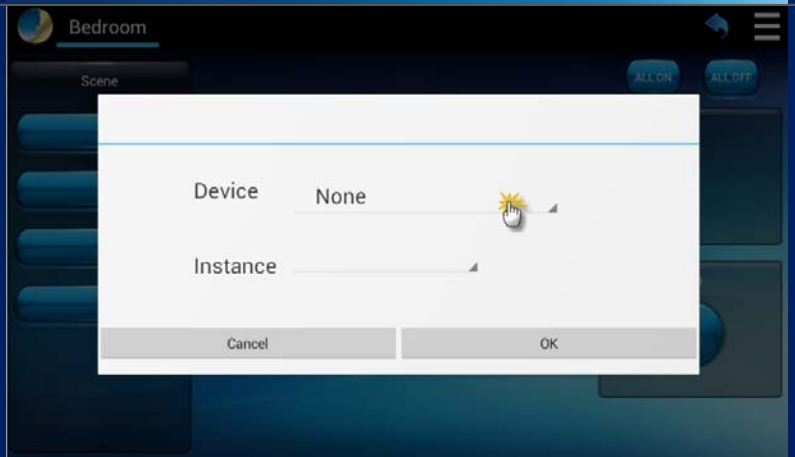

Use a paper clip or pin to press the program button on the back of the sensor for 1 time to connect.



Go back to the main page and click the "Control" button.

The dashboard features a blue background with a sun icon. It displays the day 'Thursday', date '2015/09/17', and temperature '11 °C'. A large digital clock shows '07:24'. Weather details include 'Visibility: 9.99', 'Humidity: 88%', and 'Pressure: 982.05 mb'. A status indicator 'AT HOME' is in the top right. A row of control buttons includes 'Janitor' (shield icon), 'Intercom' (phone icon), 'Camera' (eye icon), 'Contacts' (people icon), 'Control' (sliders icon, highlighted with a red box), and 'Settings' (gear icon).

You can control scenes and devices here.

The interface shows two tabs: 'Bedroom' (selected) and 'Kitchen'. Under 'Bedroom', there is a 'Scene' section with buttons for '10F FAN ON' and '10F FAN OFF'. To the right, there are four vertical sliders for 'LCD', 'Heater', and two unlabeled sliders, each with an 'OFF' button and a '0%' indicator. On the far right, there are 'ALL ON' and 'ALL OFF' buttons, a large temperature display showing '24.04°C', and a 'Fan' control with a circular button.

Appendix A: Troubleshooting & Frequently Asked Questions

Features	
This difference between Z-Wave and ZigBee	<ul style="list-style-type: none"> The frequency is different between Z-Wave and ZigBee. ZigBee is 2.4GHz and Z-Wave is about 900MHz. The outdoor distance is different. ZigBee is 10~75 meters and Z-Wave is about 30 meters.
Z-Wave Device Installation	
How to reset the HZS-200 Series	HZS-200 will reset back to default value while excluding from the network.
Repeater Function	<p>Only HZS-530 Series can extend the frequency range of Z-Wave.</p> <p>HZS-530 Series can act as a signal repeater to enhance the Z-Wave wireless communication range. For example, the HAC-1000 (Control gateway) is installed on the second floor to control over the HZS-300 (4-in-1 Sensor) on the first floor, but the Z-Wave frequency is weak. Thus, HZS-530 Series can be installed in between the second floor and the first floor to solve the problem.</p>