

# Industrial VPN Security Gateway



## Powerful Industrial VPN Security Solution with Fiber and PoE+ Capability

PLANET IVR-300, IVR-300W and IVR-300FP are Industrial VPN Security Gateways for demanding applications. The IVR-300 and IVR-300W feature five Ethernet ports (3 LANs, 1 WAN/LAN and 1 WAN) while the IVR-300FP features five Ethernet ports (4 PoE LANs and 1 WAN/LAN), one **Fiber port** (WAN/LAN). They all feature **serial port** (RS485), and DI and DO interfaces. Incorporating **SD-WAN** function, they can greatly increase WAN optimization for multiple WAN links to be managed. Furthermore, their Dual-WAN Failover and Outbound Load Balance features can improve the network efficiency while the web-based interface provides friendly and user experience.

They are ideal for the harsh environment as they can operate stably at temperatures from **-40 to 75 degrees C**. Their compact IP30 metal cases allow either DIN-rail or wall mounting for efficient use of cabinet space.



## Wireless 11ax Brings Excellent Data Link Speed (IVR-300W Only)

The IVR-300W is designed with high power amplifier and 2 highly-sensitive antennas which provide stronger signal and excellent coverage even in the wide-ranging or bad environment. With adjustable transmit power option, the administrator can flexibly reduce or increase the output power for various environments, thus reducing interference to achieve maximum performance. Equipped with the next-generation Wi-Fi 6 (802.11ax) wireless network standard, the total bandwidth reaches 1800Mbps, and the 2-stream transmission technology improves the transmission efficiency of multiple devices, making AR/VR/IoT applications smoother. The IEEE 802.11ax also optimizes MU-MIMO (Multi-User MIMO) mechanism to serve multiple devices simultaneously.

## Highlights

- Dual-WAN failover and Dual-WAN load balancing
- Complies with IEEE 802.11ax and IEEE 802.11a/b/g/n/ac standards (IVR-300W)
- One 1000BASE-X **SFP slot** for WAN/LAN interface (IVR-300FP)
- Compliant with the **IEEE 802.3at** PoE+ with PD alive check/schedule management (IVR-300FP)
- 1 USB 3.0 port for system configuration backup and firmware upgrade
- 2 x DI/DO and 1 serial port (RS485) for Modbus applications
- SSL VPN and robust hybrid VPN (IPSec/PPTP/L2TP over IPSec)
- Stateful packet inspection (SPI) firewall and content filtering
- Blocks DoS/DDoS attack, port range forwarding
- High Availability, AP Controller, Captive Portal and RADIUS
- Planet NMS controller system and CloudViewer app supported
- -40 to 75 degrees C operating temperature; DIN-rail and fanless designs

## Hardware

- 4 x 10/100/1000BASE-T RJ45 LAN port, auto-negotiation, auto MDI/MDI-X (IVR-300/IVR-300W)
- 1 x 10/100/1000BASE-T RJ45 WAN/LAN port, auto-negotiation, auto MDI/MDI-X
- 4 x 10/100/1000BASE-T RJ45 LAN ports with 4-port IEEE 802.3at PoE+ injector function (IVR-300FP)
- 1 x 1000BASE-X SFP interface WAN/LAN port (IVR-300FP)
- 1 x 3-pin terminal block (RS485)
- 1 x reset button
- 1 x USB 3.0 port

## RF Interface Characteristics (IVR-300W)

- Features 2.4GHz (802.11b/g/n/ax) and 5GHz (802.11a/n/ac/ax) dual band for carrying high load traffic
- 2T2R MIMO technology for enhanced throughput and coverage
- Provides multiple adjustable transmit power control
- High speed up to 1.8Gbps (600Mbps for 2.4GHz or 1200Mbps for 5GHz) wireless data rate

## Power over Ethernet (IVR-300FP)

- Complies with IEEE 802.3at Power over Ethernet Plus, end-span PSE

**Flexible WAN interface Enables Extension of Network Deployment (IVR-300FP Only)**

The IVR-300FP provides both copper and fiber connectors for WAN interface. With one SFP slot, it supports fiber extension for FTTX application. It allows the administrator to flexibly choose the suitable SFP transceiver according to the transmission distance required to extend the network efficiently. The distance can be extended from 550 meters to 2 kilometers (multi-mode fiber) and 10/20/30/40/50/60/70/120 kilometers (single-mode fiber or WDM fiber). They are well suited for applications to uplink to backbone switch and monitoring center in long distance.

**Intelligent SFP Diagnosis Mechanism (IVR-300FP Only)**

The IVR-300FP supports SFP-DDM (digital diagnostic monitor) function that greatly helps network administrator to easily monitor real-time parameters of the SFP, such as optical output power, optical input power, temperature, laser bias current, and transceiver supply voltage.

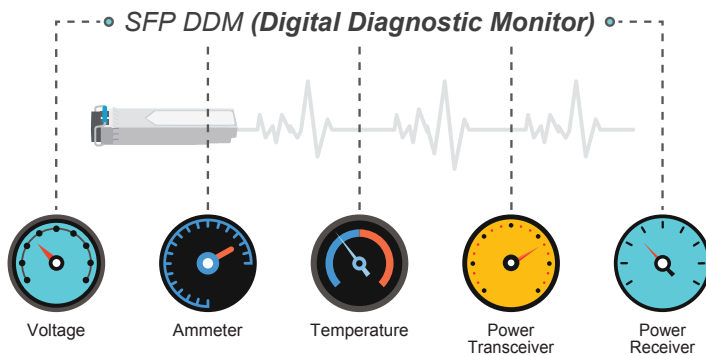

**Built-in Unique PoE Functions for Powered Devices Management (IVR-300FP Only)**

The IVR-300FP is capable of having a maximum of up to 120 watts of power output and can deliver up to 36W for each port. It also features the following special PoE management functions.

**PoE Usage Monitoring (IVR-300FP Only)**

With PoE usage monitoring, it can show the PoE loading of each port, total PoE power usage and system status, such as overload, low voltage, over voltage and high temperature. User can obtain detailed information about the real-time PoE working condition of the IVR-300FP directly.

**PoE Schedule (IVR-300FP Only)**

Under the trend of energy saving worldwide and contributing to environmental protection, the IVR-300FP can effectively control the power supply besides its capability of giving high watts power. The “PoE schedule” function helps you to enable or disable PoE power feeding for each PoE port during specified time intervals and it is a powerful function to help SMBs or enterprises save power and budget. It also increases security by powering off PDs that should not be in use during non-business hours.

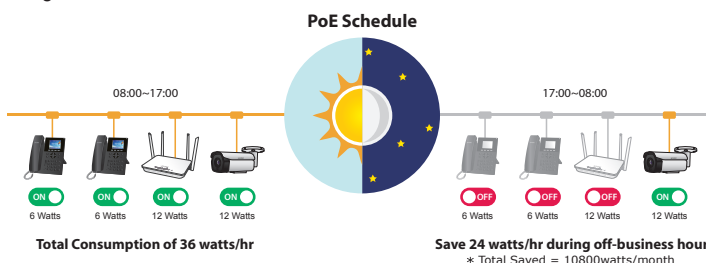

- Backward compatible with IEEE 802.3af Power over Ethernet
- Up to 4 ports of IEEE 802.3af / 802.3at devices powered
- Supports PoE power up to 36 watts for each PoE port
- Auto detects powered device (PD)
- Circuit protection prevents power interference between ports
- PoE management
  - Total PoE power budget control
  - Per port PoE function enable/disable
  - PoE port power feeding priority
  - Per PoE port power limitation
  - PD classification detection
  - PD alive check

**IP Routing Feature**

- Static Route
- Dynamic Route
- OSPF

**Firewall Security**

- Cybersecurity
- Stateful Packet Inspection (SPI) firewall
- Blocks DoS/DDoS attack
- Content Filtering
- MAC Filtering and IP Filtering
- NAT ALGs (Application Layer Gateway)
- Blocks SYN/ICMP Flooding

**VPN Features**

- IPSec/Remote Server (Net-to-Net, Host-to-Net), GRE, PPTP Server, L2TP Server, SSL Server/Client (Open VPN)
- Max. Connection Tunnel Entries: 60 VPN tunnels,
- Encryption methods: DES, 3DES, AES, AES-128/192/256
- Authentication methods: MD5, SHA-1, SHA-256, SHA-384, SHA-512

**Networking**

- Outbound load balancing for Ethernet WANs
- Auto-failover between Ethernet WANs network
- High Availability
- Captive Portal
- RADIUS Server
- Static IP/PPPoE/DHCP client for WAN
- DHCP server/NTP client for LAN
- Protocols: TCP/IP, UDP, ARP, IPv4, IPv6
- Port forwarding, QoS, DMZ, IGMP, UPnP, SNMPv1, v2c, v3
- MAC address clone
- DDNS: PLANET DDNS, Easy DDNS, DynDNS and No-IP

**Scheduled Power Recycling (IVR-300FP Only)**

The IVR-300FP allows each of the connected PoE IP cameras or PoE wireless access points to reboot at a specific time each week. Therefore, it will reduce the chance of IP camera or AP crash resulting from buffer overflow.

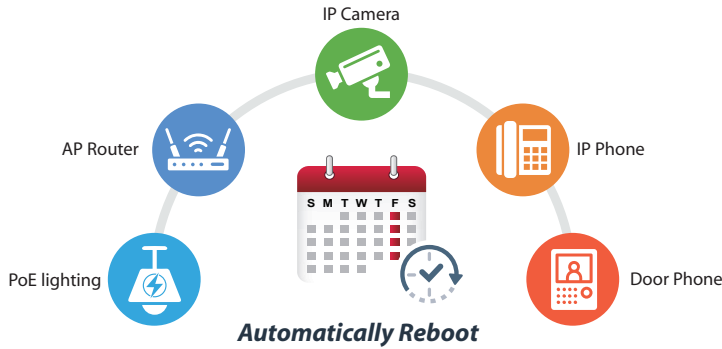

**Others**

- Setup wizard
- Dashboard for real-time system overview
- Support for HTTP or HTTPS
- Auto reboot
- PLANET NMS System and Smart Discovery Utility for deployment management
- PLANET CloudViewer app for real-time monitoring
- Configuration backup and restoration via remote/USB port
- Firmware upgrade via remote/USB port

**PD Alive Check (IVR-300FP Only)**

The IVR-300FP can be configured to monitor connected PD status in real time via ping action. Once the PD stops working and responding, the IVR-300FP will resume the PoE port power and bring the PD back to work. It will greatly enhance the network reliability through the PoE port resetting the PD's power source and reducing administrator management burden.

## PD Alive Check

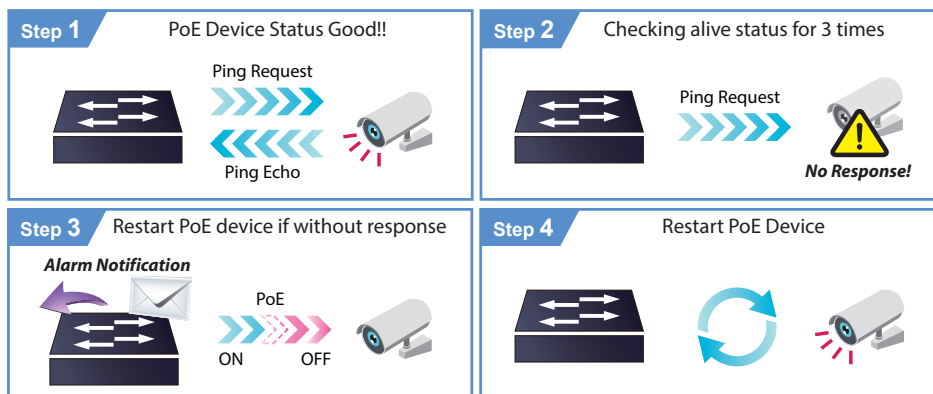

**Ideal VPN Security Gateway Solution for Factories and Transportations**

The IVR-300 series provides complete data security and privacy for accessing and exchanging the most sensitive data, built-in IPSec VPN function with DES/3DES/AES encryption and MD5/SHA-1/SHA-256/SHA-384/SHA-512 authentication, and GRE, SSL, PPTP and L2TP server mechanism. The full VPN capability in the IVR-300FP makes the connection secure, more flexible, and more capable.

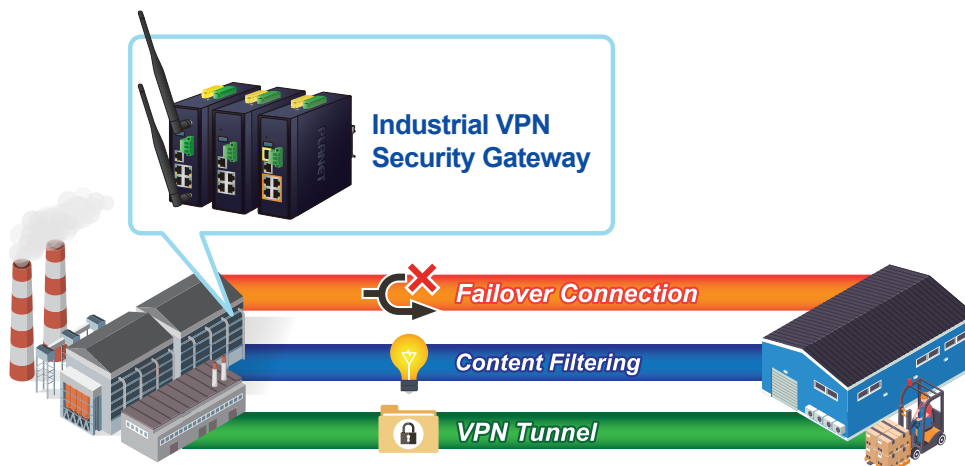

**Centralized Remote Control of Managed APs**

The IVR-300 series provides centralized management of PLANET Smart AP series via a user-friendly Web GUI. It's easy to configure AP for the wireless SSID, radio band and security settings. With a four-step configuration process, wireless profiles for different purposes can be simultaneously delivered to multiple APs or AP groups to minimize deployment time, effort and cost.

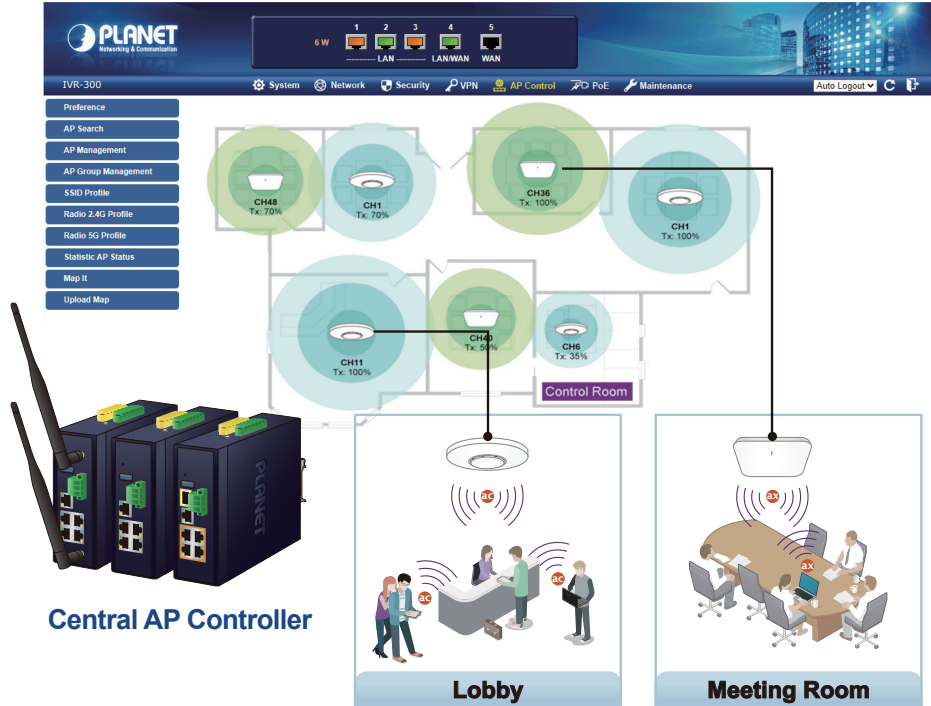

For example, to configure multiple smart APs of the same model, the IVR-300 series allows clustering them to a managed group for unified management. According to requirements, wireless APs can be flexibly expanded or removed from a wireless AP group at any time. The AP cluster benefits bulk provision and bulk firmware upgrade through single entry point instead of having to configure settings in each of them separately.

**Simplified Cluster Management with 4 Steps**

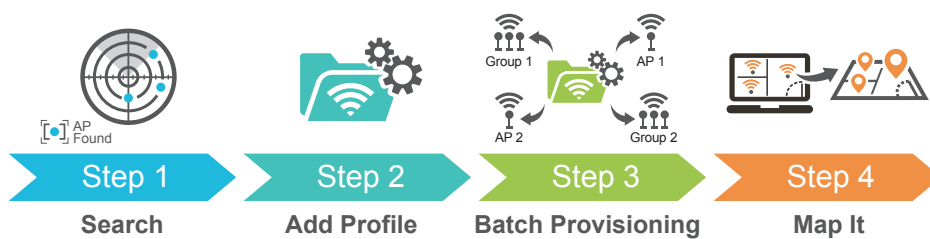

**Wi-Fi Deployments and Authentication with Simplified Management**

The IVR-300 series also provides a built-in AP Controller, Captive Portal, RADIUS and a DHCP server to facilitate small and medium businesses to deploy secure employee and guest access services without any additional server. The IVR-300 series can offer a secure Wi-Fi network with easy installation for your business.

**Captive Portal**



**Excellent Ability in Threat Defense**

The IVR-300 series has built-in SPI (stateful packet inspection) firewall and DoS/DDoS attack mitigation functions to provide high efficiency and extensive protection for your network. Thus, virtual server and DMZ functions can let you set up servers in the Intranet and still provide services to the Internet users.

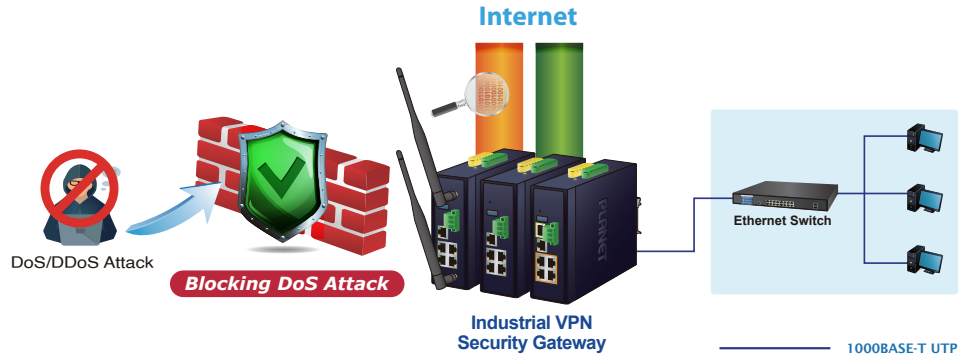

**Cybersecurity Network Solution to Minimize Security Risks**

The cybersecurity feature included to protect the switch management in a mission-critical network virtually needs no effort and cost to install. For efficient management, the IVR-300 series is equipped with HTTPS web and SNMP management interfaces. With the built-in web-based management interface, the IVR-300 series offers an easy-to-use, platform independent management and configuration facility. The IVR-300FP supports SNMP and it can be managed via any management software based on the standard SNMP protocol.

**Maximizing Work Efficiency with PLANET SD-WAN Gateway**

PLANET IVR-300 series incorporated in SD-WAN (software-defined wide area network) function can greatly increase WAN optimization for multiple WAN links to be managed. With SD-WAN, users can connect any application across all available network connections at every site. It improves application performance and provides a high-quality user experience for increasing business productivity and reducing IT costs.

**Cost-effective Solution for RS485 to Ethernet Application**

The IVR-300 series provides a feature that can convert the Serial RS485 communication to IP networking. Ethernet signal allows two types of segments to connect easily, efficiently and inexpensively. The solution helps users and SIs save expenses as there is no need to replace the existing serial equipment and software system.

**Convert Serial Communication to IP Networking**

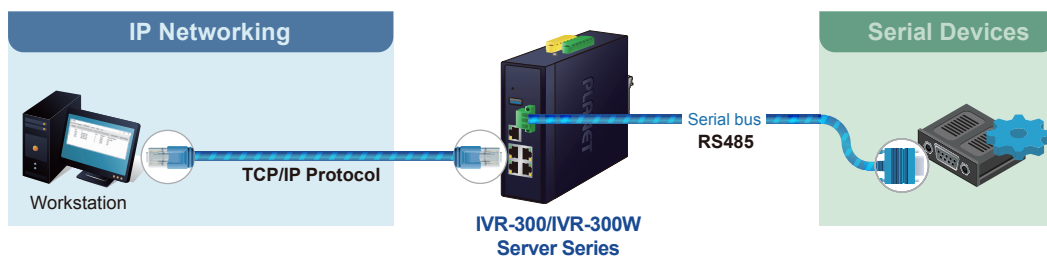

**Convenient and Reliable Redundant Power System**

To facilitate transportation and industrial-level applications, the IVR-300/IVR-300W provide an integrated power solution with a wide range of voltages (9~54V DC) for worldwide operability. The IVR-300FP provides an integrated power solution with 48~54V DC voltages for worldwide operability. It also provides dual-redundant, reversible polarity DC power supply inputs for high availability applications.

## Applications

### Ideal VPN Security Gateway

PLANET IVR-300 series can work as a VPN security gateway in an industrial application for a company that has a factory and many different divisions. With IPSec/GRE/PPTP/L2TP/SSL VPN solutions, the IVR-300 series installed at the headquarters provides branches, vendors, and mobile workers with secure data communication no matter how long the distance would be.

The IVR-300 series connects dual WANs with up to two different ISPs. It creates a stable and qualified VPN connection for many important applications such as VoIP, video conferencing and data transmission. (The figure below takes IVR-300FP as an example).

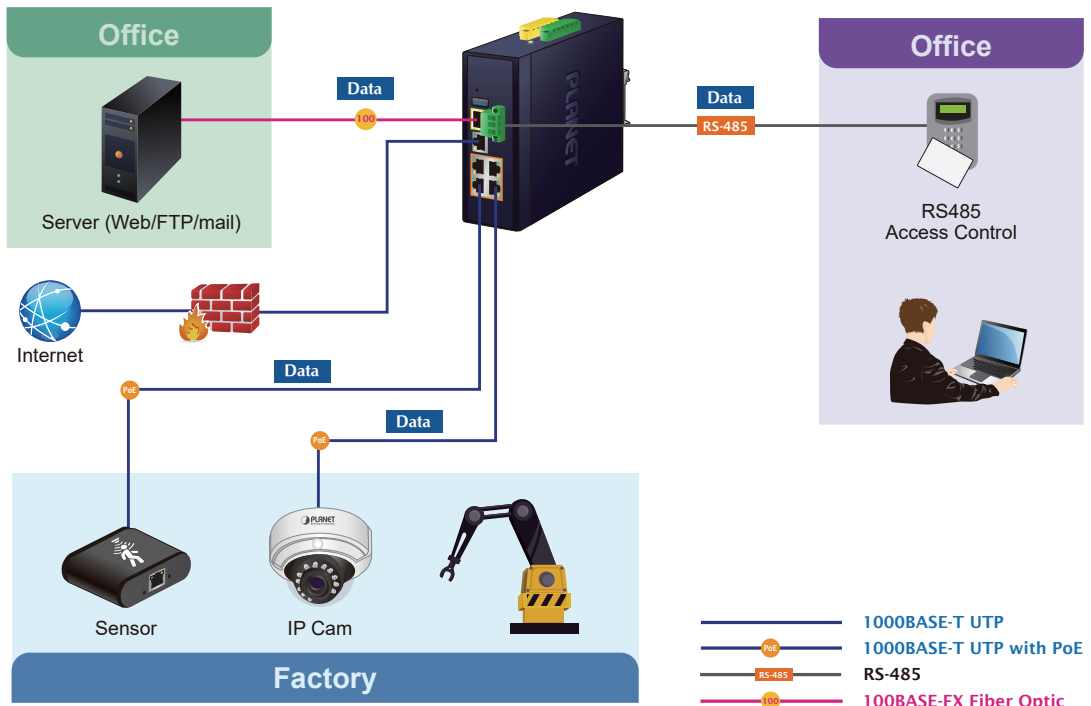

## Specifications

Product	IVR-300	IVR-300W	IVR-300FP
<b>Hardware Specifications</b>			
Copper Ports	5 10/100/1000BASE-T RJ45 Ethernet ports including <ul style="list-style-type: none"> <li>• 3 LAN ports (Ports 1 to 3)</li> <li>• 1 LAN/WAN port (Port 4)</li> <li>• 1 WAN port (Port 5)</li> </ul>		5 10/100/1000BASE-T RJ45 Ethernet ports including <ul style="list-style-type: none"> <li>• 4 LAN ports (Ports 1 to 4)</li> <li>• 1 WAN/LAN port (Port 5)</li> </ul>
Fiber Port	-		1 1000BASE-X SFP slot including <ul style="list-style-type: none"> <li>• 1 WAN/LAN port (Port 6)</li> </ul>
Serial Interface	1 x 3-pin terminal block for RS485		
USB Port	1 USB 3.0 port		
DI & DO Interfaces	2 Digital Input (DI): Level 0: -24V~2.1V (±0.1V) Level 1: 2.1V~24V (±0.1V) Input Load to 24V DC, 10mA max. 2 Digital Output (DO): Open collector to 24V DC, 100mA max.		
Connector	Removable 6-pin terminal block for power input Pin 1/2 for Power 1, Pin 3/4 for fault alarm, Pin 5/6 for Power 2		
Reset Button	< 5 sec: System reboot > 5 sec: Factory default		
Enclosure	IP30 metal case		
Installation	DIN-rail, desktop, wall-mounting		
LED Indicators	System: P1 (Green) P2 (Green) Alarm (Red) I/O (Red) Per 10/100/1000 RJ45 Ports (Ports 1-4 and WAN Port): 1000 LNK/ACT (Green) 10/100 LNK/ACT (Amber)	System: P1 (Green) P2 (Green) Alarm (Red) I/O (Red) Per 10/100/1000 RJ45 Ports (Ports 1-4 and WAN Port): 1000 LNK/ACT (Green) 10/100 LNK/ACT (Amber) Wi-Fi: 2.4G (Green) 5G (Green)	System: P1 (Green) P2 (Green) Alarm (Red) I/O (Red) Per 10/100/1000 RJ45 Ports (Ports 1-4): LNK/ACT (Green) PoE-in-Use (Amber) Per 10/100/1000 RJ45 Ports (Ports 5): LNK/ACT (Green) 1000 LNK (Amber) Per 1000BASE-X SFP Interfaces (Port 6): LNK/ACT (Green)
Dimensions (W x D x H)	50 x 135 x 135 mm		
Weight	712g	773g	765g
Power Requirements – DC	9~54V DC, 1.8A		48~54V DC, 3A
Power Consumption	Max. 3.7 watts/12.61 BTU (No Loading) Max. 8.7 watts/29.66 BTU (Full loading)	Max. 3.8 watts/12.95 BTU (No Loading) Max. 15.6 watts/53.19 BTU (Full loading)	Max. 7.56 watts/25.8 BTU (No Loading) Max. 127 watts/433.34 BTU (Full loading)
<b>Wireless (IVR-300W Only)</b>			
Standard	IEEE 802.11a/n/ac/ax 5GHz IEEE 802.11g/b/n/ax 2.4GHz		
Band Mode	2.4G & 5G concurrent mode		
Antenna	5 dBi external antennas with SMA connectors for Wi-Fi		
Frequency Range	2.4GHz: America FCC: 2.412~2.462GHz Europe ETSI: 2.412GHz~2.472GHz 5GHz: 5.15GHz ~5.875GHz		

Operating Channels	<p><b>2.4GHz:</b>  Non-DFS: 36, 40, 44, 48, 149,153,157,161,165  DFS: 52, 56, 60, 64, 100, 104, 108, 112, 116, 132, 136, 140</p> <p><b>5GHz:</b>  <i>America FCC:</i>  Non-DFS: 36, 40, 44, 48, 149,153,157,161,165  DFS: 52, 56, 60, 64, 100, 104, 108, 112, 116, 132, 136, 140  <i>Europe ETSI:</i>  Non-DFS: 36, 40, 44, 48  DFS: 52, 56, 60, 64, 100, 104, 108, 112, 116, 120, 124, 128, 132, 136, 140</p> <p><b>*5GHz channel list may vary in different countries according to their regulations.</b></p>
Channel Width	20MHz, 40MHz, 80MHz
Data Transmission Rates	<p>Transmit: 600 Mbps* for 2.4 GHz and 1200 Mbps* for 5 GHz  Receive: 600 Mbps* for 2.4 GHz and 1200 Mbps* for 5 GHz</p> <p><b>*The estimated transmission distance is based on the theory. The actual distance may vary in different environments.</b></p>
Transmission Power	<p>11b: 23dbm+/- 1.5dbm @11Mbps  11g: 20dbm+/- 1.5dbm @54Mbps  11g/n: 20dBm +/- 1.5dbm @MCS7, HT20  17dBm@MCS7,HT40  11a: 19.5dBm +/- 1.5dbm @54Mbps  11a/n: 19.5dBm+/- 1.5dbm @MCS7, HT20  17dBm@MCS7, HT40  11ac HT20: 20+/-1.5dBm @MCS8  11ac HT40: 17+/-1.5dBm @MCS9  11ac HT80: 14.5+/-1.5dBm @MCS9  11ax HT20: 20+/-1.5dBm @MCS9  11ax HT40: 17 +/- 1.5dBm @MCS9  11ax HT80: 14.5 +/- 1.5dBm @MCS11</p>
Encryption Security	<p>WEP (64/128-bit) encryption security  WPA / WPA2 (TKIP/AES)  WPA-PSK / WPA2-PSK (TKIP/AES) / WPA3-PSK (TKIP/AES)  802.1x Authenticator</p>
Wireless Advanced	<p>Wi-Fi Multimedia (WMM)  Auto channel selection  Wireless output power management  MAC address filtering</p>
<b>Power over Ethernet (IVR-300FP Only)</b>	
PoE Standard	IEEE 802.3af / 802.3at PoE+ PSE
PoE Power Supply Type	End-span
PoE Power Output	Per port 54V DC, 35 watts (max.)
Power Pin Assignment	1/2 (+), 3/6 (-)
PoE Power Budget	120 watts (max.)
Max. Number of Class 4 PDs	4
PoE Management	<p>PD Alive Check  Scheduled Power Recycling  PoE Schedule  PoE Usage Monitoring</p>
<b>Advanced Functions</b>	
VPN	<p>IPSec/Remote Server (Net-to-Net, Host-to-Net)  GRE  PPTP Server  L2TP Server  SSL Server/Client (Open VPN)</p>
VPN Tunnels	Max. 60
VPN Throughput	Max. 108Mbps
Encryption Methods	DES, 3DES, AES or AES-128/192/256 encrypting
Authentication Methods	MD5/SHA-1/SHA-256/SHA-384/SHA-512 authentication algorithm
<b>Management</b>	
Basic Management Interfaces	<p>Web browser  SNMP v1, v2c  PLANET Smart Discovery utility and NMS controller supported</p>



Secure Management Interfaces	TLSv1.2, SNMP v3
System Log	System Event Log
Others	Setup wizard Dashboard System status/service Statistics Connection status Auto reboot Diagnostics
<b>Standards Conformance</b>	
Regulatory Compliance	CE, FCC
<b>Standards Conformance</b>	
Operating	Temperature: -40 ~ 75 degrees C Relative humidity: 5 ~ 90% (non-condensing)
Storage	Temperature: -40 ~ 85 degrees C Relative humidity: 5 ~ 90% (non-condensing)

## Dimensions

### IVR-300

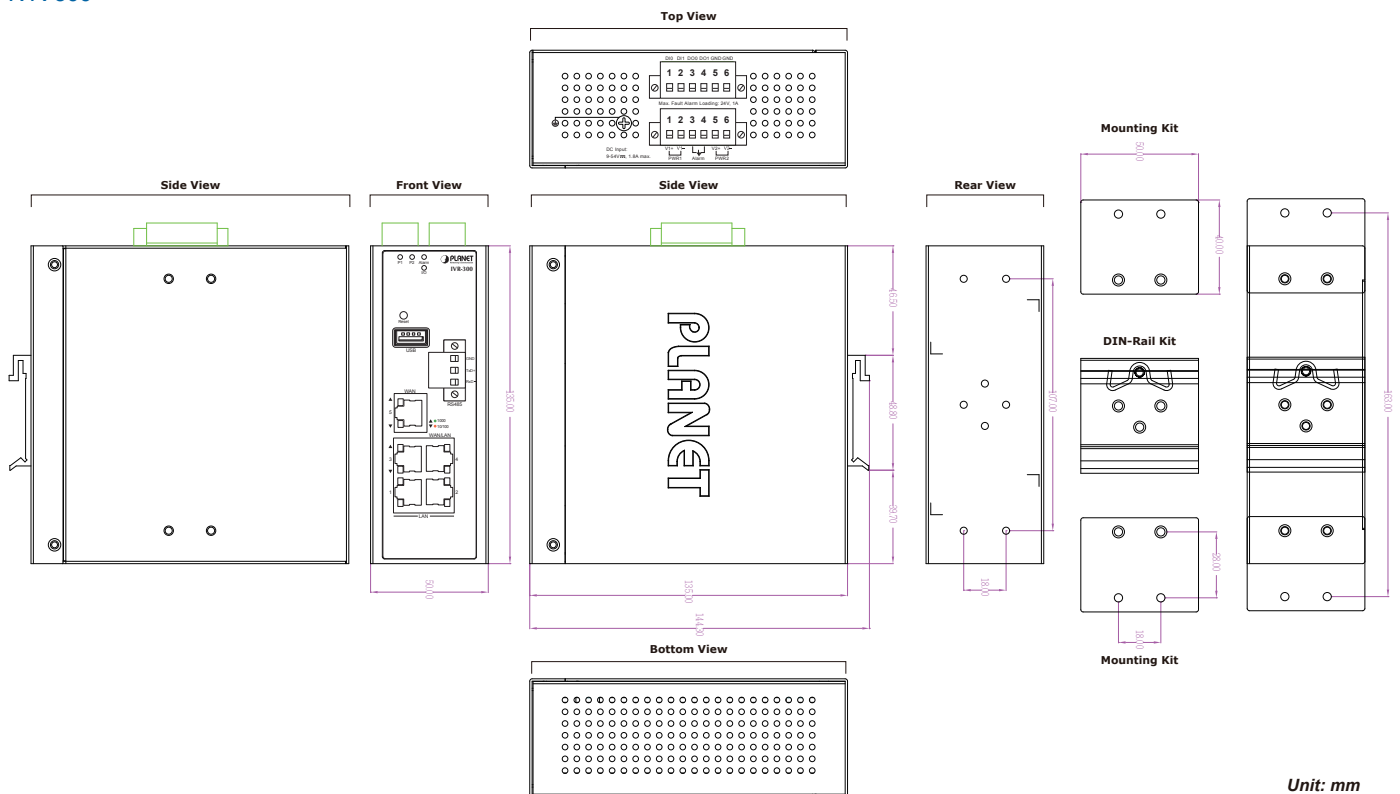

Unit: mm

IVR-300W

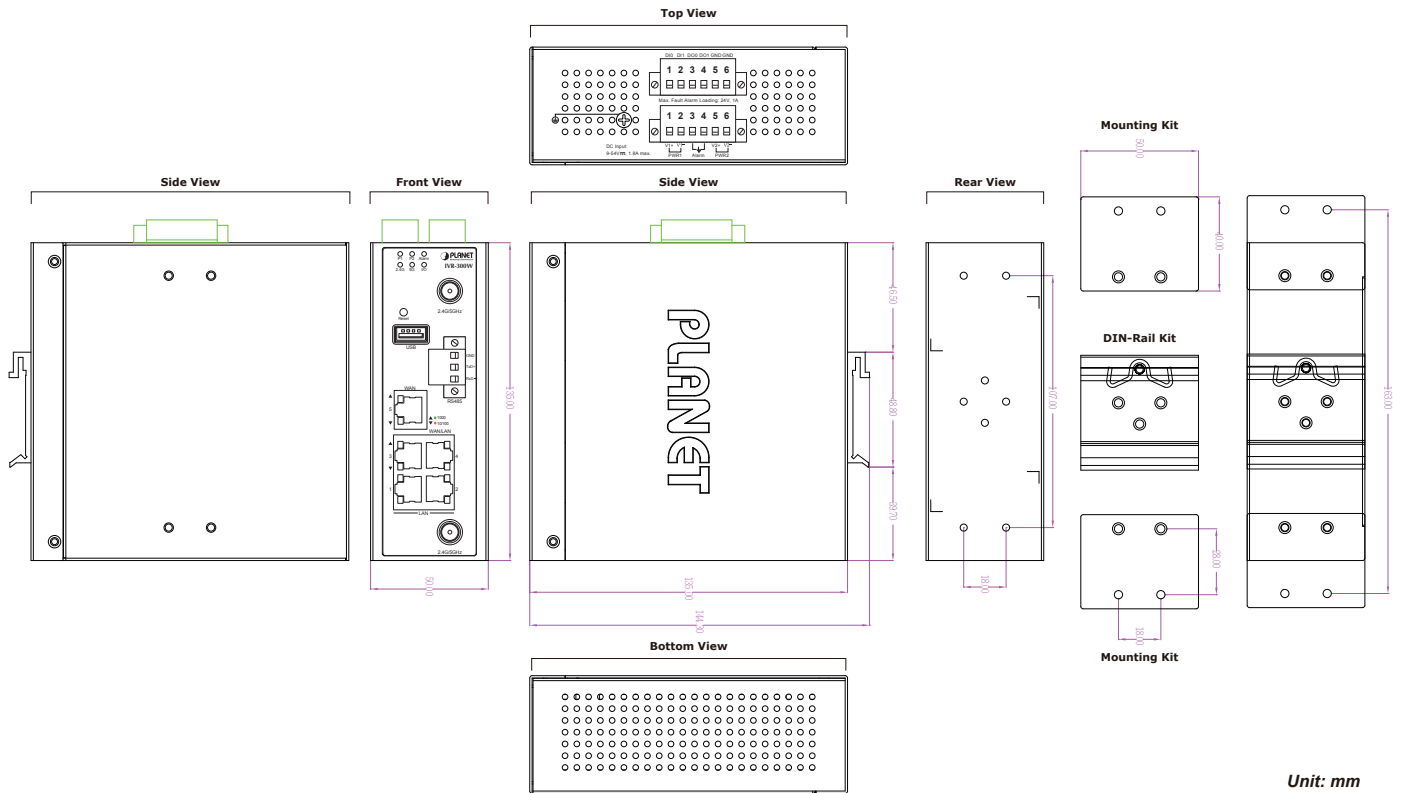

IVR-300FP

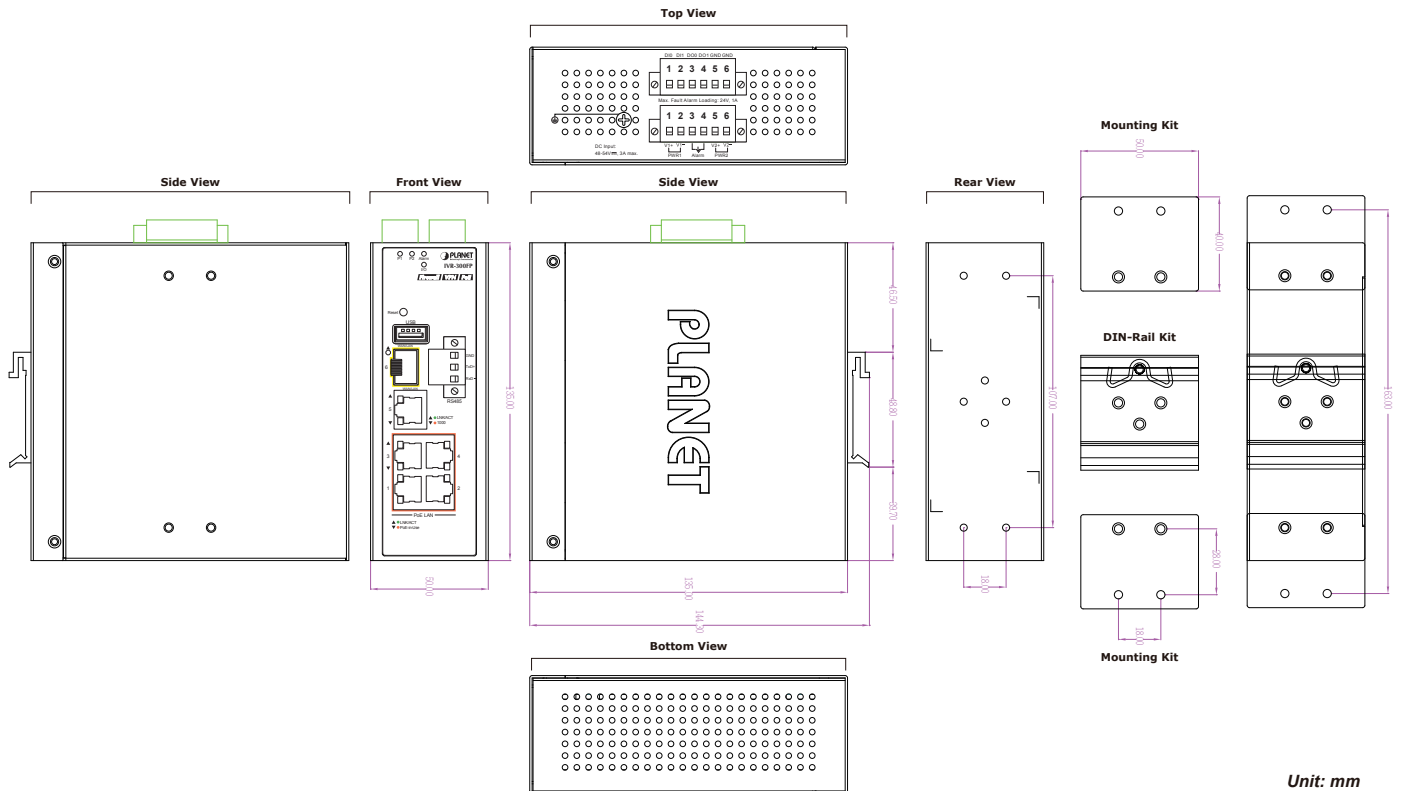

## Ordering Information

IVR-300FP	Industrial 4-Port 10/100/1000T 802.3at PoE + 1-Port 10/100/1000T + 1-Port 1000X SFP VPN Security Gateway
IVR-300W	Industrial 5-Port 10/100/1000T + 802.11ax Wi-Fi VPN Security Gateway
IVR-300	Industrial 5-Port 10/100/1000T VPN Security Gateway with Redundant Power
IVR-100	Industrial 5-Port 10/100/1000T VPN Security Gateway

## Related Products

ICG-2515FW-NR	Industrial 5G NR Cellular Wireless Gateway with 1-Port 1000X SFP
ICG-2515F-NR	Industrial 5G NR Cellular Gateway with 1-Port 1000X SFP
ICG-2515-NR	Industrial 5G NR Cellular Gateway with 5-Port 10/100/1000T
WGR-500-4PV	Industrial Wall-mount Gigabit Router with 4-Port 802.3at PoE+ and LCD Touch Screen
WGR-500-4P	Industrial Wall-mount Gigabit Router with 4-Port 802.3at PoE+
WGR-500	Industrial 5-Port 10/100/1000T Wall-mount Gigabit Router