

Industrial 4-/8-Port 10/100TX + 2-Port 1000X SFP Ring Ethernet Switch



Brand-new Solution for More Practicability and Efficiency

In response to the growing demand for IIoT (Industrial Internet of Things) infrastructures, PLANET has launched a series of Industrial Ring Ethernet Switches designed for industrial networking applications. The series is able to operate in temperatures ranging from **-40 to 75 degrees C**. The IFGS-620TF, IFGS-624PTF and IFGS-1222TF Industrial Ring Ethernet Switches are designed for easy deployment of industrial networks with their Plug and Play capability. Furthermore, the series ensures stable and reliable data and power transmission at a high speed. It also supports PROFINET traffic pass-through with QoS, making it an ideal choice for integrating with industrial automation systems and enhancing communication between devices in a factory setting. The tables below show the models and descriptions with the number of ports:

Model Name	Model Description
IFGS-620TF	Industrial 4-Port 10/100TX + 2-Port 1000X SFP Ring Ethernet Switch
IFGS-624PTF	Industrial 4-Port 10/100TX 802.3at PoE + 2-Port 1000X SFP Ring Ethernet Switch
IFGS-1222TF	Industrial 8-Port 10/100TX + 2-Port 10/100/1000T + 2-Port 1000X SFP Ring Ethernet Switch

Model Name	10/100TX Copper Ports	802.3at PoE Ports	10/100/100T Copper Ports	1000X SFP Ports
IFGS-620TF	4	-	-	2
IFGS-624PTF	4	4	-	2
IFGS-1222TF	8	-	2	2

Fast Recovery for Industrial Ethernet Transmission Applications

The Industrial Ring Ethernet Switch series supports the super-fast, fault-tolerant ring redundancy technology and features strong rapid self-recovery capability to prevent interruptions and external intrusions. Its **dual SFP ports** incorporate the advanced **ring data recovery through DIP switch** technology and **redundant power** input system into customer's industrial automation network to enhance system reliability and uptime in harsh environments. In a simple Ring network with **8 units**, the recovery time of data link can be **as fast as 1ms**.

IFGS-620TF Physical Port

- Four 10/100BASE-TX RJ45 ports with auto MDI/MDI-X function
- Two SFP interfaces, supporting 1000BASE-X transceiver type auto detection

IFGS-624PTF Physical Port

- Four 10/100BASE-TX Fast Ethernet **IEEE 802.3at PoE+** RJ45 copper ports with auto MDI/MDI-X function
- Two SFP interfaces, supporting 1000BASE-X transceiver type auto detection

IFGS-1222TF Physical Port

- Eight 10/100BASE-TX RJ45 ports with auto MDI/MDI-X function (Port 1 to port 8).
- Two 10/100/1000BASE-T RJ45 ports with auto MDI/MDI-X function (Port 9 to port 10).
- Two SFP interfaces, supporting 1000BASE-X transceiver type auto detection (Port 11 to port 12).

One Key Ring Feature

- In a simple Ring network with **8 units**, the recovery time of data link can be as fast as 1ms.

Layer 2 Features

- Complies with IEEE 802.3 10BASE-T, IEEE 802.3u 100BASE-TX, IEEE 802.3ab 1000BASE-T and IEEE 802.3z 1000BASE-X Ethernet standard
- Supports auto-negotiation and 10/100Mbps half/full duplex mode and 10/100/1000Mbps half/full duplex mode
- Prevents packet loss with back pressure (half-duplex) and IEEE 802.3x pause frame flow control (full-duplex)
- High-performance Store and Forward architecture, broadcast storm control and runt/CRC filtering eliminate erroneous packets to optimize the network bandwidth
- PROFINET traffic pass-through with QoS
- IFGS-620TF/IFGS-624PTF Backplane (switching fabric): 4.8Gbps
- IFGS-1222TF Backplane (switching fabric): 9.6Gbps
- Integrated address look-up engine, supporting 4K absolute MAC addresses
- 16K jumbo packet size
- Automatic address learning and address aging
- IEEE 802.1p Class of Service (Works under Ring function disable)
- IEEE 802.1Q VLAN transparency
- CSMA/CD Protocol

Due to differences in algorithm between the Industrial Ring Ethernet Switch series one Key Ring and the ERPS Ring functions available on PLANET Industrial Managed Switch devices, the two functions are not compatible with each other. The Industrial Ring Ethernet Switch series One Key Ring function offers easier and faster deployment with DIP switch adjustments.

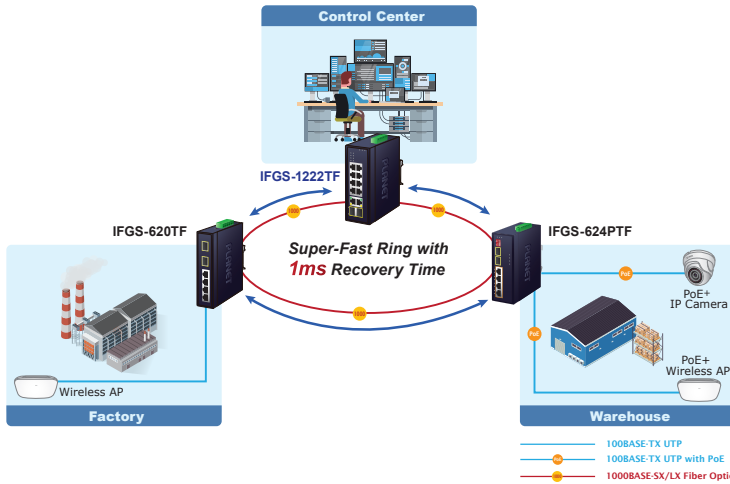

PROFINET Traffic with Higher Delivery Priority

The Industrial Ring Ethernet Switch series features a brand-new function that enhances support for recognizing the PROFINET traffic for higher delivery priority. Once the IFGS-624PTF receives the PROFINET traffic, it will forward the PROFINET traffic first, and then handle other Ethernet traffic. With this enhanced function, the Industrial Ring Ethernet Switch series will become the ideal Industrial Unmanaged Switch for the faster PROFINET traffic.

PLANET PROFINET Protocol Pass-through Industrial Switch

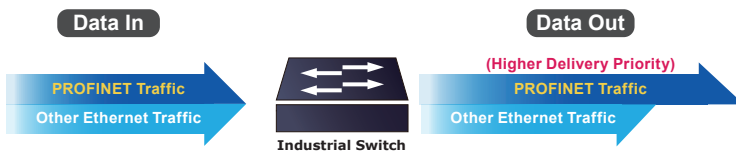

Fiber Optic Link Capability Enables Extension of Network Deployment

The Industrial Ring Ethernet Switch series two SFP ports are compatible with 1000BASE-X SFP (small form factor pluggable) fiber-optic transceivers. The fiber optic uplink capability guarantees the throughput to all nodes hooked into the network and the Gigabit Ethernet distance can be extended from 550 meters (Multi-mode fiber cable) to 120 kilometers (Single-mode fiber cable). They are well suited for applications within the factory data centers and distributions.

Thus, building a network solution of FTTH (Fiber to the Home), FTTC (Fiber to the Curb) for ISPs or FTTB (Fiber to the Building) for enterprises becomes so easy to users when long-distance deployment is employed. The Industrial Ring Ethernet Switch series can handle extremely large amounts of data in a secure topology linking to a metro switch, backbone or high-capacity server.

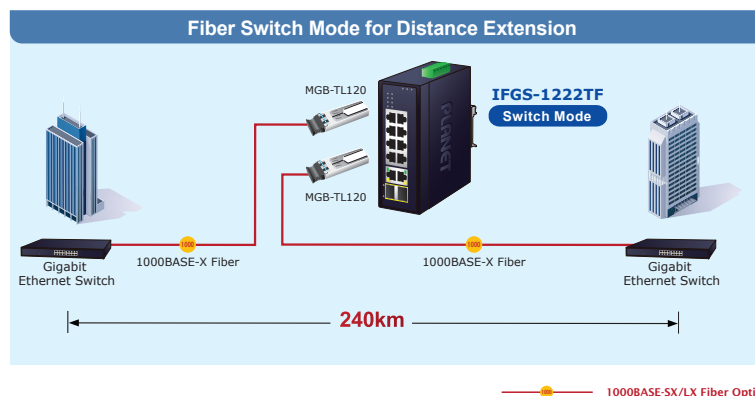

Industrial Case and Installation

- IP30 metal case (IFGS-620TF/IFGS-1222TF)
- IP40 metal case (IFGS-624PTF)
- DIN-rail, wall-mount or side wall-mount design for redundant power design
 - 9 to 48V DC, redundant power with reverse polarity protection (IFGS-620TF/IFGS-1222TF)
 - AC 24V power adapter acceptable (IFGS-620TF/IFGS-1222TF)
 - 12 to 54V DC, redundant power with reverse polarity protection (IFGS-624PTF)
- Supports 6000 VDC Ethernet ESD protection
- -40 to 75 degrees C operating temperature
- 4 real-time PoE power usage indicators
- Free fall, shock-proof and vibration-proof for industries

Power over Ethernet (IFGS-624PTF)

- Complies with IEEE 802.3at Power over Ethernet Plus, end-span PSE
- Backward compatible with IEEE 802.3af Power over Ethernet
- Up to 4 ports of IEEE 802.3af/at devices powered
- Up to 120-watt PoE budget
- Supports PoE power up to 36 watts for each PoE port
- Each port supports 54V DC power to PoE powered device
- Auto detects powered device (PD)
- Circuit protection prevents power interference between ports
- Remote power feeding up to 100m in standard mode with 250m in extend mode

Dual Power Input for High Availability Network System

The Industrial Ring Ethernet Switch series features a strong dual power input system with wide-ranging voltages (9V~48V DC or 24V AC for IFGS-620TF/IFGS-1222TF) or (12V~54V DC for IFGS-624PTF) incorporated into customer's automation network to enhance system reliability and uptime. In the example below, when power supply 1 fails to work, the hardware failover function will be activated automatically to keep powering the Industrial Ring Ethernet Switch series via power supply 2 alternatively without any loss of operation.

**Non-stop Ethernet Transmission
Dual Power Input with Auto Failover**

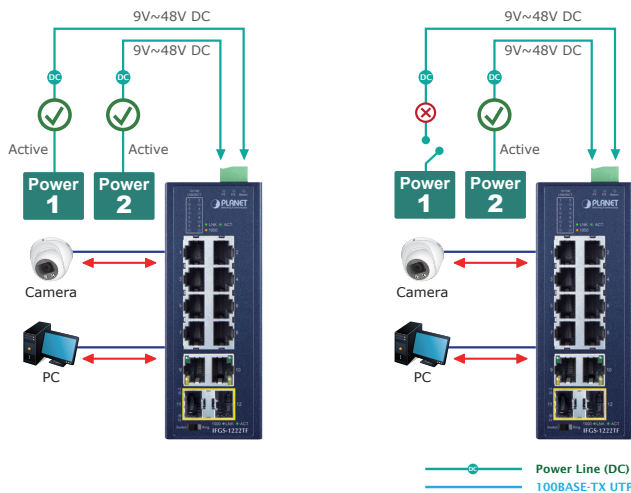

**Non-stop Ethernet Transmission
Dual Power Input with Auto Failover**

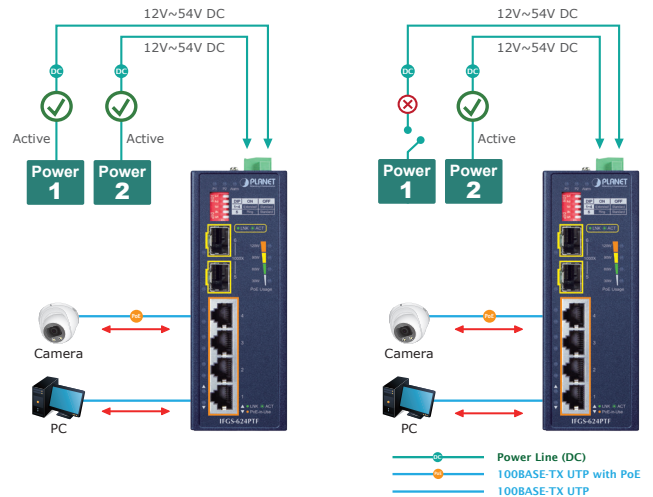

Robust Protection

The Industrial Ring Ethernet Switch series provides a contact discharge of $\pm 6\text{KV}$ DC and air discharge of $\pm 6\text{KV}$ DC for Ethernet ESD protection. It also supports $\pm 6\text{KV}$ surge immunity to improve product stability and protects users' networks from devastating ESD attacks, making sure the flow of operation does not fluctuate.

Flexible and Easy Installation with Limited Space

The Industrial Ring Ethernet Switch series is specially designed to be installed in a narrow environment, such as wall enclosure. It can be installed by fixed wall mounting or DIN rail, thereby making its usability more flexible and easier in any space-limited location.

Optional installation method



* The above pictures are for illustration only.

Low Power Consumption for Green Networking to implement ESG (IFGS-620TF/IFGS-1222TF)

The IFGS-620TF and IFGS-1222TF, adopting the advanced green networking technology, provides cable length power saving, and link-up and link-down power saving. These features make the IFGS-620TF and IFGS-1222TF consume very low power in full load operation mode, which helps conserve energy effectively but maintains high performance efficiently.

With the IEEE 802.3az Energy Efficient Ethernet (EEE) Protocol, the IFGS-620TF and IFGS-1222TF can automatically detect cable link status and network traffic, and thus is able to adjust power consumption accordingly. It enables the switch to consume less power when it is less active.

Convenient and Reliable Power System (IFGS-624PTF)

To facilitate the 802.3at PoE+ usage with the commonly-used 12~54V DC power input for transportation and industrial-level applications, the IFGS-624PTF adopts the **12~54V DC to 54V DC power boost technology** to solve power source issue but does not require special power supplies. Its wide-ranging voltages design is suitable for worldwide operability with high-availability applications requiring dual or backup power inputs.

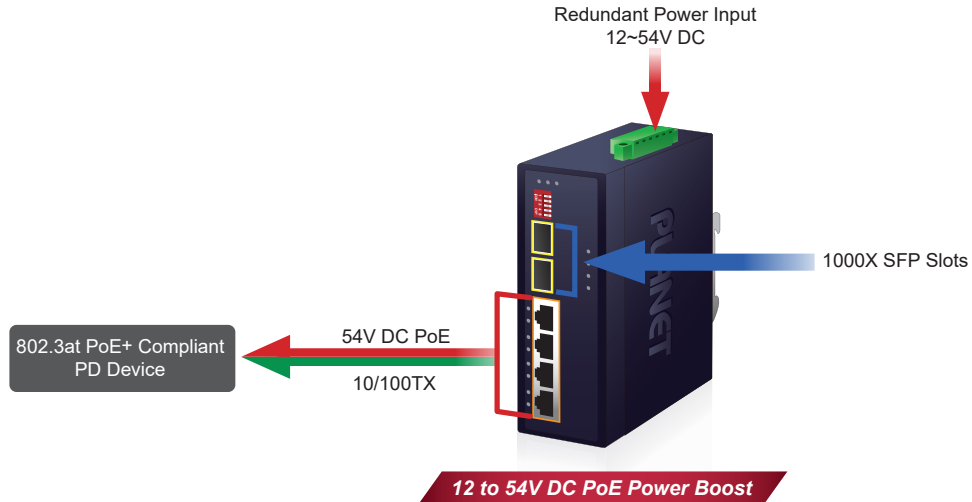

A Perfect Full PoE+ Power Solution Ideal for Hardened Environment (IFGS-624PTF)

With Plug and Play design, PLANET IFGS-624PTF Industrial-grade, DIN-rail type Unmanaged Fast Ethernet PoE+ Switch, featuring 4 **IEEE 802.3at PoE+10/100BASE-TX** ports and **two 1000BASE-X SFP fiber ports** for uplink connection, allows to automatically detect and configure internal and external peripherals. With a rugged **IP40** metal housing and **12-54V redundant power** system for a total power budget of up to **120 watts** for different kinds of PoE applications, the IFGS-624PTF also operates efficiently in harsh environments, with an operating **temperature range of -40 to 75 degrees Celsius**.

In response to the growing demand for IIoT (Industrial Internet of Things) infrastructure, the IFGS-624PTF is designed for easy deployment of industrial networks with its Plug and Play capability. Furthermore, it ensures stable and reliable fast data and power transmission. The IFGS-624PTF also supports PROFINET traffic pass-through with QoS, making it an ideal choice for integrating with industrial automation systems and enhancing communication between devices in a factory setting.



Intelligent LED Indicator for Real-time PoE Usage (IFGS-624PTF)

The IFGS-624PTF helps users to monitor the current status of PoE power usage easily and efficiently by its advanced LED indication. Called "**PoE Power Usage**", the front panel of the IFGS-624PTF has four orange LEDs indicating 30W, 60W, 90W and 120W of PoE power usage.

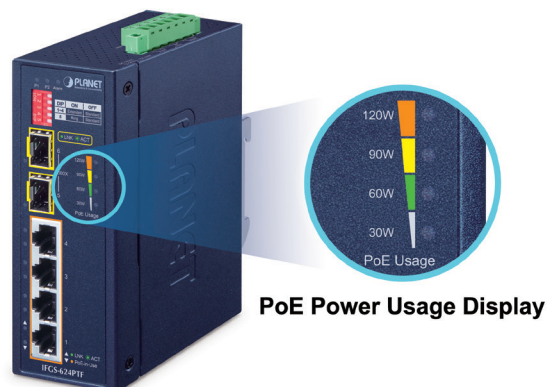

802.3at PoE+ Power and Ethernet Data Transmission Extension (IFGS-624PTF)

The IFGS-624PTF has a built-in solid DIP switch providing “Standard” and “Extend” operation modes for 802.3at PoE+ ports (Port 1 to Port 4). By default, the IFGS-624PTF operates as a normal IEEE 802.3af/at PoE+ Switch in the “Standard” operation mode. In the “Extend” operation mode, the IFGS-624PTF operates on a per-port basis at 10Mbps full duplex and can support 25-watt PoE power output over a distance of up to **250 meters**, overcoming the 100-meter limit of Ethernet UTP cable.

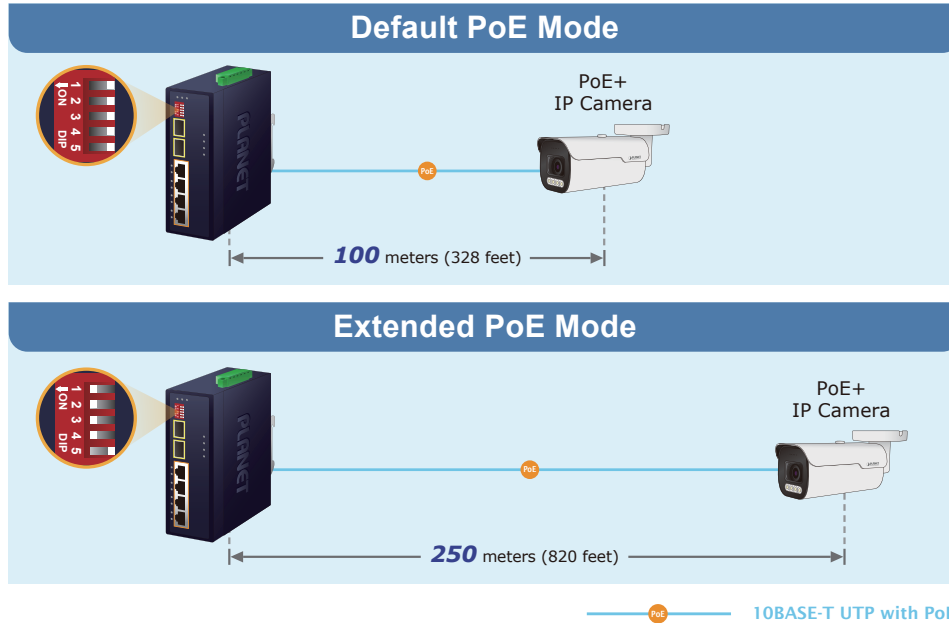

Applications

One Key Ring Makes Data Transmission Uninterrupted

The Industrial Ring Ethernet Switch series features strong rapid self-recovery capability to prevent interruptions and external intrusions. It incorporates the **super-fast, fault-tolerant ring redundancy technology** into customer’s automation network to enhance system reliability and uptime. The Industrial Ring Ethernet Switch series can easily help system integrators with the available network infrastructure to build wireless AP, IP camera and VoIP systems where power can be centrally-controlled. In a simple Ring network with **8 units**, the recovery time of data link can be as fast as **1ms**.

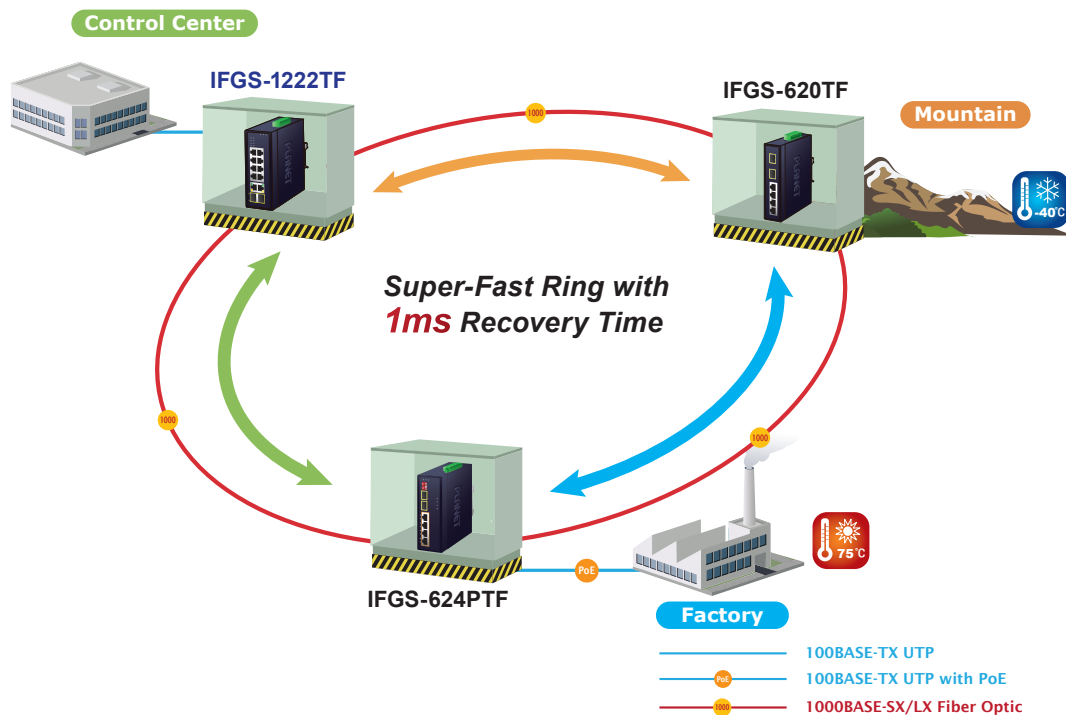

Ethernet Applications with Long-distance Fiber Uplink for Hardened Environment

The Industrial Ring Ethernet Switch series provides very high reliability and security features to make sure the continuous operation in harsh environments such as control cabinet of transportation, factory, outdoors and places where extreme low or high temperatures can be experienced. Moreover, the Industrial Ring Ethernet Switch series also compatible with 1000Mbps SFP transceivers to provide a strong, stable and long-distance connection and flexible industrial networking deployment.

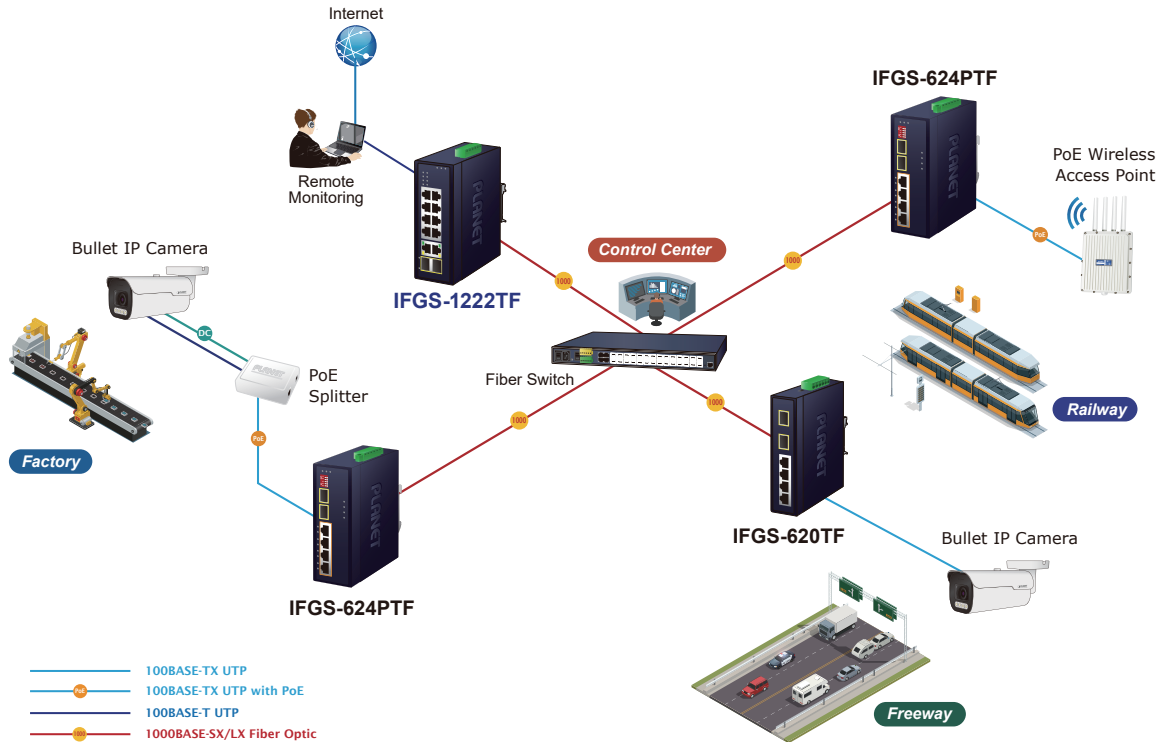

Fiber-optic Networking for ISPs, Enterprises, and Homes

With stable performance of data transmission and easy installation, the Industrial Ring Ethernet Switch series can build an ISP network solution of FTTH (Fiber to the Home), FTTC (Fiber to the Curb) for ISPs, or FTTB (Fiber to the Building) for enterprises in a small office network environment.

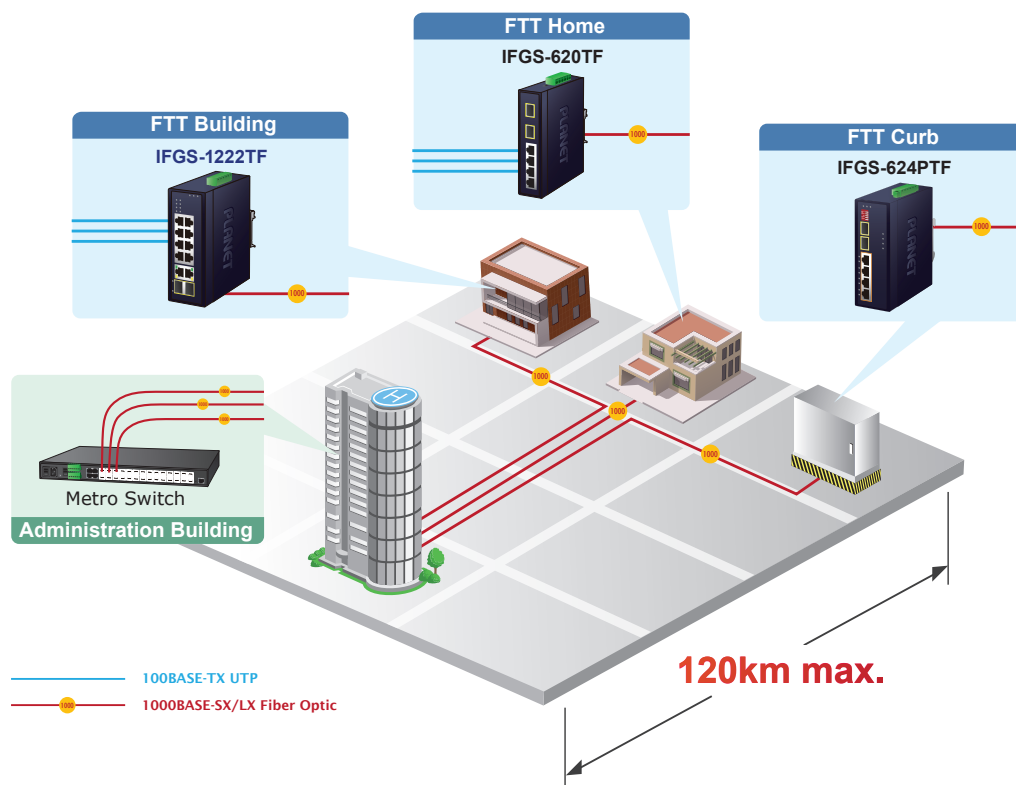

Industrial-grade PoE+ Switch for Building Automation and Security (IFGS-624PTF)

Suitable for buildings where security is strictly enforced, the IFGS-624PTF, with four Fast Ethernet 802.3at PoE+ in-line power interfaces, can easily build a power centrally controlled for an IP phone system, IP surveillance system, and wireless AP group in the harsh Industrial environment. For instance, 4 PoE IP cameras or PoE wireless APs can be easily installed for surveillance demands or a wireless roaming environment in the industrial area can be built. Without the power-socket limitation, the IFGS-624PTF makes the installation of IP cameras or wireless APs easier and more efficient.

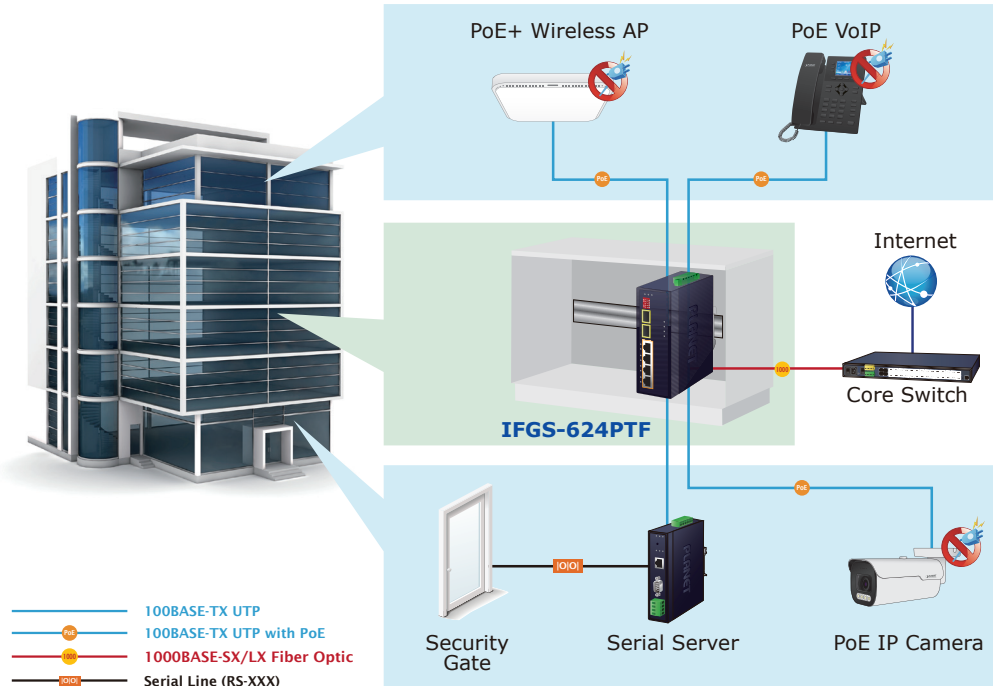

Dimensions

■ IFGS-620TF

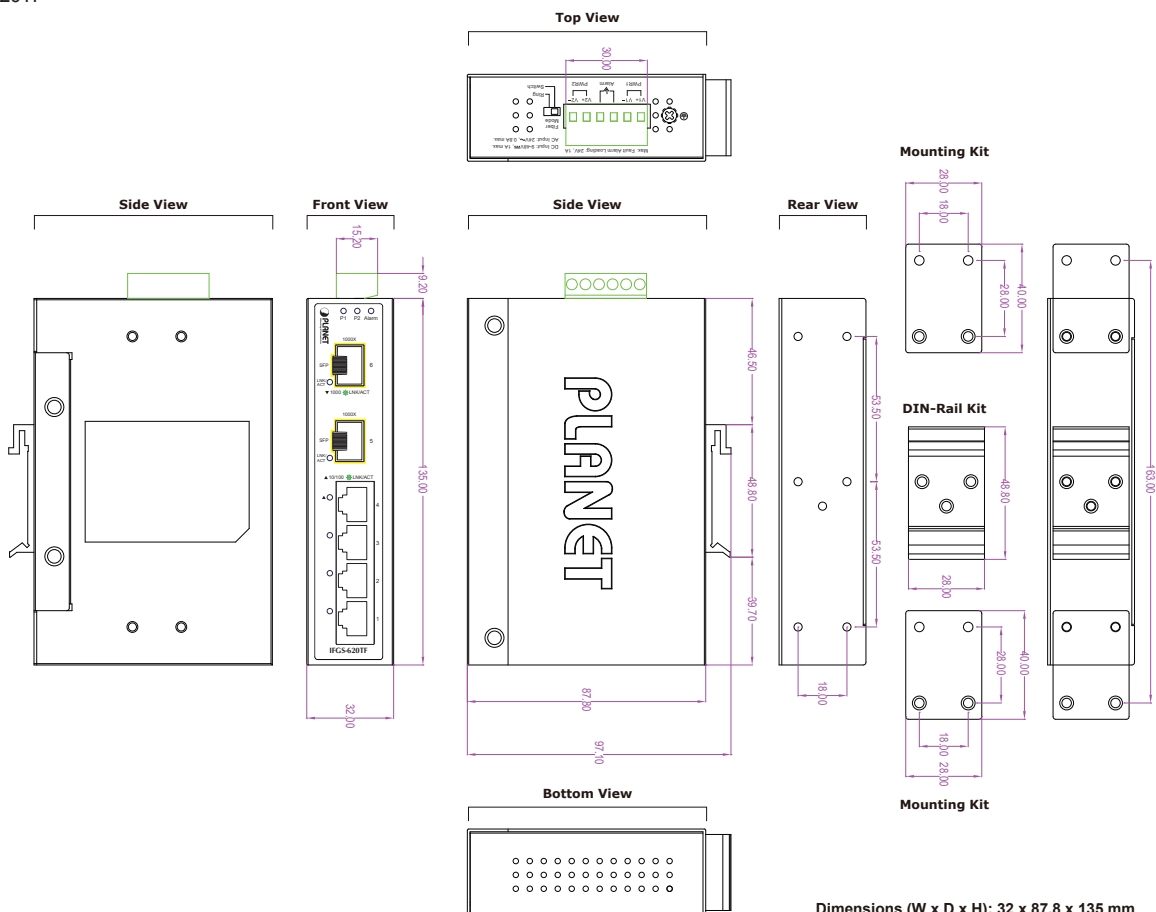

■ IFGS-624PTF

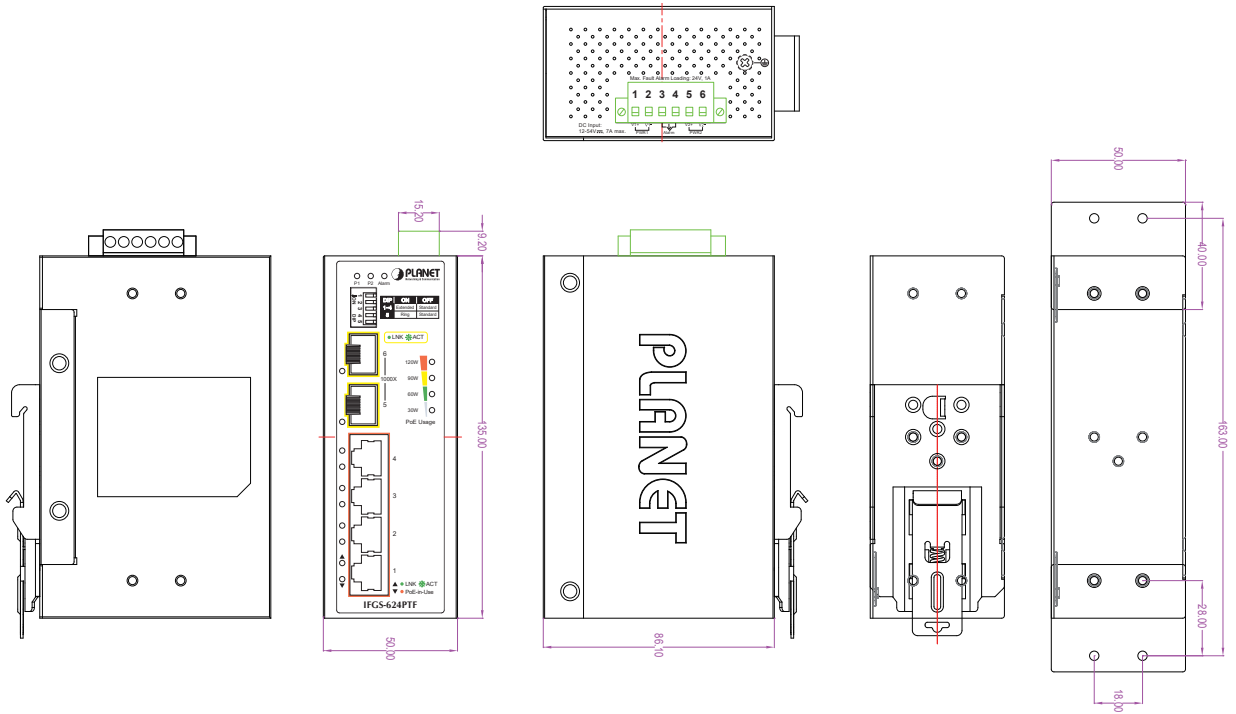

Dimensions (W x D x H): 50 x 86.1 x 135mm

■ IFGS-1222TF

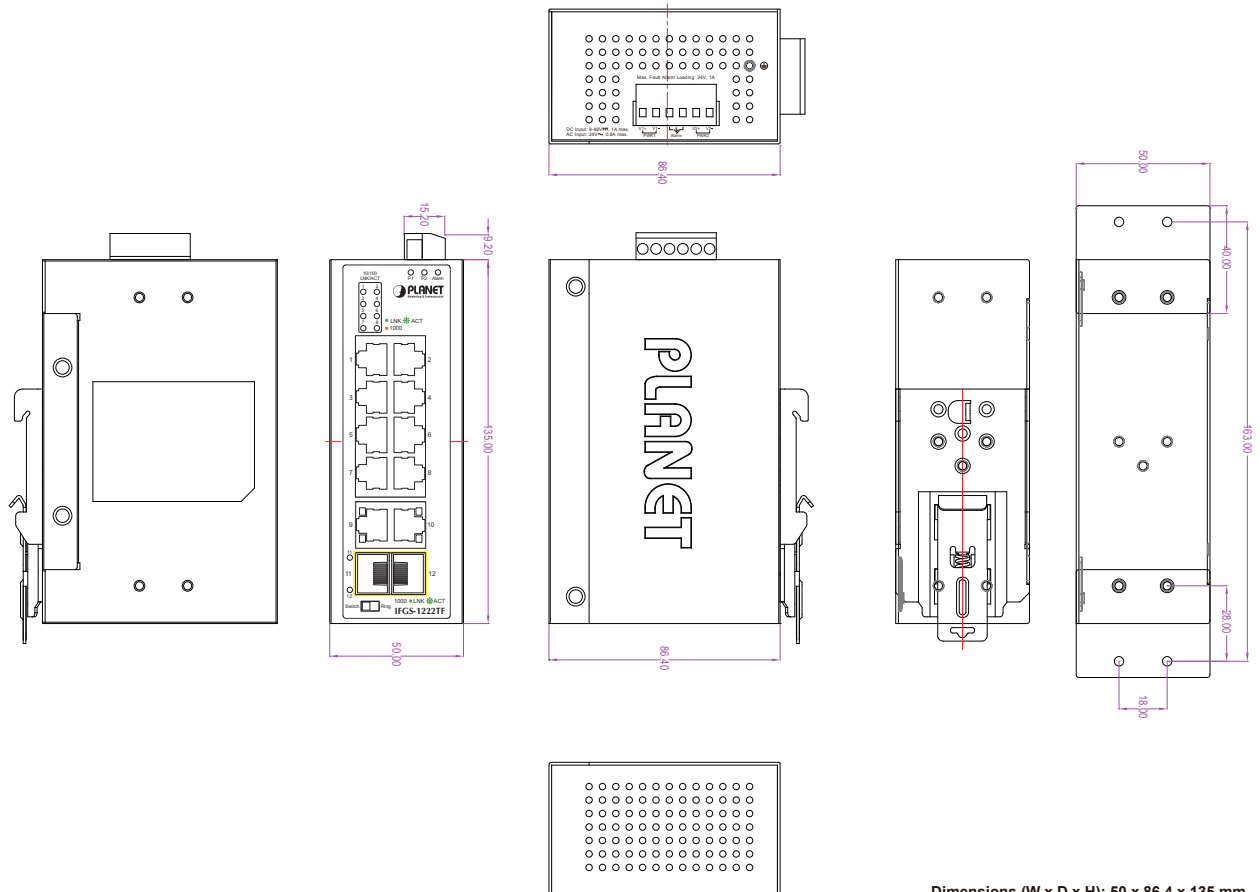

Dimensions (W x D x H): 50 x 86.4 x 135 mm

Specifications

Model	IFGS-1222TF	IFGS-620TF	IFGS-624PTF
Hardware Specifications			
Copper Ports	8 x 10/100BASE-TX RJ45 TP Auto-MDI/MDI-X, auto-negotiation	4 x 10/100BASE-TX RJ45 TP Auto-MDI/MDI-X, auto-negotiation	4 x 10/100BASE-TX RJ45 TP Auto-MDI/MDI-X, auto-negotiation
PoE Injector Port	2 x 10/100/1000BASE-T RJ45 TP	-	-
PoE Injector Ports	NA	NA	Four ports with 802.3at PoE+ injector function (Ports 1 to 4)
SFP Slots	2 x 1000BASE-X SFP interfaces		
DIP Switch	OFF: Fiber port Ring mode ON: Fiber port Switch mode	OFF: Fiber port Ring mode ON: Fiber port Switch mode	DIP 1-4: OFF: Standard mode ON: Port 1-4 Extend mode DIP-5: OFF: Fiber port Ring mode ON: Fiber port Switch mode
	<p>Note :</p> <ol style="list-style-type: none"> Power off the Industrial Ring Ethernet Switch before adjusting the DIP switch and then power it on. Extend mode: PoE transmission distance of 250m at speed of 10Mbps. (IFGS-624PTF). The Ring function can connect to a simple Ring network with up to 8 units; the recovery time of data link can be as fast as 1ms. Ring performance may vary depending on the length of the fiber optic and UTP cables. The active Ring function is not compatible with the IEEE 802.1p class of service function. 		
Connector	Removable 6-pin terminal block Pin 1/2 for Power 1; Pin 3/4 for fault alarm; Pin 5/6 for Power 2		
Alarm	Provides one relay output for power failure Alarm Relay current carry ability: 1A @ DC 24V		
ESD Protection	±6KV air gap discharge ±6KV contact discharge		
Surge Immunity	6KV DC		
Enclosure	IP30 metal case	IP30 metal case	IP40 metal case
Installation	DIN-rail kit and wall-mount ear		
Dimensions (W x D x H)	50 x 87.8 x 135mm	32 x 87.8 x 135mm	50 x 86.1 x 135mm
Weight	545g	430g	613g
Power Requirements	DC 9~48V or AC 24V Redundant power with reverse polarity protection	DC 9~48V or AC 24V Redundant power with reverse polarity protection	DC 12~54V Redundant power with reverse polarity protection
Power Consumption / Dissipation	DC 9V: 4.6 watts/15.6BTU DC 48V: 6 watts/20.4BTU AC 24V: 5.7 watts/19.4BTU	DC 9V: 3.3 watts/11.2BTU DC 48V: 3.4 watts/11.6BTU AC 24V: 3.4 watts/11.6BTU	DC 54V (System): Max. 7 watts/ 23.8BTU DC 54V (Ethernet + PoE Full Loading) Max. 140 watts/ 477BTU
LED	3 x LED for System and Power: ■ Green: Power 1 ■ Green: Power 2 ■ Red: Alarm	3 x LED for System and Power: ■ Green: Power 1 ■ Green: Power 2 ■ Red: Alarm	3 x LED for System and Power: ■ Green: DC Power 1 ■ Green: DC Power 2 ■ Red: Alarm
	Copper Ports (Ports 1 to 8): ■ Green: 10/100 LNK/ACT	Copper Ports (Ports 1 to 4): ■ Green: 10/100 LNK/ACT	Copper Ports (Ports 1 to 4): ■ Green: 10/100 LNK/ACT ■ Amber: PoE-in-Use
	SFP interfaces (Ports 11 to 12) ■ Green: 1G LNK/ACT	SFP interfaces (Ports 5 to 6) ■ Green: 1G LNK/ACT	SFP interface (Ports 5 to 6) ■ Green: 1G LNK/ACT
	2 x LED for Per Copper Port (Port-9~Port-10): ■ Green: LNK/ACT ■ Amber: 1000	-	4 x LED for PoE Usage (W) (Low to high): ■ Amber: 30W, 60W, 90W and 120W
Switch Specifications			
Switch Processing Scheme	Store-and-Forward		
Switch Fabric	9.6Gbps	4.8Gbps	4.8Gbps
Throughput (packet per second)	7.14Mpps@64bytes	3.57Mpps@64bytes	3.57Mpps@64bytes
Address Table	4K entries		
Jumbo Frame	16K bytes		

Flow Control	Back pressure for half duplex IEEE 802.3x pause frame for full duplex		
Power over Ethernet			
PoE Standard	-	-	IEEE 802.3at Power over Ethernet Plus/PSE
PoE Power Supply Type	-	-	End-span
Power Pin Assignment	-	-	1/2 (+), 3/6 (-)
PoE Power Output	-	-	Per port 54V DC Max. 36 watts
PoE Power Budget (max.)	-	-	120W max.@48-54V DC 100W max.@24V DC 60W max.@12V DC
Max. Number of Class 2 PDs	-	-	4
Max. Number of Class 3 PDs	-	-	4
Max. Number of Class 4 PDs	-	-	4
Standards Conformance			
Standards Compliance	IEEE 802.3 Ethernet 10BASE-T IEEE 802.3u Fast Ethernet 100BASE-TX IEEE 802.3ab Gigabit Ethernet 1000BASE-T (IFGS-1222TF) IEEE 802.3z Gigabit Ethernet 1000BASE-SX/LX IEEE 802.3x Full-Duplex Flow Control IEEE 802.1p Class of Service (Works under Ring function disable) IEEE 802.3af Power over Ethernet (IFGS-624PTF) IEEE 802.3at Power over Ethernet Plus(IFGS-624PTF) PROFINET Traffic Pass-through with QoS		
Regulatory Compliance	FCC Part 15 Class A, CE		
Stability Testing	IEC60068-2-32 (Free fall) IEC60068-2-27(Shock) IEC60068-2-6 (Vibration)		
Environment			
Temperature	Operating: -40~75 degrees C Storage: -40~75 degrees C		
Humidity	Operating: 5~95% (Non-condensing) Storage: 5~95% (Non-condensing)		

Ordering Information

IFGS-620TF	Industrial 4-Port 10/100TX + 2-Port 1000X SFP Ring Ethernet Switch (-40~75 degrees C)
IFGS-624PTF	Industrial 4-Port 10/100TX 802.3at PoE + 2-Port 1000X SFP Ring Ethernet Switch (-40~75 degrees C)
IFGS-1222TF	Industrial 8-Port 10/100TX + 2-Port 10/100/1000T + 2-Port 1000X SFP Ring Ethernet Switch (-40~75 degrees C)

Related Products

MGB-GT	SFP-Port 1000 BASE-T Module
MGB-LX	SFP-Port 1000 BASE-LX mini-GBIC module - 20km
MGB-SX	SFP-Port 1000 BASE-SX mini-GBIC module - 550m
MGB-SX2	SFP-Port 1000 BASE-SX mini-GBIC module - 2km
MGB-L40	SFP-Port 1000 BASE-LX mini-GBIC module - 40km
MGB-L80	SFP-Port 1000 BASE-LX mini-GBIC module - 80km
MGB-L120	SFP-Port 1000 BASE-LX mini-GBIC module - 120km
MGB-LA10	SFP-Port 1000 BASE-BX (WDM, TX:1310nm) mini-GBIC module - 10km
MGB-LB10	SFP-Port 1000 BASE-BX (WDM, TX:1550nm) mini-GBIC module - 10km
MGB-LA20	SFP-Port 1000 BASE-BX (WDM, TX:1310nm) mini-GBIC module - 20km
MGB-LB20	SFP-Port 1000 BASE-BX (WDM, TX:1550nm) mini-GBIC module - 20km
MGB-LA40	SFP-Port 1000 BASE-BX (WDM, TX:1310nm) mini-GBIC module - 40km
MGB-LB40	SFP-Port 1000 BASE-BX (WDM, TX:1550nm) mini-GBIC module - 40km
MGB-LA80	SFP-Port 1000 BASE-BX (WDM, TX:1490nm) mini-GBIC module - 80km
MGB-LB80	SFP-Port 1000 BASE-BX (WDM, TX:1550nm) mini-GBIC module - 80km
MGB-TSX	SFP-Port 1000 BASE-SX mini-GBIC module - 550m (-40 ~ 85 degrees C)
MGB-TSX2	SFP-Port 1000 BASE-SX mini-GBIC module - 2km (-40 ~ 85 degrees C)
MGB-TL40	SFP-Port 1000 BASE-LX mini-GBIC module - 40km (-40 ~ 85 degrees C)
MGB-TL80	SFP-Port 1000 BASE-LX mini-GBIC module - 80km (-40 ~ 85 degrees C)
MGB-TLA10	SFP-Port 1000 BASE-BX (WDM, TX:1310nm) mini-GBIC module - 10km (-40 ~ 85 degrees C)
MGB-TLB10	SFP-Port 1000 BASE-BX (WDM, TX:1550nm) mini-GBIC module - 10km (-40 ~ 85 degrees C)
MGB-TLA20	SFP-Port 1000 BASE-BX (WDM, TX:1310nm) mini-GBIC module - 20km (-40 ~ 85 degrees C)
MGB-TLB20	SFP-Port 1000 BASE-BX (WDM, TX:1550nm) mini-GBIC module - 20km(-40 ~ 85 degrees C)
MGB-TLA40	SFP-Port 1000 BASE-BX (WDM, TX:1310nm) mini-GBIC module - 40km (-40 ~ 85 degrees C)
MGB-TLB40	SFP-Port 1000 BASE-BX (WDM, TX:1550nm) mini-GBIC module - 40km (-40 ~ 85 degrees C)
MGB-TLA80	SFP-Port 1000 BASE-BX (WDM, TX:1490nm) mini-GBIC module - 80km (-40 ~ 85 degrees C)
MGB-TLB80	SFP-Port 1000 BASE-BX (WDM, TX:1550nm) mini-GBIC module - 80km (-40 ~85 degrees C)