

## User's Manual

**IGT-902 / 902T**  
**IGT-902S / 902TS**  
**IGT-905A**

**10/100/1000Base-T to 1000Base-SX / LX**  
**Industrial Managed Media Converter**



## Trademarks

Copyright © PLANET Technology Corp. 2010.

Contents subject to which revision without prior notice.

PLANET is a registered trademark of PLANET Technology Corp. All other trademarks belong to their respective owners.

## Disclaimer

PLANET Technology does not warrant that the hardware will work properly in all environments and applications, and makes no warranty and representation, either implied or expressed, with respect to the quality, performance, merchantability, or fitness for a particular purpose.

PLANET has made every effort to ensure that this User's Manual is accurate; PLANET disclaims liability for any inaccuracies or omissions that may have occurred.

Information in this User's Manual is subject to change without notice and does not represent a commitment on the part of PLANET. PLANET assumes no responsibility for any inaccuracies that may be contained in this User's Manual. PLANET makes no commitment to update or keep current the information in this User's Manual, and reserves the right to make improvements to this User's Manual and/or to the products described in this User's Manual, at any time without notice.

If you find information in this manual that is incorrect, misleading, or incomplete, we would appreciate your comments and suggestions.

## FCC Warning

This equipment has been tested and found to comply with the limits for a Class A digital device, pursuant to Part 15 of the FCC Rules. These limits are designed to provide reasonable protection against harmful interference when the equipment is operated in a commercial environment. This equipment generates, uses, and can radiate radio frequency energy and, if not installed and used in accordance with the Instruction manual, may cause harmful interference to radio communications. Operation of this equipment in a residential area is likely to cause harmful interference in which case the user will be required to correct the interference at whose own expense.

## CE Mark Warning

This is a Class A product. In a domestic environment, this product may cause radio interference, in which case the user may be required to take adequate measures.

## WEEE Warning



To avoid the potential effects on the environment and human health as a result of the presence of hazardous substances in electrical and electronic equipment, end users of electrical and electronic equipment should understand the meaning of the crossed-out wheeled bin symbol. Do not dispose of WEEE as unsorted municipal waste and have to collect such WEEE separately.

## Revision

PLANET Industrial Managed Gigabit Ethernet Media Converter User's Manual

**FOR MODELS:** IGT-902 / IGT-902T / IGT-902S / IGT-902TS / IGT-905A

**REVISION:** 1.2 (JULY.2010)

**Part No.:** 2080-AA1130-004

## TABLE OF CONTENTS

<b>1. INTRODUCTION .....</b>	<b>5</b>
1.1 Package Contents .....	5
1.2 How to Use This Manual .....	5
1.3 Product Description .....	6
1.4 Applications .....	6
1.5 Product Features .....	7
1.6 Product Specification .....	8
<b>2. HARDWARE INSTALLATION .....</b>	<b>10</b>
2.1 IGT-90X Front Panel .....	10
2.1.1 LED Indicators .....	11
2.1.2 IGT-90X Rear Panel .....	11
2.1.3 Wiring the Power Inputs .....	12
2.1.4 Wiring the Fault Alarm Contact .....	13
2.2 Mounting Installation .....	14
2.2.1 DIN-Rail Mounting .....	14
2.2.2 Wall Mount Plate Mounting .....	15
2.2.3 Stand-alone Installation .....	16
<b>3. INDUSTRIAL MEDIA CONVERTER MANAGEMENT .....</b>	<b>19</b>
3.1 Overview .....	19
3.2 Requirements .....	19
3.3 Management Methods .....	20
3.3.1 Web Management .....	20
3.3.2 Login the Industrial Managed Media Converter .....	20
3.3.3 SNMP Management .....	21
3.3.4 PLANET Smart Discovery Utility .....	21
<b>4. WEB MANAGEMENT .....</b>	<b>24</b>
4.1 Main Menu .....	24
4.2 System .....	25
4.2.1 System Information .....	25
4.2.2 IP Configuration .....	26
4.2.3 Password Setting .....	27
4.2.4 Firmware Upgrade .....	28
4.2.5 SNMP Management .....	31

---

4.2.6 Factory Default .....	33
4.2.7 System Reboot .....	35
4.3 Port Management .....	37
4.3.1 Port Configuration .....	37
4.3.2 Port Status .....	40
4.3.3 Port Statistics .....	41
4.4 Converter Configuration .....	42
4.5 VLAN .....	43
4.5.1 VLAN Group .....	45
4.5.2 VLAN Per Port Setting .....	47
4.5.3 Q-in-Q VLAN Setting .....	48
4.6 Quality of Service .....	49
4.7 OAM Setup .....	52
4.7.1 Local TS-1000 OAM Setup .....	52
4.7.2 Remote TS-1000 OAM Setup .....	53
4.7.3 TS-1000 Loop Back Test .....	55
4.7.4 802.3ah Setup .....	57
4.7.5 802.3ah Loop Back Test .....	58
4.8 Security .....	60
4.9 Logout .....	61
<b>5. TROUBLE SHOOTING .....</b>	<b>62</b>
<b>APPENDIX A NETWORKING CONNECTION.....</b>	<b>63</b>
A.1 Device's RJ-45 Pin Assignments .....	63
A.2 RJ-45 Cable Pin Assignment .....	63
A.3 Fiber Optical Cable Connection Parameter .....	64

# 1. INTRODUCTION

## 1.1 Package Contents

Check the contents of your package for following parts:

- Industrial Managed Gigabit Ethernet Media Converter x1
- CD-ROM User's Manual x1
- Quick Installation Guide x1
- Wall Mount Kit x1
- Rack Mount Kit x1

If any of these are missing or damaged, please contact your dealer immediately, if possible, retain the carton including the original packing material, and use them against to repack the product in case there is a need to return it to us for repair.



IGT-905A is with one vacant SFP module slot. The 1000Base-SX / LX SFP module is not bundled with in the package.

## 1.2 How to Use This Manual

The Industrial Managed Media Converter User's Manual is structured as followings:

### Section 2, Hardware Installation

It explains the functions of Industrial Managed Media Converter and how to install the Industrial Managed Media Converter.

### Section 3, Industrial Media Converter Management

It contains information about how to manage the Industrial Managed Media Converter.

### Section 4, Web Management

It contains information about the Web management function from the Industrial Managed Media Converter.

### Section 5, Troubleshooting

It contains troubleshooting guide of Industrial Managed Media Converter.

### Appendix A

It contains cable information of Industrial Managed Media Converter.

The term of "**Industrial Managed Media Converter**" In the following section of this user's manual means the IGT-90X.

## 1.3 Product Description

The Industrial Managed Media Converter IGT-90X provide conversion between 10/100/1000Base-T and 1000Base-SX /LX network. There are SC / LC connectors and single-mode / multi-mode media for your needs. Ethernet signal that allows two type segments connect easily, efficiently and inexpensively.

The Industrial Managed Media Converter equipped with remote Web / SNMP interface. With its built-in Web-based management, the Industrial Managed Media Converter offers an easy-to-use, platform-independent management and configuration facility and can be programmed for advanced management functions. Such as IP address Configuration / DHCP Client function, password setting / firmware upgrade, system reboot / factory default, port configuration that include TP / Fiber port speed duplex mode setting, flow control setting and Ingress/Egress bandwidth control setting, converter configuration that include maximum packet length setting, Broadcast / Multicast / Unicast storm control setting, 16 IEEE 802.1Q VLAN groups support and powerful Q-in-Q VLAN function, Quality of Service (QoS), TS-1000 / IEEE 802.3ah OAM function and TCP & UDP filter function. It supports standard Simple Network Management Protocol (SNMP) and can be managed via any standard-based management software as well.

With Gigabit mini GBIC interface, the IGT-905A is with high reliability and flexibility to extend the distance from 220m to 120Km. It depends on the Gigabit mini GBIC modules.

## 1.4 Applications

### Access Control System – Traditional Installation

#### Industrial area Media Converter for data receive and forwarding

Most of the enterprises performed centralize manage to remote access machine or other network equipment via Internet network or Fiber optical network. With connection to IGT-90X which cans extensible distance of network, IGT-90X not only provides higher speed transfer but also could be managed by remote Web interface. The Fiber extend distance can be up to 10km on IGT-902S/902TS and 120km on IGT-905A or 550m on IGT-902/902T in a local range.

The Gigabit port supporting 9K jumbo packet can handle large amounts of data transmission in a secure topology linking to a backbone Switch or high-power servers. The Industrial Managed Media Converter with the slim type IP 30 metal shape is ideal for most Heavy Industrial demanding environments.

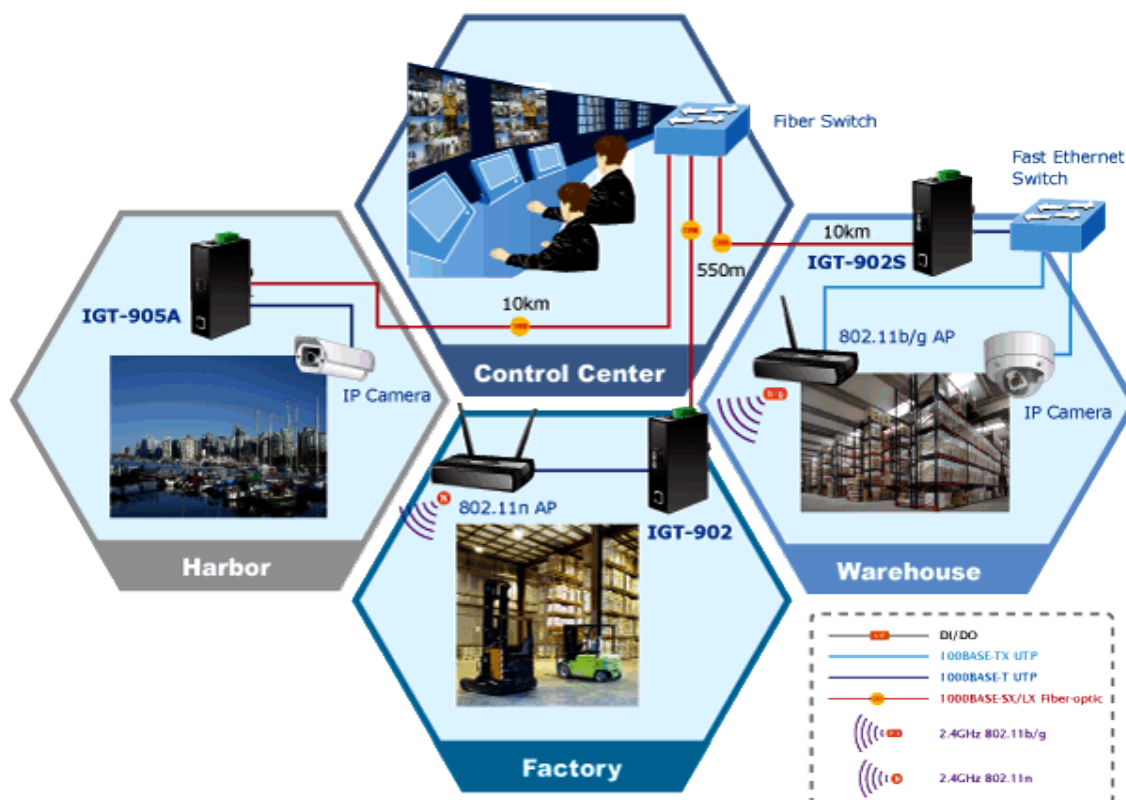

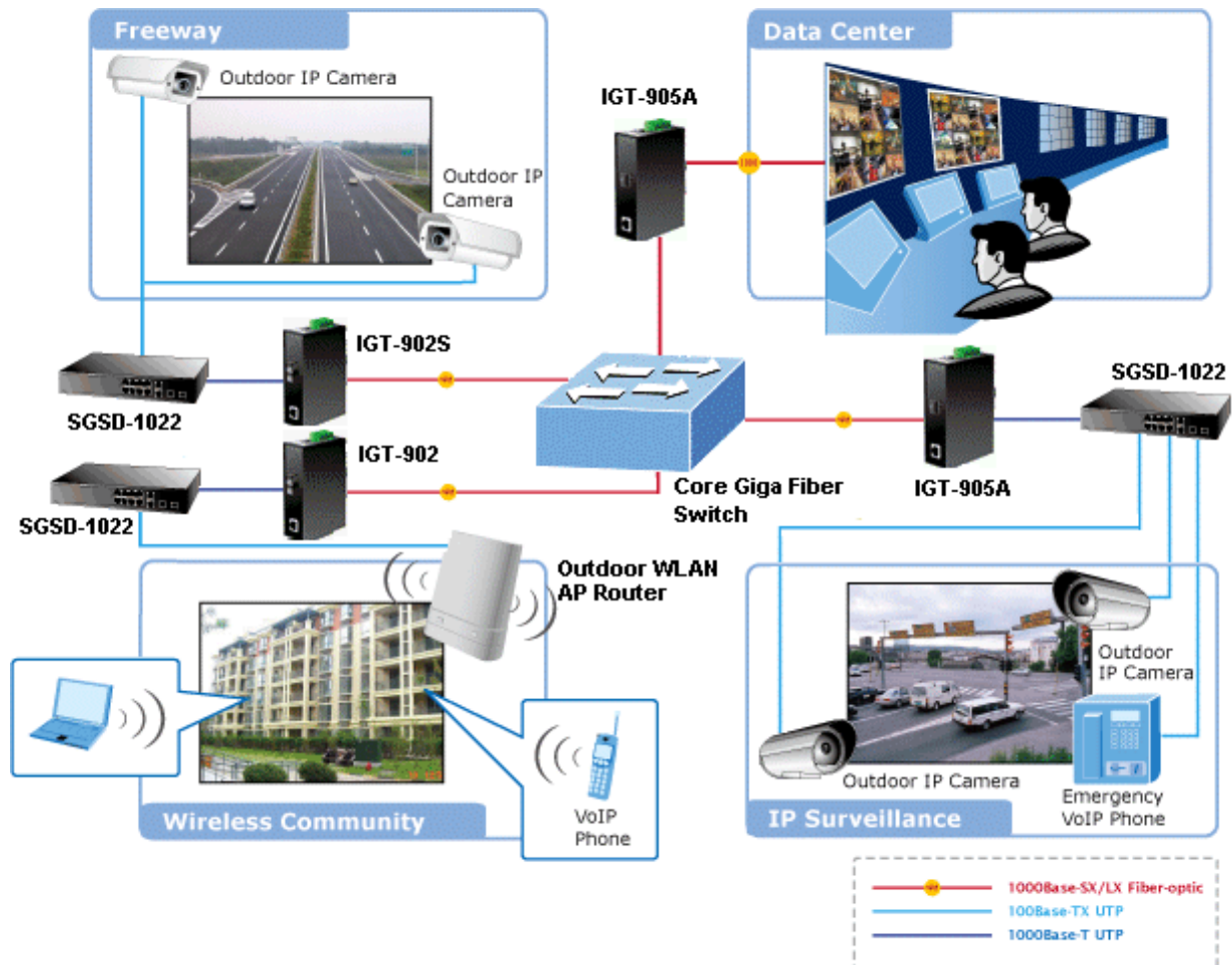

## 1.5 Product Features

### ➤ Interface

- 1-Port 10/100/1000Base-T RJ-45 with Auto-negotiation and Auto-MDI/MDI-X function
- 1 Port 1000Base-SX SC interface, provide long distance up to 220/550m on **IGT-902/902T**
- 1 Port 1000Base-LX SC interface, provides long distance for 10km on **IGT-902S/902TS**
- 1 Mini-GBIC slot, port provides multi choice of SFP modules on **IGT-905A**

### ➤ Industrial Conformance

- 12 to 48V DC, redundant power with polarity reverse protect function
- -10 to 60 Degree C operation temperature for IGT-902 / 902S
- -30 to 75 Degree C operation temperature for IGT-902T / 902TS / 905A
- IP-30 metal case
- Relay alarm for port breakdown
- Supports 6KVDC Ethernet ESD protection
- Free fall, Shock and Vibration Stability
- DIN-Rail and Wall-mountable hardware design

### ➤ Layer 2 Features

- Store-and-Forward mechanism
- Prevents packet loss with back pressure (Half-Duplex) and IEEE 802.3x PAUSE frame flow control (Full-Duplex)
- Maximum frame size to 9216 Bytes
- Loop detection / Broadcast / Multicast / Unicast storm control
- Supports VLANs
  - IEEE 802.1Q Tagged based VLAN
  - Up to 16 VLANs groups, out of 4K VLAN IDs

- Management VLAN

### ➤ **Quality of Service**

- Ingress/Egress Bandwidth control on TP / Fiber port
- 4 priority queues, strict priority and Weighted Round Robin (WRR)
- Traffic classification by:
  - IEEE 802.1p Class of Service
  - IP DSCP priority
  - IP Address priority

### ➤ **Management**

- Built-in IP-based Web interface for remote management
- SNMP v1 / v2c and 4 RMON groups
- Event trap and SNMP trap support
- Manual IP address setting / DHCP client for IP address assignment
- TS-1000 OAM / IEEE 802.3ah OAM / Loop Back Test
- 16 TCP / UDP Filter groups
- Password setting, IP setting and devices description setting through Planet Smart discovery utility
- Firmware upgrade via remote Web interface
- Reset Button at the front panel for the factory default reset

## 1.6 Product Specification

Product	IGT-902	IGT-902T	IGT-902S	IGT-902TS	IGT-905A
<b>Hardware Specification</b>					
<b>Copper Interface</b>	1 x 10/100/1000Base-T RJ-45 Auto-MDI/MDI-X ports				
<b>Optic Interface</b>	<b>SC</b>			<b>SFP</b>	
<b>Optical Mode</b>	<b>Multi-mode</b>		<b>Single mode</b>		<b>Vary on module</b>
<b>Optic Wavelength</b>	<b>850nm</b>		<b>1310nm</b>		-*
<b>Launch Power(dBm)</b>	<b>MAX.</b>	-4 dBm	-3 dm		-*
	<b>Min.</b>	-9.5 dBm	-9.5dBm		-*
<b>Receive Sensitivity</b>	-13.5 dBm		-14.4 dBm		-*
<b>Maximum Input power</b>	-18 dBm		-20 dBm		-*
<b>Speed</b>	<b>Twisted-pair</b>	10/20Mbps for Half / Full-Duplex 100/200Mbps for Half / Full-Duplex 2000Mbps for Full-Duplex			
	<b>Fiber-optic</b>	2000Mbps for Full-Duplex			
<b>Cable</b>	<b>Twisted-pair</b>	10Base-T: 2-pair UTP Cat. 3,4,5, up to 100 m 100Base-TX: 2-pair UTP Cat. 5, up to 100 m 1000Base-T: 4-pair STP Cat 5,6 up to 100m			
	<b>Fiber-optic Cable</b>	<ul style="list-style-type: none"> <li>• 50/125µm or 62.5/125µm multi-mode fiber cable, up to 220/550m.</li> <li>• 9/125µm single-mode cable, provides long distance for 10/15/20/30/40/50/60/70/120km (very on fiber transceiver or SFP module)</li> </ul>			
<b>LED indicator</b>	Power: P1, P2, Fault TP: LNK/ACT, 1000 Fiber: LNK/ACT				



<b>Power Input</b>	12 to 48V DC Redundant power with polarity reverse protection function				
<b>Power Consumption</b>	7.7 Watts/ 26 BTU (maximum)				
<b>Operating Temperature</b>	-10~60 Degree C	-30~75 Degree C	-10~60 Degree C	-30~75 Degree C	-30~75 Degree C
<b>Operating Humidity</b>	5~90% non-condensing				
<b>Storage Temperature</b>	-20~85 Degree C	-40~85 Degree C	-20~85 Degree C	-40~85 Degree C	-40~85 Degree C
<b>Storage Humidity</b>	5~90% non-condensing				
<b>Dimension (W x D x H)</b>	13.5 x 8.5 x 3.2 mm				
<b>Weight</b>	423g				
<b>Installation</b>	DIN rail kit and wall mount ear				
<b>Management and Layer 2 Features</b>					
<b>Management Interface</b>	WEB / SNMP v1, v2c				
<b>Port Configuration</b>	Port disable/enable Auto-negotiation 10/100/1000Mbps Full and Half duplex mode selection. Flow Control disable / enable. Bandwidth control on each port.				
<b>VLAN</b>	IEEE 802.1q Tagged Based VLAN , 4K VLAN ID, up to 16 VLAN groups Q-in-Q VLAN				
<b>QoS</b>	Traffic classification based on : <ul style="list-style-type: none"> <li>• 802.1p priority</li> <li>• IP DSCP field in IP Packet</li> <li>• IP Address</li> </ul>				
<b>Bandwidth Control</b>	Ingress / Egress bandwidth control <ul style="list-style-type: none"> <li>• Rate range: 512kbps to 500Mbps</li> </ul> Storm control <ul style="list-style-type: none"> <li>• Broadcast / Multicast / Unknown Unicast packet</li> </ul>				
<b>Standard Conformance</b>					
<b>Emissions</b>	FCC Class A, CE Class A				
<b>Standard</b>	IEEE 802.3 10BASE-T IEEE 802.3u 100BASE-TX IEEE 802.3z Gigabit SX/LX IEEE 802.3ab Gigabit 1000T IEEE 802.3x Flow Control and Back pressure IEEE 802.1p Class of service IEEE 802.1Q VLAN Tagging IEEE 802.3ah OAM				
<b>Stability</b>	IEC60068-2-32 (Free fall) IEC60068-2-27 (Shock) IEC60068-2-6 (Vibration)				

\* =Depend on the various SFP modules

## 2. HARDWARE INSTALLATION

This product provides three different running speeds – 10Mbps, 100Mbps and 1000Mbps in the same Industrial Managed Media Converter and automatically distinguishes the speed of incoming connection.

This section describes the functionalities of IGT-90X's components and guides how to install it on the DIN Rail Basic knowledge of networking is assumed. Please read this chapter completely before continuing.

### 2.1 IGT-90X Front Panel

The Front Panel of the Industrial Managed Media Converter consists of one 1000Base-SX / 1000Base-LX / mini-GBIC SFP ports and one Auto-Sensing 10/100/1000Mbps Ethernet RJ-45 Port. [Figure 2-1](#), [2-2](#), [2-3](#), [2-4](#) & [2-5](#) shows a front panel of Industrial Managed Media Converter.

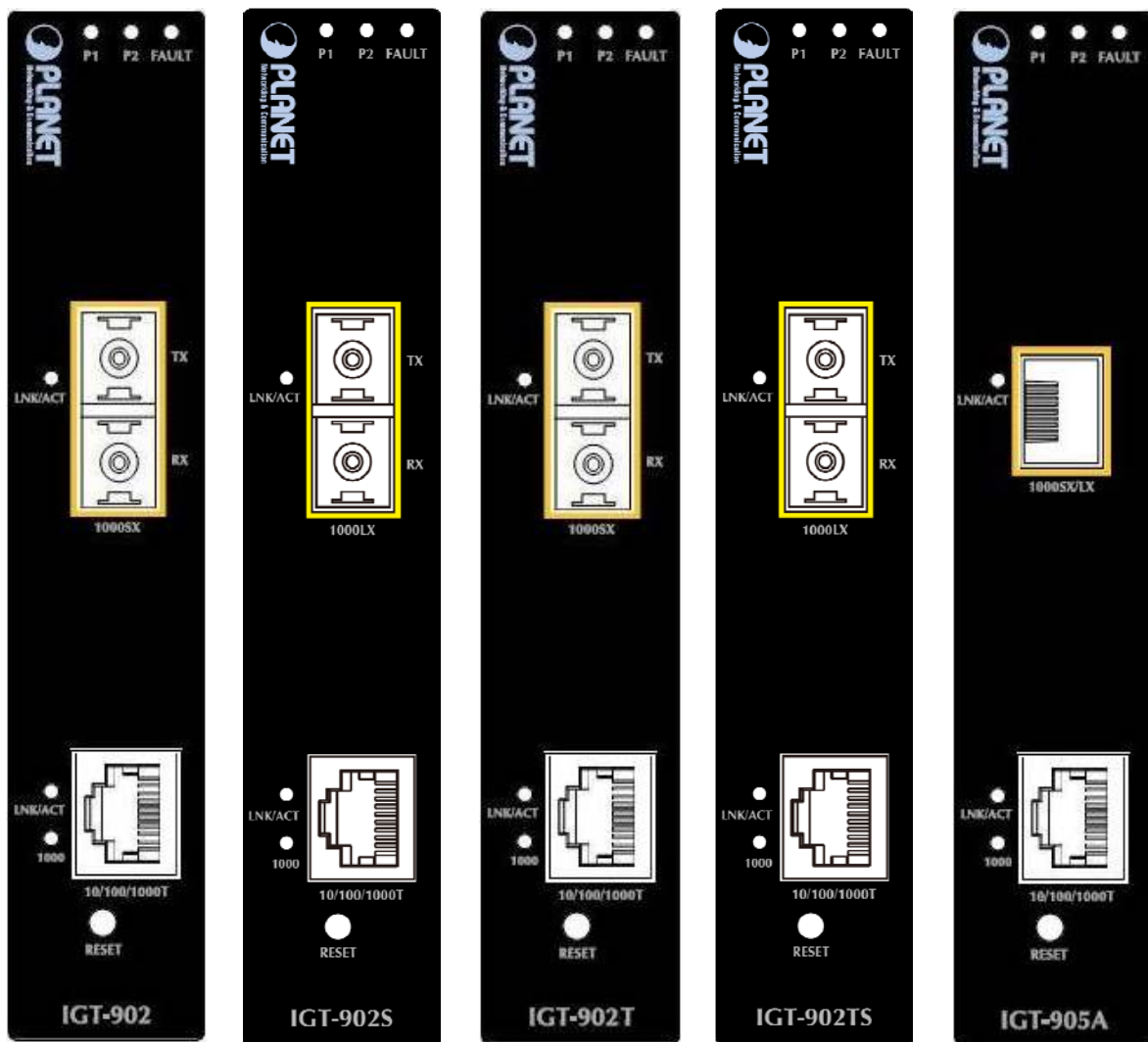

**Figure 2-1 & 2-2** PLANET IGT-902 / IGT-902S Front Panel

**Figure 2-3 & 2-4** PLANET IGT-902T / IGT-902TS Front Panel

**Figure2-5** PLANET IGT-905A Front Panel

### 2.1.1 LED Indicators

LED	Color	Function	
P1	Green	Lit	Indicate the power 1 has power.
P2	Green	Lit	Indicate the power 2 has power.
FAULT	Green	Lit	Indicate the either power 1 or power 2 has no power.
Fiber LNK /ACT	Green	Lights	To indicate that the Fiber Optical Port is successfully connecting to the network at 1000Mbps.
		Blinks	To indicate the Fiber Optical Port is receiving or sending data.
TP 1000	Green	Lights	To indicate that the Gigabit Ethernet Port is successfully connecting to the network at 1000Mbps. OFF indicate the Gigabit Ethernet Port is successfully connecting to the network at 10/100Mbps.
TP LNK /ACT		Lights	To indicate that the Gigabit Ethernet Port is successfully connecting to the network at 10/100/1000Mbps.
		Blinks	To indicate the Gigabit Ethernet Port is receiving or sending data.

To press and release the RESET button. The IGT-90X will back to the factory default mode. Be sure that you backup the current configuration of IGT-90X; else the entire configuration will be erased when pressing the "RESET" button.



- Press and release the RESET button shortly, the device will be rebooted.
- Press the RESET button about 10 seconds and release, the device will back to the factory default mode; the entire configuration will be erased to default setting.

### 2.1.2 IGT-90X Rear Panel

The upper panel of the Industrial Managed Media Converter consist one terminal block connector within two DC power inputs. Figure 2-6 shows the upper panel of the Industrial Managed Media Converter.

#### ■ IGT-90X series Upper Panel

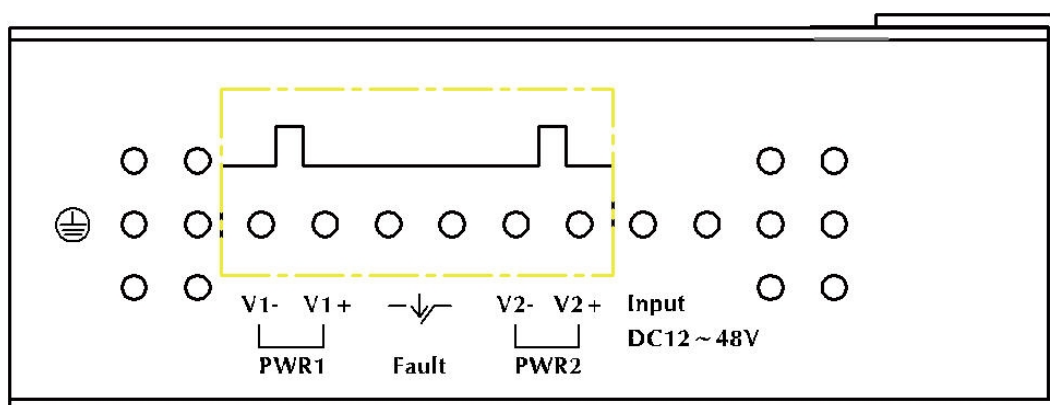
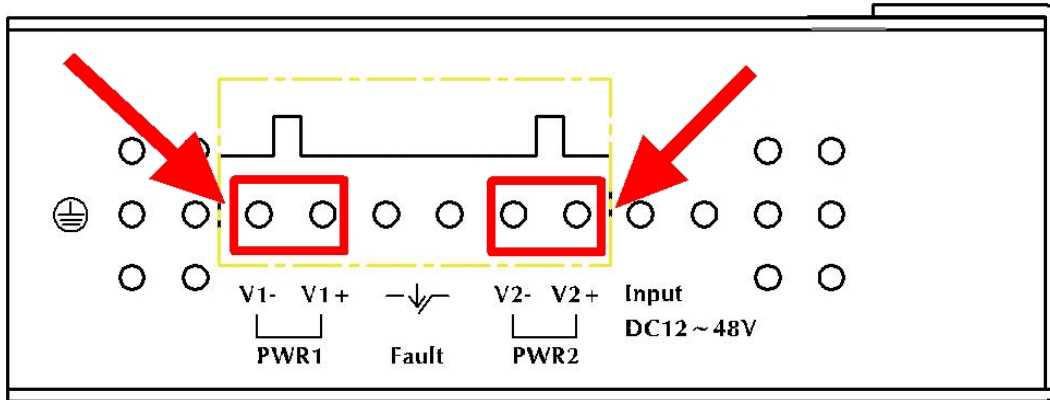

Figure 2-6 Upper Panel of IGT-90X

### 2.1.3 Wiring the Power Inputs

The 6-contact terminal block connector on the top panel of Industrial Media Converter is used for two DC redundant powers input. Please follow the steps below to insert the power wire.

1. Insert positive / negative DC power wires into the contacts 1 and 2 for POWER 1, or 5 and 6 for POWER 2.



2. Tighten the wire-clamp screws for preventing the wires from loosing.



1	2	3	4	5	6
Power 1		Fault		Power 2	
-	+			-	+



Note

The wire gauge for the terminal block should be in the range between 12 ~ 24 AWG.

### 2.1.4 Wiring the Fault Alarm Contact

The fault alarm contacts are in the middle of the terminal block connector as the picture shows below. Inserting the wires, the Industrial Management Media Converter will detect the fault status of the power failure, or port link failure (available for managed model) and then forms an open circuit. The following illustration shows an application example for wiring the fault alarm contacts.

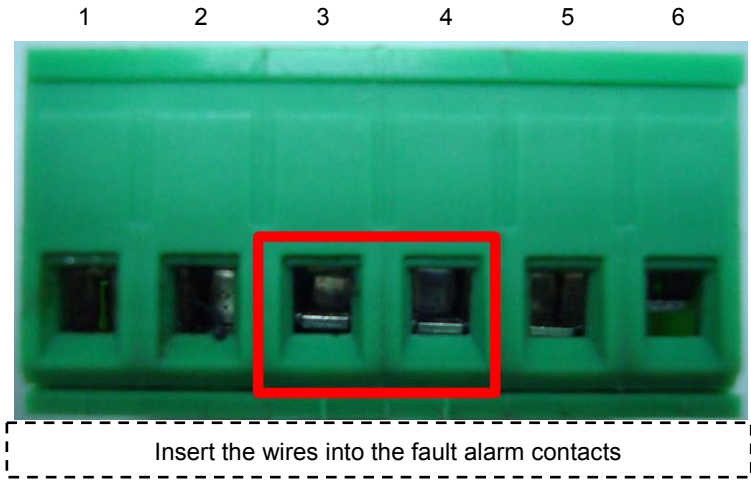

- 1. The wire gauge for the terminal block should be in the range between 12 ~ 24 AWG.
- 2. Alarm relay circuit accepts up to 30V, max. 3A currents.

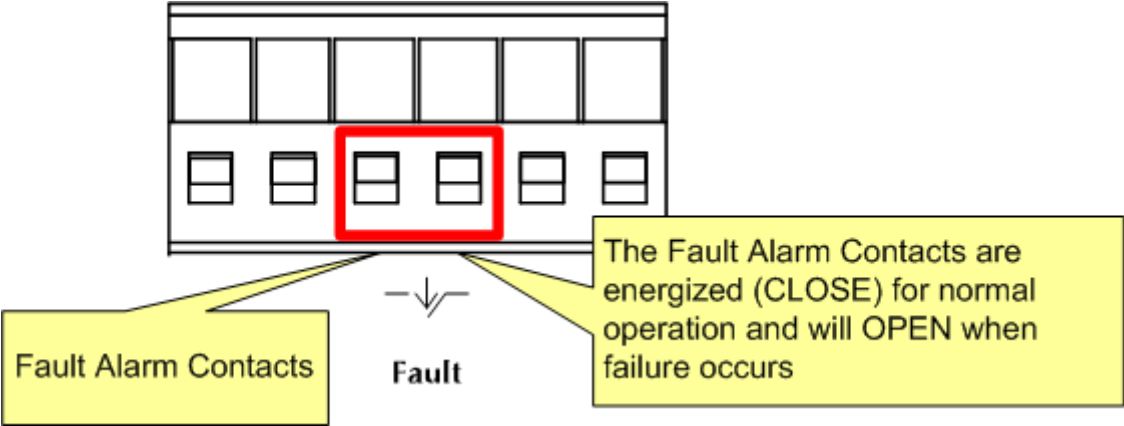

## 2.2 Mounting Installation

This section describes how to install the Industrial Managed Media Converter and make connections to it. Please read the following topics and perform the procedures in the order being presented.



In the installation steps below, this Manual use IGS-801(PLANET 8 Port Industrial Gigabit Switch) as the example. However, the steps for PLANET Industrial Switch & Industrial Media / Serial Converter are similar. Terms of “**Industrial Equipment**” in following section means the PLANET Industrial devices that mentioned above.

### 2.2.1 DIN-Rail Mounting

The DIN-Rail is screwed on the Industrial Equipment when out of factory. When need to replace the wall mount application with DIN-Rail application on Industrial Equipment, please refer to following figures to screw the DIN-Rail on the Industrial Equipment. To hang the Industrial Equipment, follow the below steps:

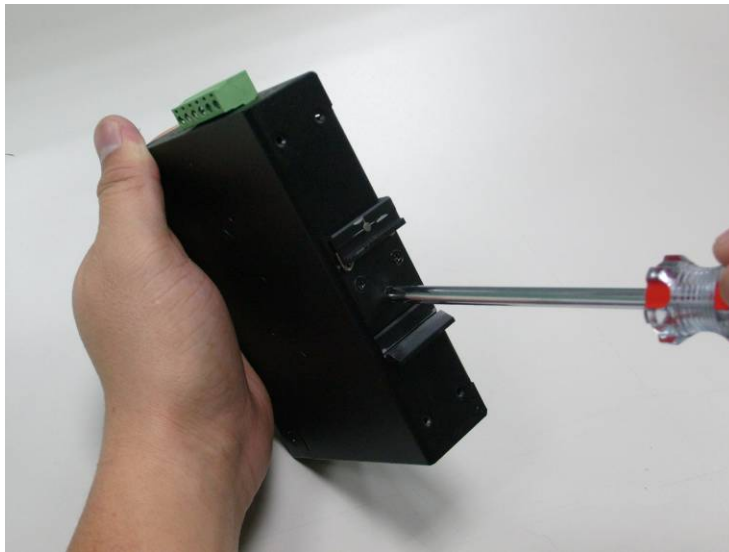

**Step 1:** screw the DIN-Rail on the Industrial Managed Media Converter.



**Step 2:** Lightly press the button of DIN-Rail into the track.



**Step 3:** Check the DIN-Rail is tightly on the track.

**Step 4:** Please refer to following procedures to remove the Industrial Gigabit Ethernet Switch from the track.



**Step 5:** Lightly press the button of DIN-Rail for remove it from the track.

### 2.2.2 Wall Mount Plate Mounting

To install the Industrial Equipment on the wall, please follows the instructions described below.

**Step 1:** Remove the DIN-Rail from the Industrial Equipment; loose the screws to remove the DIN-Rail.

**Step 2:** Place the wall mount plate on the rear panel of the Industrial Equipment.



**Step 3:** Use the screws to screw the wall mount plate on the Industrial Equipment.

**Step 4:** Use the hook holes at the corners of the wall mount plate to hang the Industrial Equipment on the wall.

**Step 5:** To remove the wall mount plate, reverse steps above.

### 2.2.3 Stand-alone Installation

#### IGT-902 / IGT-902T / IGT-902S / IGT-902TS Installation:

To install an Industrial Managed Media Converter stand-alone, on a Track or wall mount, simply complete the following steps:

**Step 1:** Turn off the DC power of the device/station in a network to which IGT-90X will be attached.

**Step 2:** Ensure that there is no activity in the network.

**Step 3:** Attach fiber cable from the Industrial Managed Media Converter to the fiber network. TX, RX must be paired at both ends.

**Step 4:** Connect the DC power to the IGT-90X and verify that the Power LED lights up.

**Step 5:** Turn on the power of the device/station; the PWR LED (Green) should light when all cables are attached.

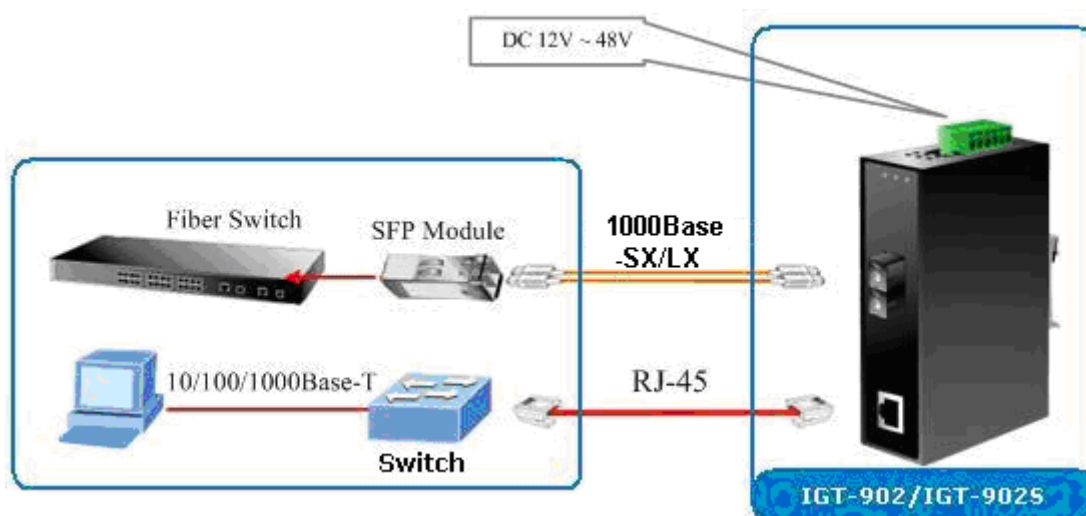

**Figure 2-7** IGT- 902 / IGT-902T / IGT-902S / IGT-902TS stand-alone installation





Please refers to APPENDIX-A for detailed wiring information of the Industrial Managed Media Converter. To prevent from optic acceptor malfunction, check the both wires / transmitter before power on the Industrial Managed Media Converter.

### IGT-905A Installation:

IGT-905A is with high reliability and flexibility to extend the distance from 220m to 120Km. It depends on the Gigabit mini GBIC modules. The SFP transceivers are hot-plug and hot-swappable. You can plug-in and out the transceiver to/from any SFP port without having to power down the Industrial Managed Media Converter.

To install IGT-905A with 1000Base-SX / LX SFP, simply complete the following steps:

**Step 1:** Precede with the steps 4 and steps 5 of session **2.2.3 Stand-alone Installation** to connect the network cabling and supply power to your Industrial Managed Media Converter.

**Step 2:** Slot in the 1000Base-SX / LX SFP. Make sure both side of the SFP transceiver are with the same media type, for example: 1000Base-SX / 220m & 550m to 1000Base-SX / 220m & 550m, 1000Base-LX / 10km to 1000Base-LX / 10km

**Step 3:** Connect the fiber cable. Attach the duplex LC connector on the network cable into the SFP transceiver.

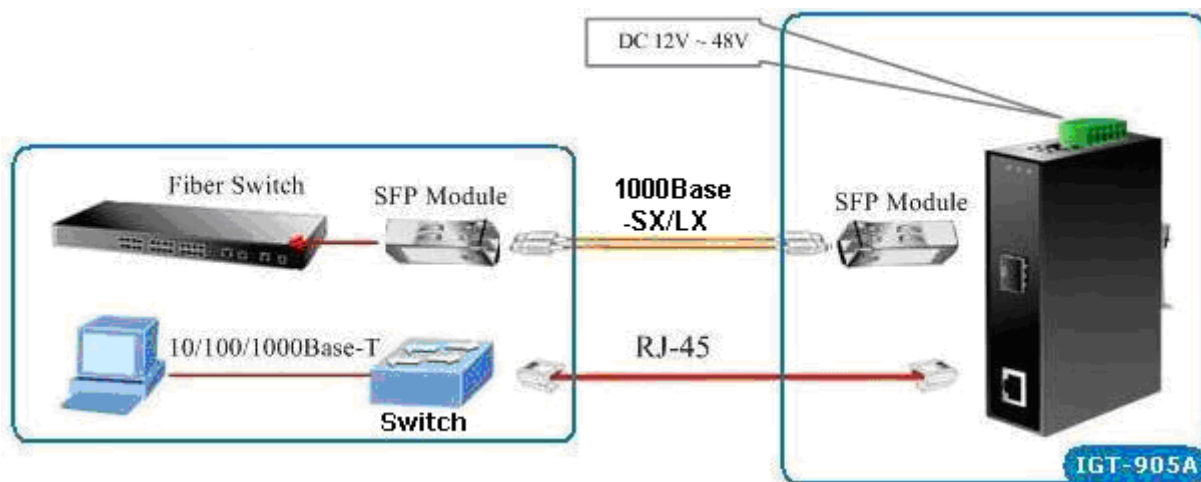

Figure 2-8 IGT- 905A stand alone installation



It recommends using PLANET MGB series 1000Base-SX / LX / LX WDM SFP on the IGT-905A. If you insert a SFP transceiver that is not supported, the IGT-905A will not recognize it.

The following list the available Modules for IGT-905A

<b>MGB-GT</b>	SFP-Port 1000Base-T mini-GBIC module
<b>MGB-SX</b>	SFP-Port 1000Base-SX mini-GBIC module
<b>MGB-LX</b>	SFP-Port 1000Base-LX mini-GBIC module
<b>MGB-L30</b>	SFP-Port 1000Base-LX mini-GBIC module -30KM
<b>MGB-L50</b>	SFP-Port 1000Base-LX mini-GBIC module -50KM
<b>MGB-L70</b>	SFP-Port 1000Base-LX mini-GBIC module -70KM
<b>MGB-L120</b>	SFP-Port 1000Base-LX mini-GBIC module -120KM

---

<b>MGB-LA10</b>	SFP-Port 1000Base-LX mini-GBIC module- LC WDM(TX:1310nm), SM,10km
<b>MGB-LB10</b>	SFP-Port 1000Base-LX mini-GBIC module- LC WDM(TX:1550nm), SM,10km
<b>MGB-LA20</b>	SFP-Port 1000Base-LX mini-GBIC module- LC WDM(TX:1310nm), SM,20km
<b>MGB-LB20</b>	SFP-Port 1000Base-LX mini-GBIC module- LC WDM(TX:1550nm), SM,20km
<b>MGB-LA40</b>	SFP-Port 1000Base-LX mini-GBIC module- LC WDM(TX:1310nm), SM,40km
<b>MGB-LB40</b>	SFP-Port 1000Base-LX mini-GBIC module- LC WDM(TX:1550nm), SM,40km
<b>MGB-TSX</b>	SFP-Port 1000Base-SX mini-GBIC module - 550m (-40~75°C)
<b>MGB-TLX</b>	SFP-Port 1000Base-LX mini-GBIC module - 10km (-40~75°C)
<b>MGB-TL30</b>	SFP-Port 1000Base-LX mini-GBIC module - 30km (-40~75°C)
<b>MGB-TL70</b>	SFP-Port 1000Base-LX mini-GBIC module - 70km (-40~75°C)

## 3. INDUSTRIAL MEDIA CONVERTER MANAGEMENT

This chapter describes how to manage the Industrial Managed Media Converter. Topics include:

- Overview
- Management methods
- Assigning an IP address to the Industrial Managed Media Converter
- Logging on to the Industrial Managed Media Converter

### 3.1 Overview

This chapter gives an overview of Industrial Managed Media Converter management. The IGT-90X provides a simply WEB **browser interface**. Using this interface, you can perform various Industrial Managed Media Converter configuration and management activities, including:

- **System**
- **Port Management**
- **Converter Configuration**
- **VLAN**
- **Quality of Service**
- **OAM Setup**
- **Security**
- **Logout**

Please refer to the following Chapter 4 for more details.

### 3.2 Requirements

- Network cables.
  - For IGT-90x copper interface: Use standard network (UTP) cables with RJ-45 connectors.
  - For IGT-90x Fiber interface: Use Multi-mode or Single-mode fiber patch cord with SC connectors.
- Subscriber PC installed with Ethernet NIC (Network Card)
- Workstations of subscribers running Windows 98/ME, NT4.0, 2000/2003/XP, MAC OS X or later, Linux, UNIX or other platform compatible with TCP/IP protocols.
- Above PC installed with WEB Browser, such as Microsoft Internet Explore or Mozilla Firefox



It is recommended to use **Internet Explore 7.0** or above to access Industrial Media Converter.

### 3.3 Management Methods

The way to manage the IGT-90X:

- Web Management via a network or dial-up connection.
- Using SNMP Network Management Station.

#### 3.3.1 Web Management

The PLANET Industrial Managed Media Converter provides a built-in browser interface. You can manage the Industrial Managed Media Converter remotely by having a remote host with Web browser, such as Microsoft Internet Explorer, Netscape Navigator or Mozilla Firefox.



Figure 3-1 Web Management over Ethernet

#### 3.3.2 Login the Industrial Managed Media Converter

The following shows how to startup the Web Management of the Industrial Managed Media Converter, please note the device is configured through an Ethernet connection, make sure the manager PC must be set on the **same IP subnet address**.

For example, the default IP address of the Industrial Managed Media Converter is **192.168.0.100** (the factory-default IP address), then the manager PC should be set at 192.168.0.x (where x is a number between 1 and 254, except 100), and the default subnet mask is 255.255.255.0.

Use Internet Explorer 7.0 or above Web browser, enter default IP address <http://192.168.0.100>

After entering the username and password (default user name and password is “**admin**”) in login screen then the Web main screen appears.

Default IP Address: **192.168.0.100**

Default Account: **admin**

Default Password: **admin**

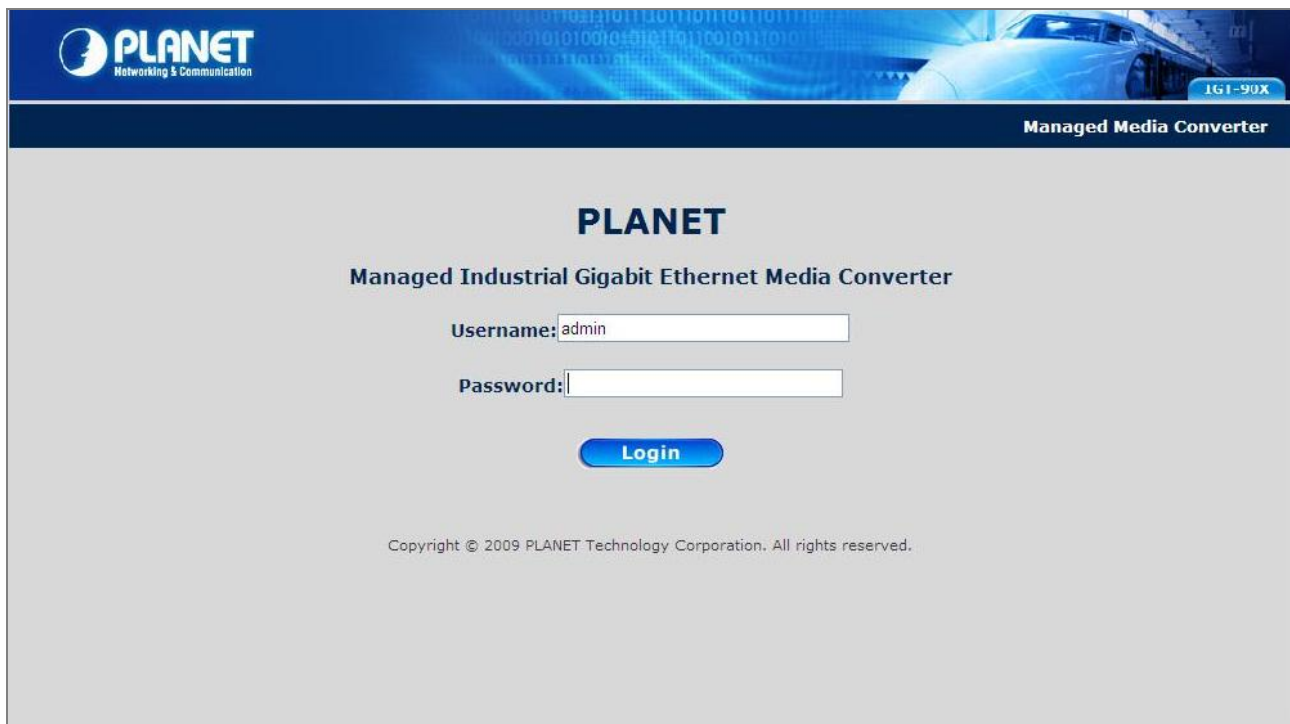

**Figure 3-2** Login Web Page screen



1. For security reason, please change and memorize the new password after this first setup.
2. Only accept command in lowercase letter under web interface.

### 3.3.3 SNMP Management

You can manage the Industrial Managed Media Converter across a LAN using an SNMP Network Management Station with a graphical user interface.

This management method lets you monitor statistical counters and set Industrial Managed Media Converter parameters from the remote Network Management Station.

Using this management method:

- The network must run the IP protocol.
- The Managed Media Converter must have an IP address.

### 3.3.4 PLANET Smart Discovery Utility

For easily list the Industrial Managed Media Converter in your Ethernet environment, the Planet Smart Discovery Utility from user's manual CD-ROM is an ideal solution.

The following install instructions guiding you for run the Planet Smart Discovery Utility.

1. Deposit the Planet Smart Discovery Utility in administrator PC.
2. Run this utility and the following screen appears.

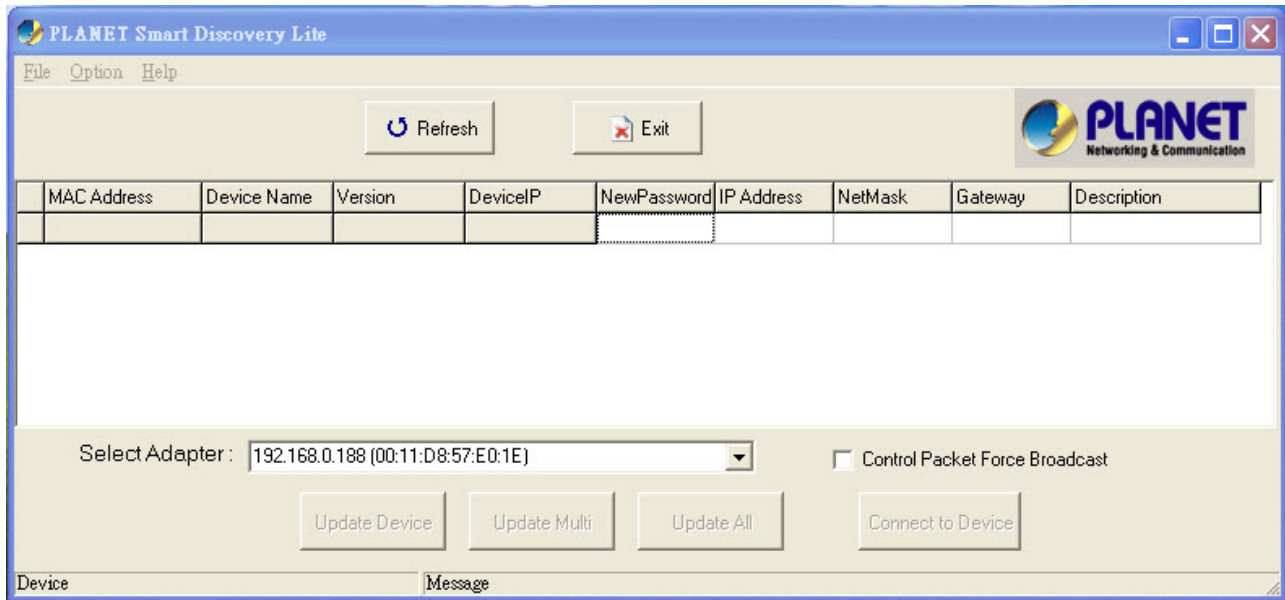

Figure 3-3 Planet Smart Discovery Utility Screen



Note

If there are two LAN cards or above in the same administrator PC, choose different LAN card by use the “**Select Adapter**” tool.

3. Press “**Refresh**” button for list current connected devices in the discovery list, the screen is shown as follow.

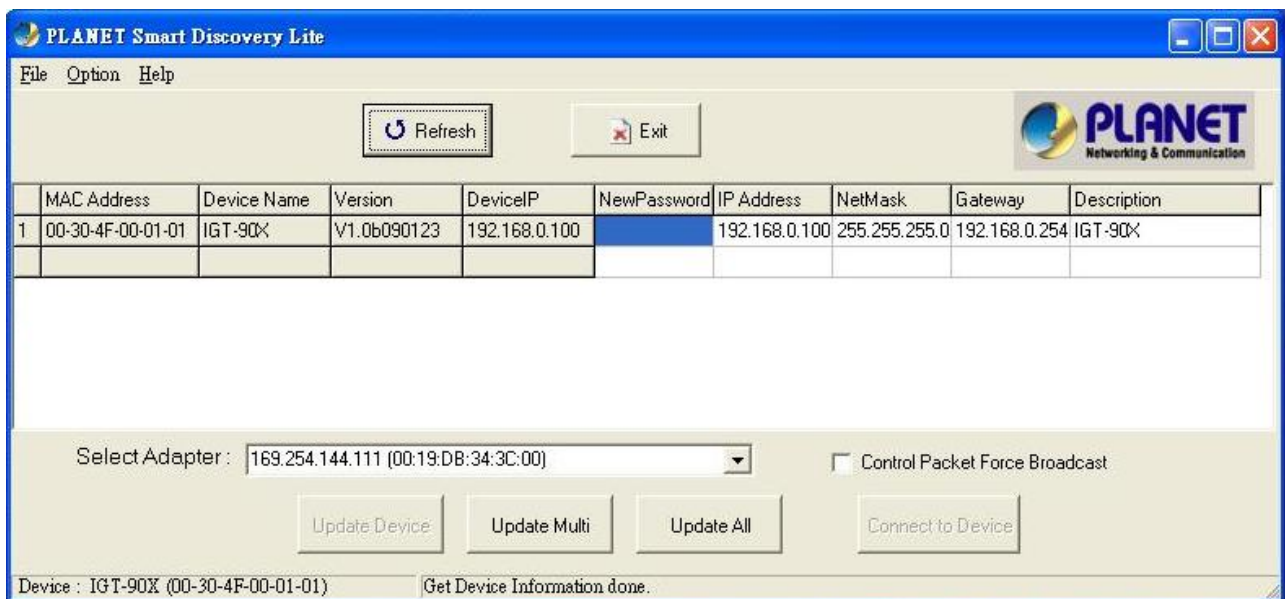

Figure 3-4 Planet Smart Discovery Utility Screen

1. This utility show all necessary information from the devices, such as MAC Address, Device Name, firmware version, Device IP Subnet address, also can assign new password, IP Subnet address and description for the devices.
2. After setup completed, press “**Update Device**”, “**Update Multi**” or “**Update All**” button to take affect. The meaning of the 3 buttons above are shown as below:
  - **Update Device**: use current setting on one single device.
  - **Update Multi**: use current setting on choose multi-devices.
  - **Update All**: use current setting on whole devices in the list.

The same functions mentioned above also can be finding in “**Option**” tools bar.

3. To click the “**Control Packet Force Broadcast**” function, it can allow assign new setting value to the Managed Media Converter under different IP subnet address.
4. Press “**Connect to Device**” button then the Web login screen appears in [Figure 3-2](#).
5. Press “**Exit**” button to shutdown the planet Smart Discovery Utility.

## 4. WEB MANAGEMENT

The IGT-90X Industrial Managed Media Converter provide remote Web interface for management function configuration and make the Industrial Managed Media Converter operate more effectively - They can be configured through the Web Browser. A network administrator can manage and monitor the Industrial Managed Media Converter from the local LAN. This section indicates how to configure the Industrial Managed Media Converter to enable its management function.

### 4.1 Main Menu

After a successful login, the main screen appears, the main screen displays the Industrial Managed Media Converter Welcome page. The screen in [Figure 4-1](#) appears.



Figure 4-1 Web Main screen

As listed at the left of the main screen, the configurable management functions are shown as below:

- ◆ **System** – Provide System configuration of Industrial Managed Media Converter. [Explained in section 4.2.](#)
- ◆ **Port Management** – Provide Port Management configuration of Industrial Managed Media Converter. [Explained in section 4.3.](#)
- ◆ **Converter Configuration** – Provide Converter configuration of Industrial Managed Media Converter. [Explained in section 4.4.](#)
- ◆ **VLAN** – Provide VLAN configuration of Industrial Managed Media Converter. [Explained in section 4.5.](#)
- ◆ **Quality of Service** – Provide Quality of Service (QoS) function of the Industrial Managed Media Converter. [Explained in section 4.6.](#)
- ◆ **OAM Setup** – Provide OAM Setup function of the Industrial Managed Media Converter. [Explained in section 4.7.](#)
- ◆ **Security** – Provide Security function of the Industrial Managed Media Converter. [Explained in section 4.8.](#)
- ◆ **Logout**– Provide Logout function of the Industrial Managed Media Converter. [Explained in section 4.9.](#)



## 4.2 System

### 4.2.1 System Information

The System Information Web page provides information for the current device. System Information Web page helps network administrator to identify the firmware versions, IP Subnet Address and etc. The screen in [Figure 4-2](#) appears and [Table 4-1](#) describes the System Information object of Industrial Managed Media Converter.

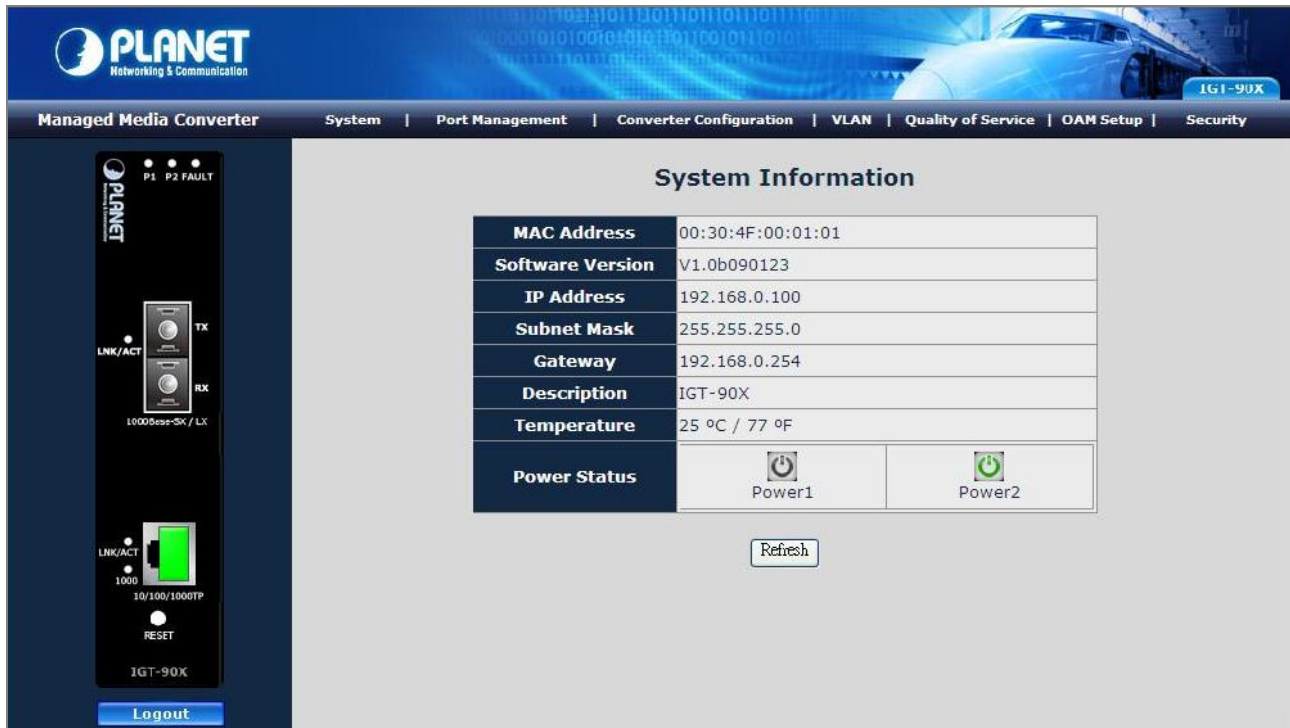

**Figure 4-2** System Information Web page screen

The System Information Web page screen includes the following fields:

<b>MAC Address</b>	Specifies the MAC address of IGT-90X.
<b>Software Version</b>	The current software version running on the IGT-90X.
<b>IP Address</b>	The current IP Address of IGT-90X, the default IP Address is <b>192.168.0.100</b> .
<b>Subnet Mask</b>	The current Subnet Mask of IGT-90X, the default Subnet Mask is <b>255.255.255.0</b> .
<b>Gateway</b>	The current gateway of IGT-90X, the factory default gateway is <b>192.168.0.254</b> .
<b>Description</b>	The current description of IGT-90X, the factory default description is IGT-90X.
<b>Temperature</b>	Display current temperature of IGT-90X in Celsius and Fahrenheit.
<b>Power Status</b>	Display current power supply status of IGT-90X.
<b>Refresh</b>	Refresh current Web page screen of IGT-90X.

**Table 4-1** Descriptions of the System Information Web Page Screen Objects

## 4.2.2 IP Configuration

The IP Configuration includes the DHCP Client, IP Address, Subnet Mask, Gateway and Description. The screen in [Figure 4-3](#) appears and [Table 4-2](#) describes the IP Configuration object of Industrial Managed Media Converter.

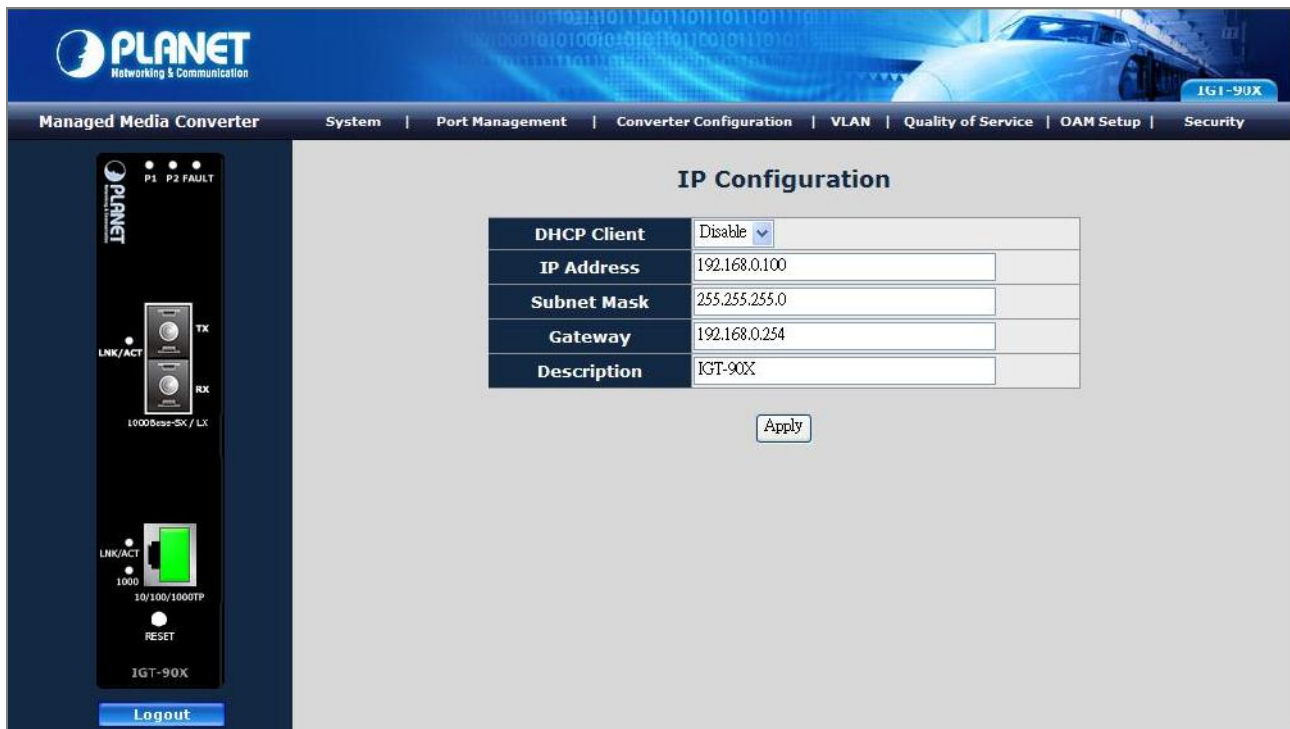

**Figure 4-3** IP Configuration Web page screen

The IP Configuration Web page screen includes the following configurable data:

<b>DHCP Client</b>	Allow disable or enable the DHCP Client function of the Industrial Managed Media Converter, the factory default mode is <b>Disable</b> .
<b>IP Address</b>	Allow assigning a new IP address for the Industrial Managed Media Converter, the factory default IP address is <b>192.168.0.100</b> .
<b>Subnet Mask</b>	Allow assigning a new subnet mask for the Industrial Managed Media Converter, the factory default subnet mask is <b>255.255.255.0</b> .
<b>Gateway</b>	Allow assigning a new gateway for the Industrial Managed Media Converter, the factory default gateway is <b>192.168.0.254</b> .
<b>Description</b>	Allow to input a new description for the Industrial Managed Media Converter, up to maximum <b>32</b> characters allow.
<b>Apply Button</b>	Press " <b>Apply</b> " button for save current configuration of Industrial Managed Media Converter.

**Table 4-2** Descriptions of the IP Configuration Web Page Screen Objects



Note

After change the default IP subnet address, if you forget the IP subnet address. Please press the "**Reset**" button in the front panel of Managed Media Converter for 10 seconds, the current setting will be lost and the Industrial Managed Media Converter will restore to factory default mode.

### 4.2.3 Password Setting

This function provides administrator to secure Web login. The screen in Figure 4-4 & 4-5 appears and Table 4-3 describes the Password Setting object of Industrial Managed Media Converter.

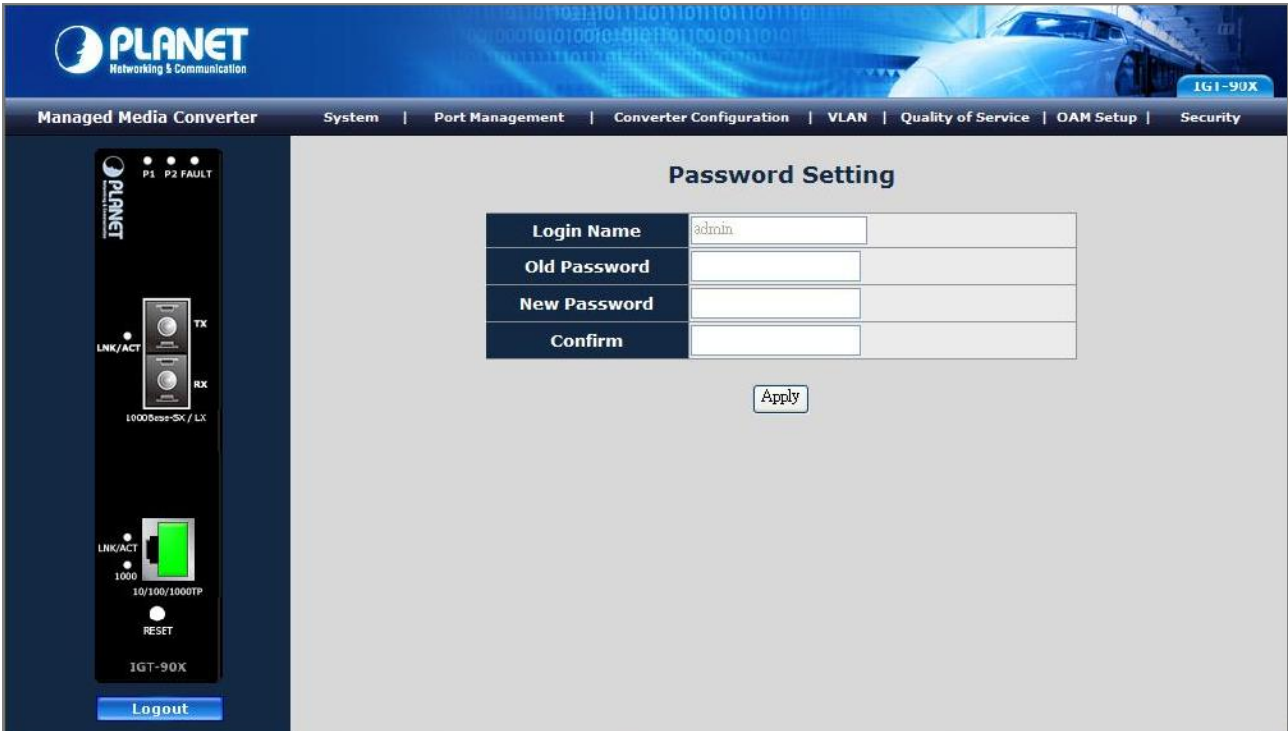

Figure 4-4 Password Setting Web page screen

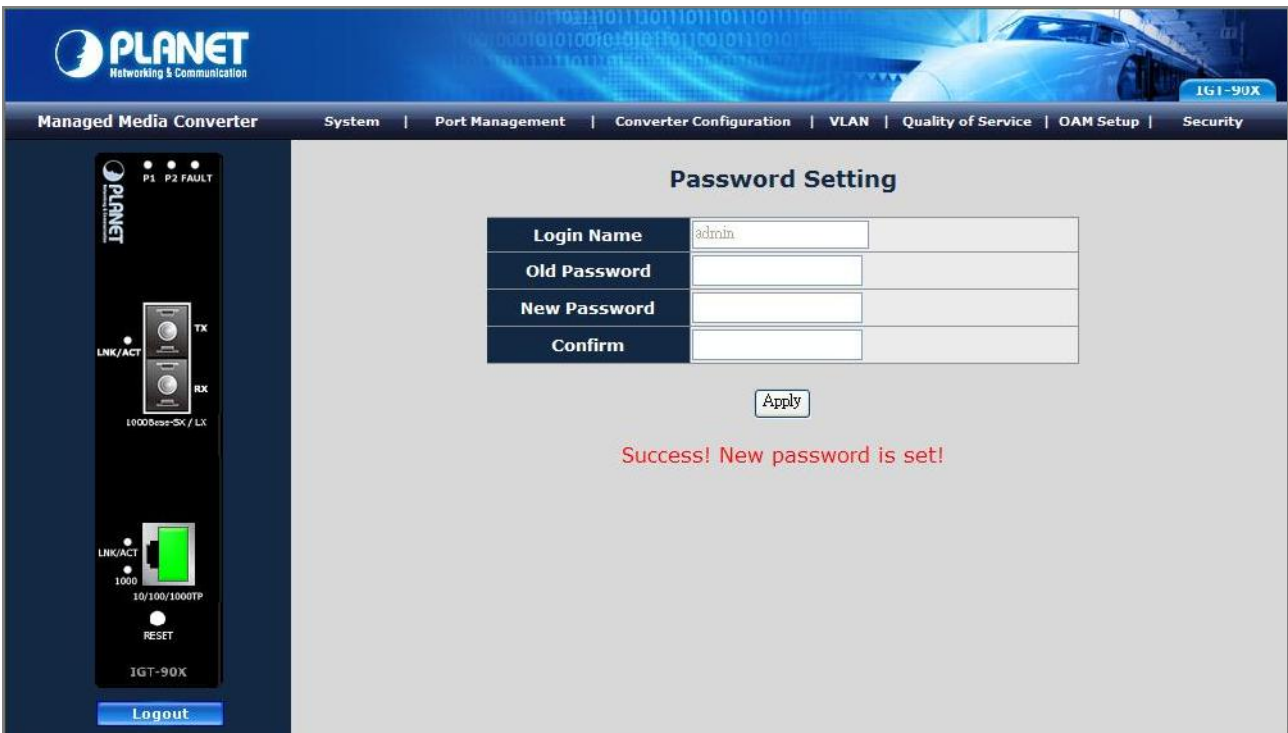

Figure 4-5 Password Setting Successful Web page screen

The Password Setting Web page includes the following configurable data:

<b>Login Name</b>	Displays the user name (admin).
<b>Old Password</b>	Enter the old password is required before entering the new password.
<b>New Password</b>	Specifies the new password. The password is not displayed. As it entered an “•” corresponding to each character is displayed in the field. (The maximum length is 16 characters)
<b>Confirm</b>	This confirms the new password. The password entered into this field must be exactly the same as the password entered in the Password field.
<b>Apply Button</b>	Press “ <b>Apply</b> ” button for save current configuration of Industrial Managed Media Converter.

**Table 4-3** Descriptions of the Password Setting Web Page Screen Objects

#### 4.2.4 Firmware Upgrade

This function provides Firmware Upgrade of the Industrial Managed Media Converter and the screen in [Figure 4-6](#) appears.

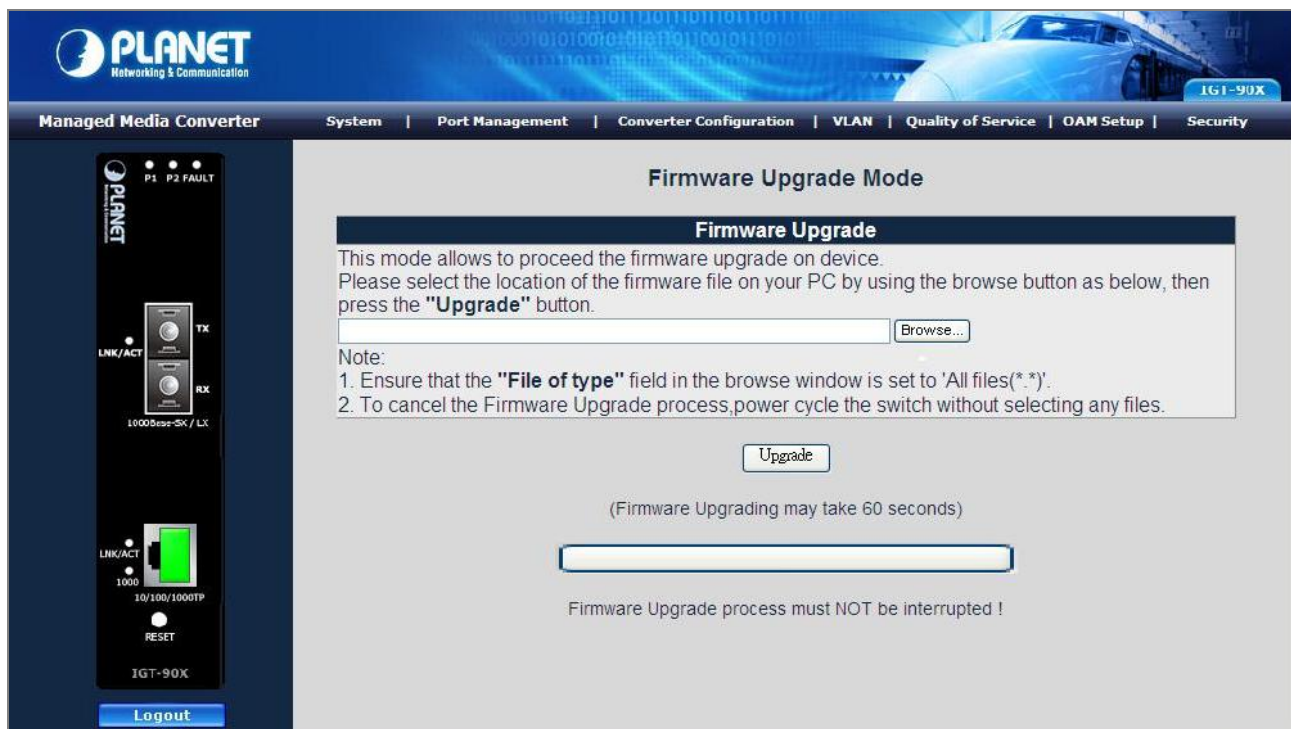

**Figure 4-6** Firmware Upgrade Web page screen

Press “**Browse**” button to find the firmware location administrator PC, The screen in [Figure 4-7](#) appears

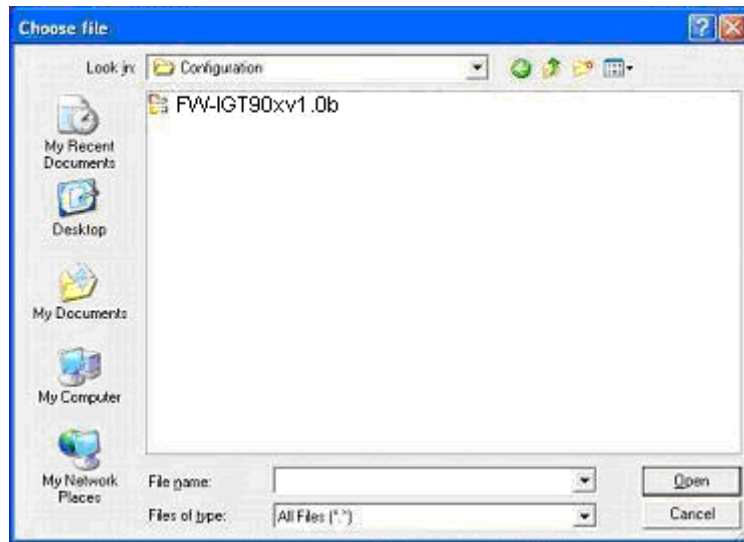

Figure 4-7 Firmware Upgrade Web page screen

After find the firmware location from administrator PC, press **“Upgrade”** button to start the firmware upgrade process. The screen in Figure 4-8 & 4-9 appears.

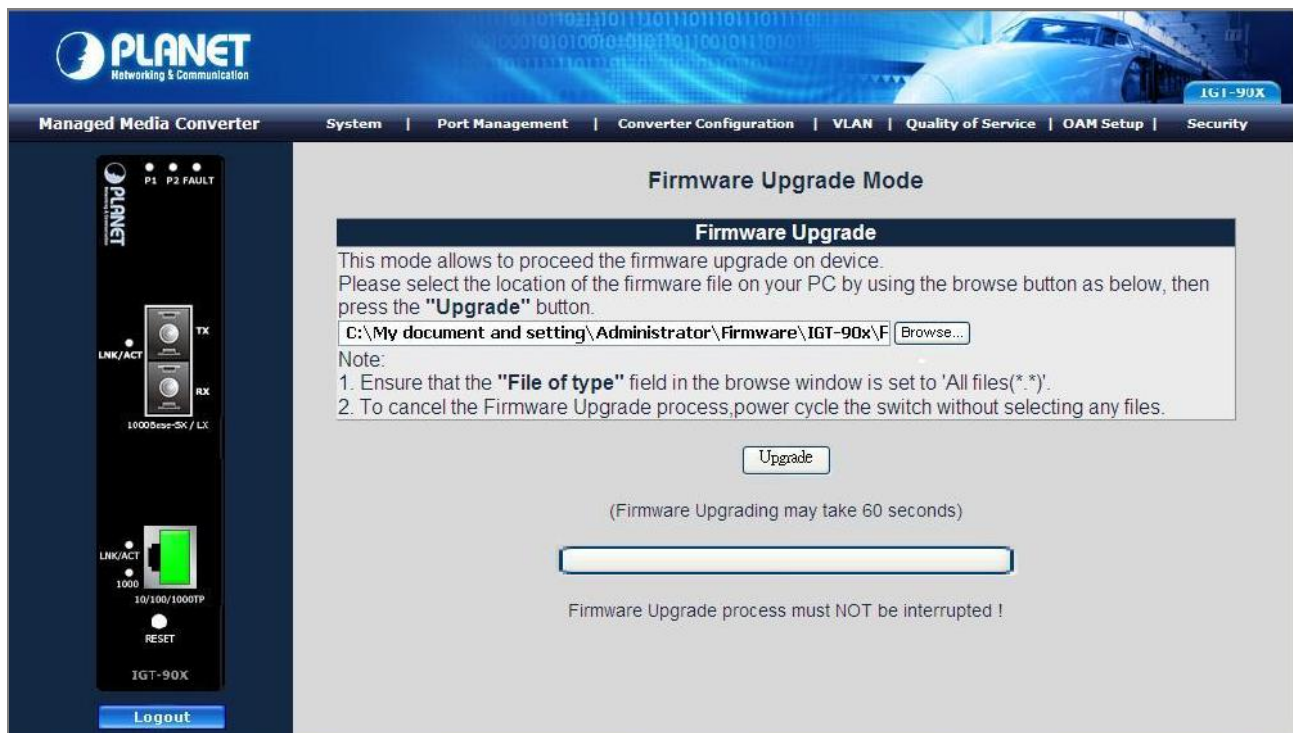

Figure 4-8 Firmware Upgrade Web page screen



Do not power off the converter until the update progress is complete.



Do not quit the Firmware Upgrade page without press the “Upgrade” button - after the image is loaded. Or the system won't apply the new firmware. Users have to repeat the firmware upgrade processes again.

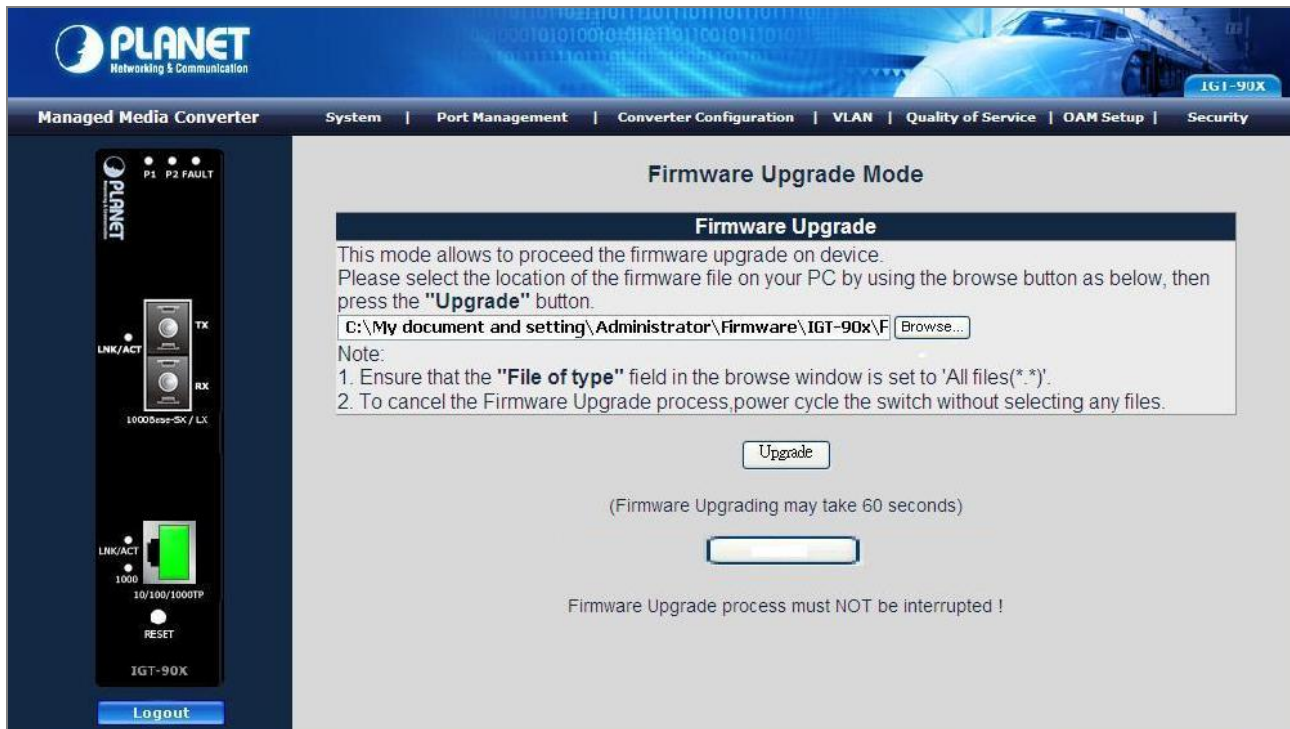

Figure 4-9 Firmware Upgrade Web page screen

When firmware upgrade process is completed then the following screen appears, please click “[here](#)” to re-login the IGT-90X with latest firmware and the screen in [Figure 4-10](#) & [4-11](#) appears.

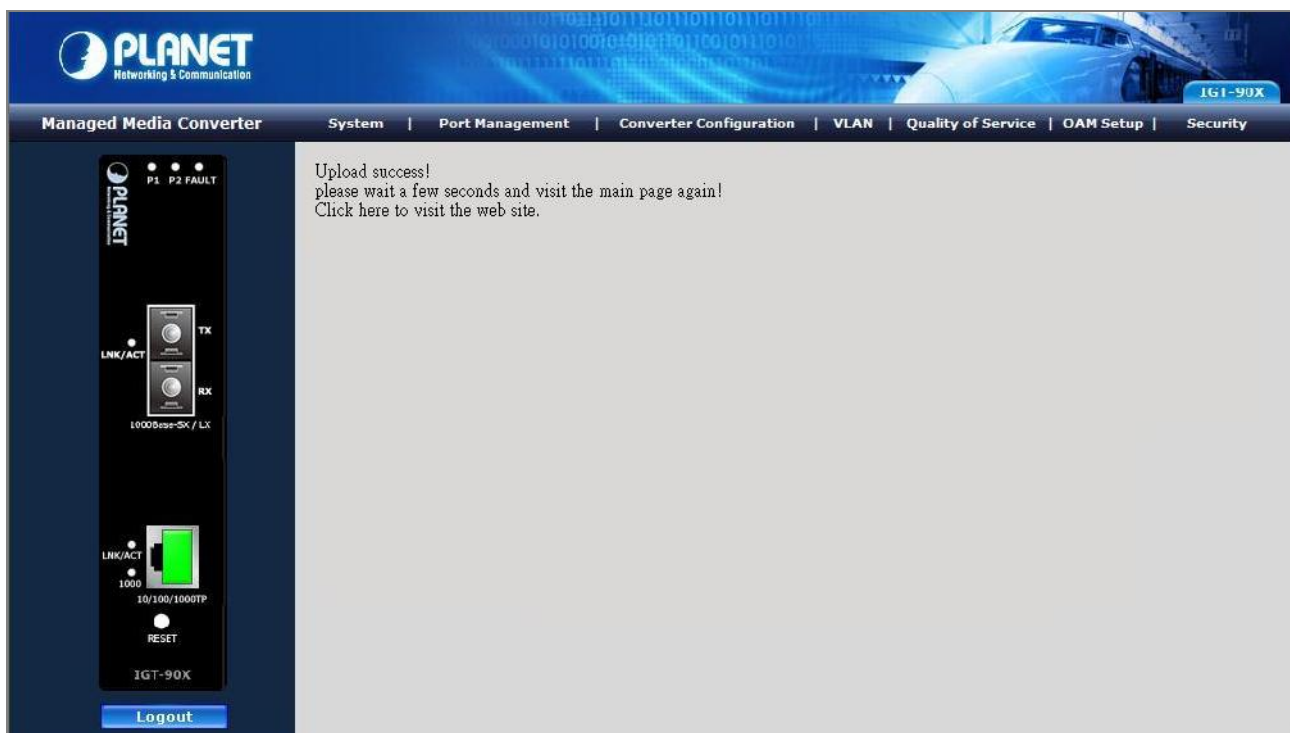
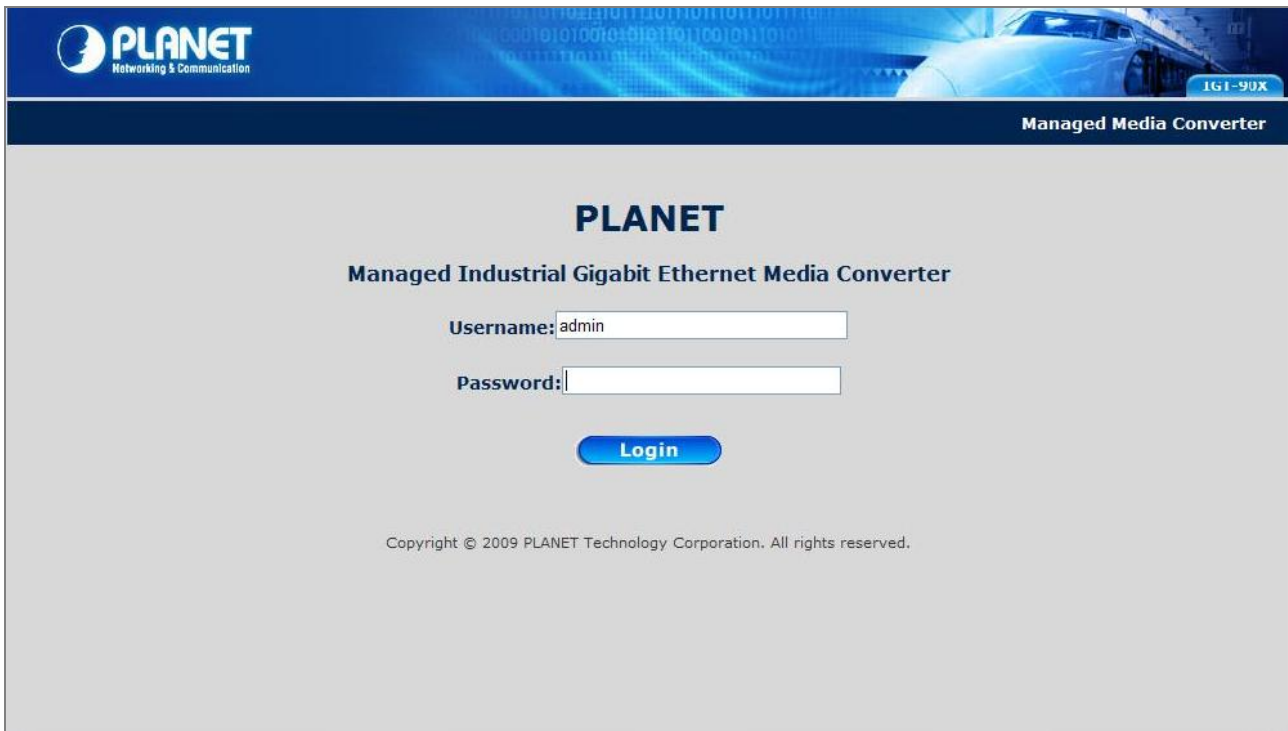

Figure 4-10 Firmware Upgrade Web page screen



**PLANET**  
Networking & Communication

Managed Media Converter

**PLANET**

Managed Industrial Gigabit Ethernet Media Converter

Username:

Password:

**Login**

Copyright © 2009 PLANET Technology Corporation. All rights reserved.

Figure 4-11 Login Web page screen

#### 4.2.5 SNMP Management

This function provides SNMP Management and SNMP Trap Receiver Configuration function of the Industrial Managed Media Converter and the screen in [Figure 4-12 & 4-13](#) appears and [Table 4-4 & 4-5](#) describes the SNMP Management and SNMP Trap Receiver object of Industrial Managed Media Converter.



SNMP Management	
SNMP Agent	Disable <input type="button" value="v"/>
SNMP Read Community	<input type="text" value="public"/>
SNMP Write Community	<input type="text" value="private"/>
System Name	<input type="text" value="IGT-90X"/>
System Location	<input type="text"/>
Contact	<input type="text"/>

Figure 4-12 SNMP Management Web page screen

The SNMP Management Web page includes the following configurable data:

<b>SNMP Agent</b>	Allow disable or enable the SNMP Agent function, the default mode is “Disable”.
<b>SNMP Read Community</b>	Allow input the characters for SNMP Read Community, up to maximum <b>16</b> characters allow.
<b>SNMP Write Community</b>	Allow input the characters for SNMP Write Community, up to maximum <b>16</b> characters allow.
<b>System Name</b>	Allow input the characters for System Name, up to maximum <b>16</b> characters allow.
<b>System Location</b>	Allow input the characters for System Location, up to maximum <b>16</b> characters allow.
<b>Contact</b>	Allow input the characters for Contact person, up to maximum <b>16</b> characters allow.
<b>Apply Button</b>	Press “ <b>Apply</b> ” button for save current configuration of IGT-90X.

**Table 4-4** Descriptions of the SNMP Management Web Page Screen Objects



The IGT-90X supports SNMP v1 / v2c protocol.

**Figure 4-13** SNMP Trap Receiver Configuration Web page screen

The SNMP Trap Receiver Configuration Web page includes the following configurable data:

<b>SNMP Trap</b>		Allow disable or enable the SNMP Trap function, the default mode is “Disable”.
<b>SNMP Trap Destination</b>		Allow input the IP address of SNMP Trap Destination.
<b>Trap Event</b>	<b>Cold Start</b>	When IGT-90X executes Cold Start operation, the administrator PC (SNMP Trap Destination) will receive a Cold Start Trap.
	<b>Warm Start</b>	When IGT-90X executes Warm Start operation, the administrator PC (SNMP Trap Destination) will receive a Warm Start Trap.
	<b>Login Fail</b>	When Web login fail situation appears on IGT-90X, the administrator PC (SNMP Trap Destination) will receive a Login Fail Trap.



	<b>Link Up</b>	When TP or Fiber port connection is build up, the administrator PC (SNMP Trap Destination) will receive a Link Up Trap.
	<b>Link Down</b>	When TP or Fiber port connection is Disconnect, the administrator PC (SNMP Trap Destination) will receive a Link Down Trap.
<b>Apply Button</b>		Press " <b>Apply</b> " button for save current configuration of IGT-90X

**Table 4-5** Descriptions of the SNMP Trap Receiver Configuration Web Page Screen Objects

#### 4.2.6 Factory Default

This function provides Factory Default function of the Industrial Managed Media Converter and the screen in [Figure 4-14](#) & [4-15](#) & [4-16](#) appears.

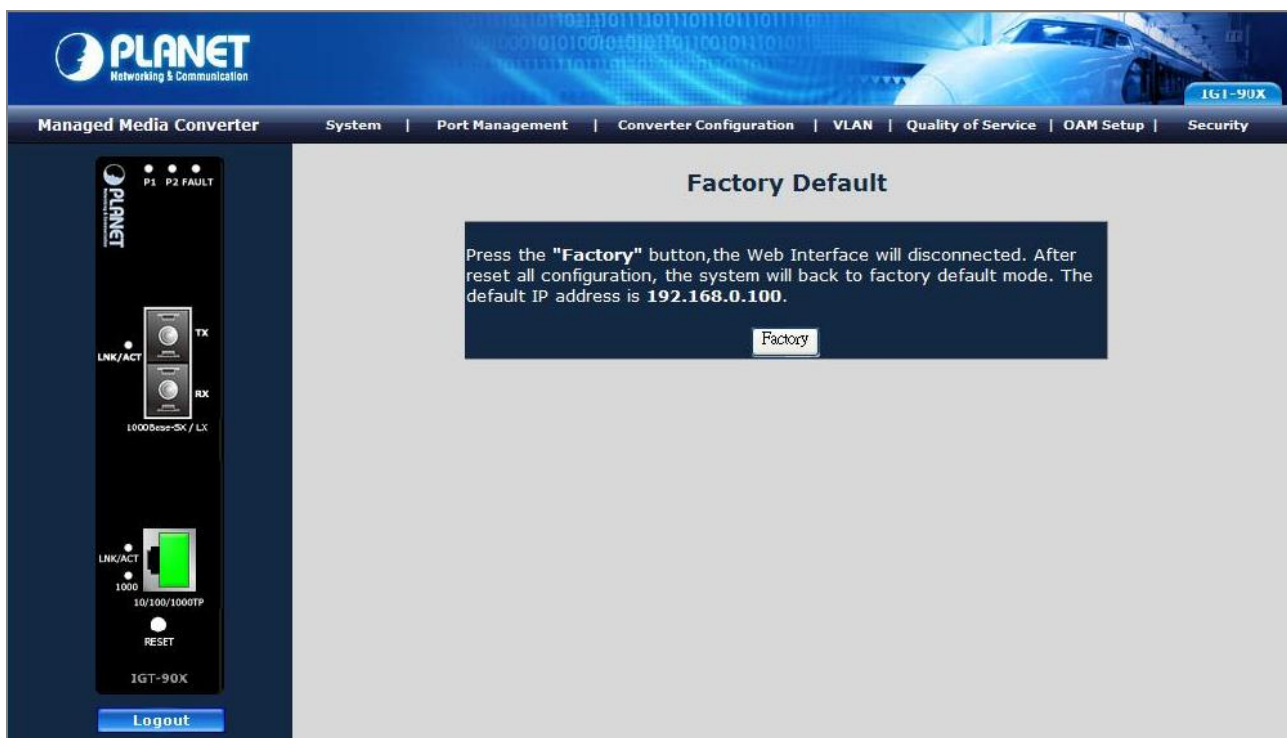

**Figure 4-14** Factory Default Web page screen

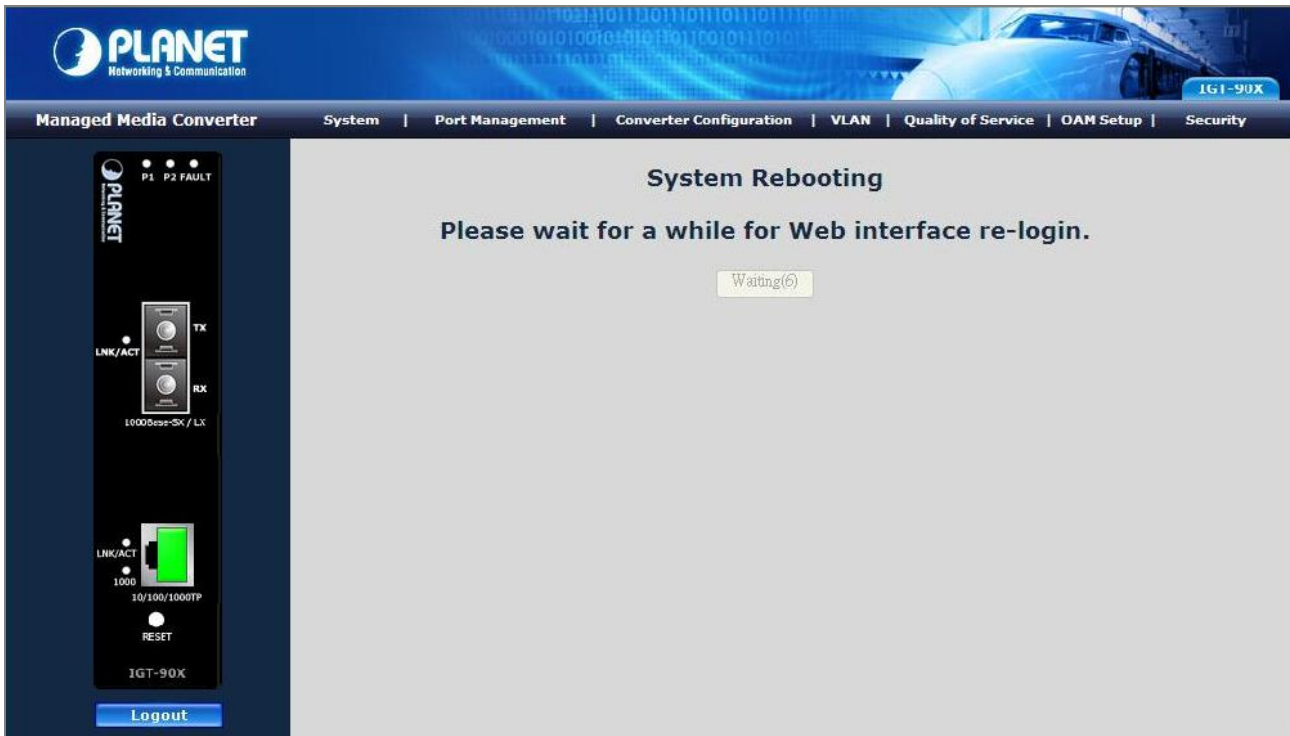

Figure 4-15 Factory Default Web page screen

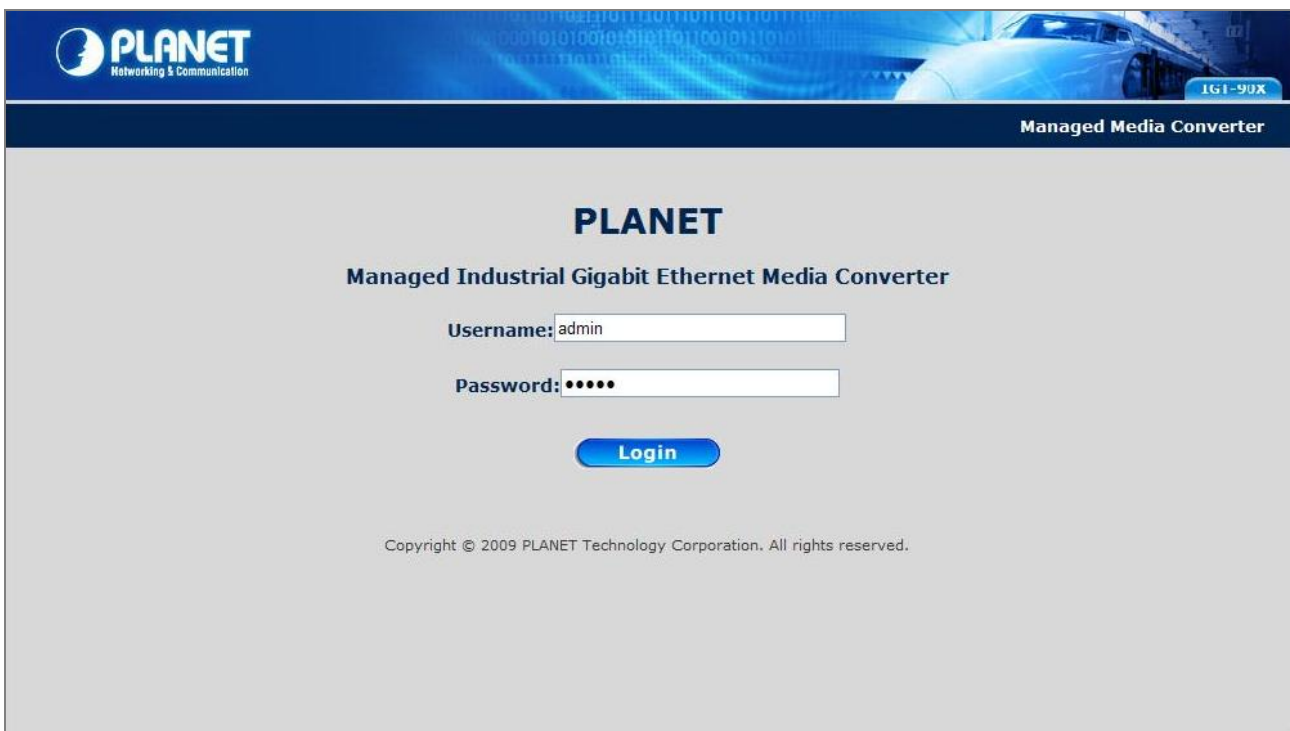

Figure 4-16 Login Web page screen

## 4.2.7 System Reboot

This function provides System Reboot function of the Industrial Managed Media Converter and the screen in [Figure 4-17](#) & [4-18](#) & [4-19](#) appears.

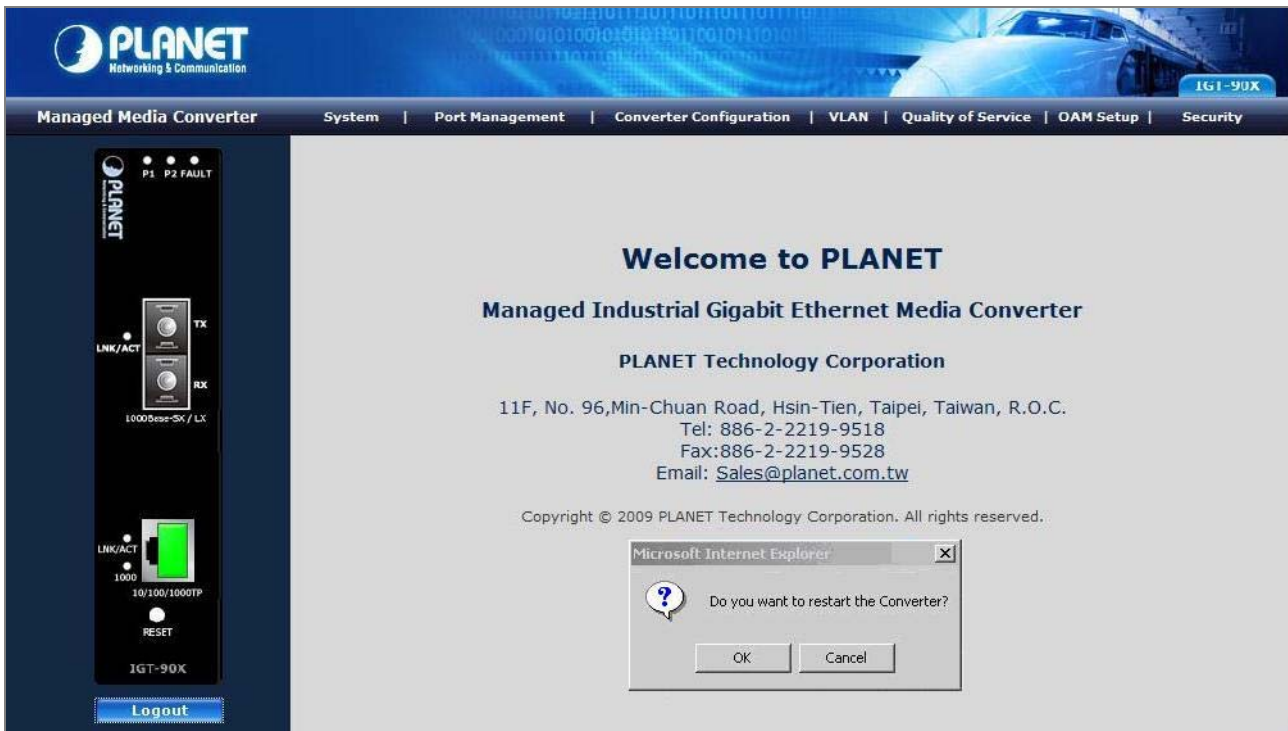

Figure 4-17 System Reboot Web page screen



Figure 4-18 System Reboot Web page screen

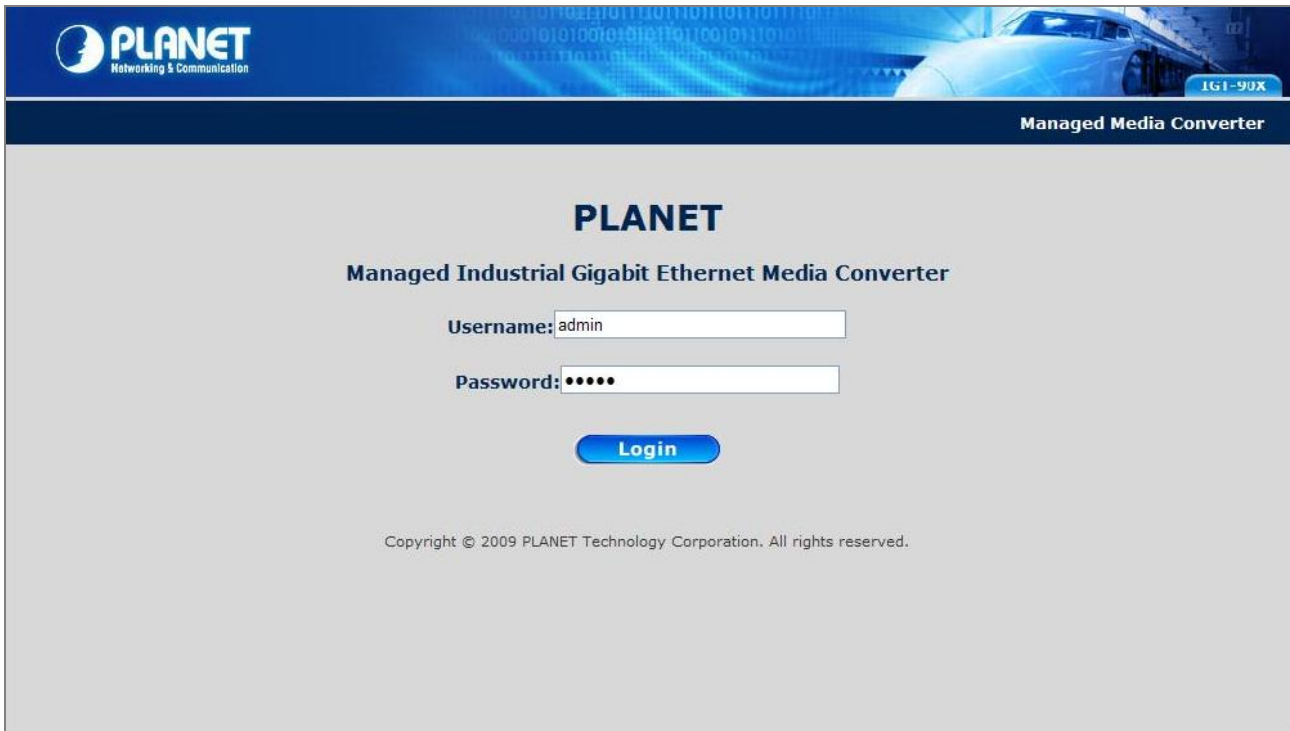

Figure 4-19 Login Web page screen

## 4.3 Port Management

### 4.3.1 Port Configuration

This function allows displaying TP / Fiber port status. The Link Status in the screen displays the current connection speed and duplex mode; else this function will show red "Down" when the TP / Fiber port is disconnected. Press the "Refresh" button to renew the screen. The screen in Figure 4-20 appears and Table 4-6 describes the Port Configuration object of IGT-90X.

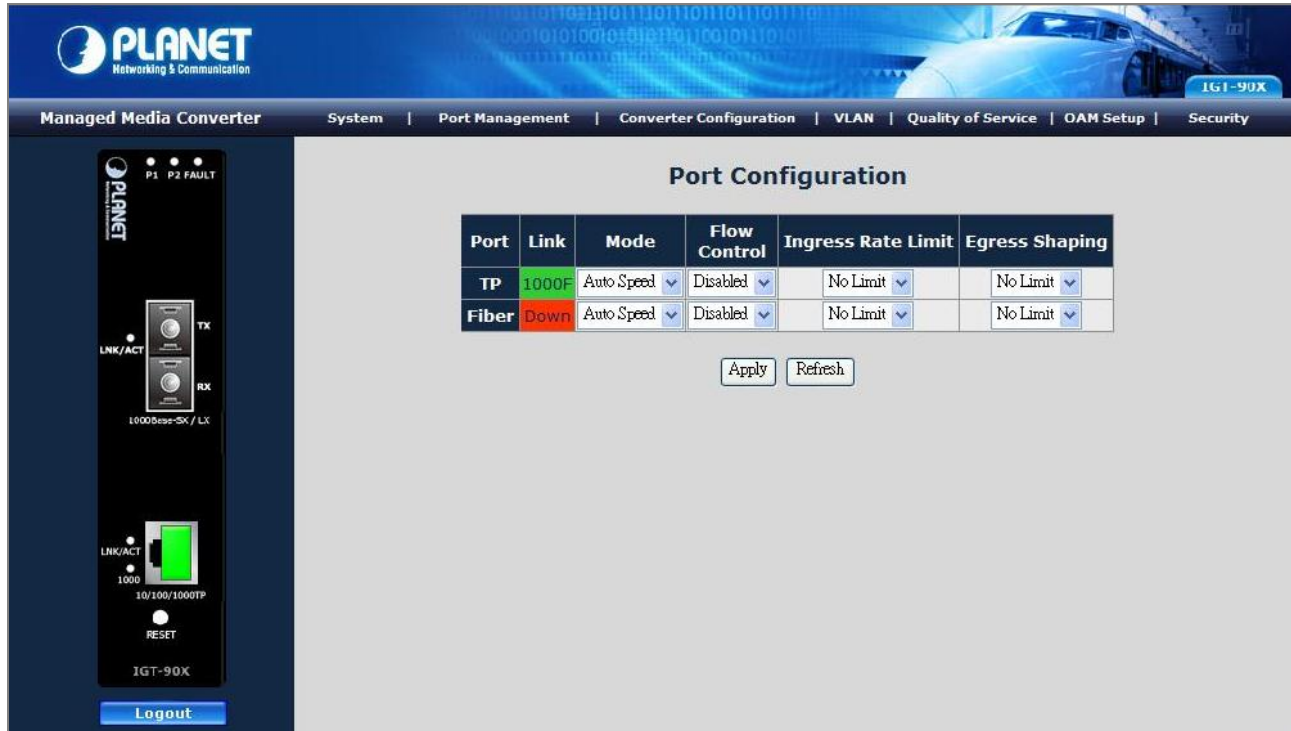

Figure 4-20 Port Configuration Web Page screen

The Port Configuration Web page includes the following configurable data:

<b>Port</b>	Indicate the TP port and Fiber port.																
<b>Link</b>	Displays the current connection speed and duplex mode of TP or Fiber port.																
<b>Mode</b>	<p>Allow configuring the TP or Fiber port speed and operation mode. Draw the menu bar to select the mode.</p> <p><b>TP Port:</b></p> <table border="1"> <tr> <td>• <b>Auto Speed</b></td> <td>Setup Auto negotiation</td> </tr> <tr> <td>• <b>1000 Full</b></td> <td>Force sets 1000Mbps Full-Duplex mode</td> </tr> <tr> <td>• <b>100 Full</b></td> <td>Force sets 100Mbps Full-Duplex mode</td> </tr> <tr> <td>• <b>100 Half</b></td> <td>Force sets 100Mbps Half-Duplex mode</td> </tr> <tr> <td>• <b>10 Full</b></td> <td>Force sets 10Mbps Full-Duplex mode</td> </tr> <tr> <td>• <b>10 Half</b></td> <td>Force sets 10Mbps Half-Duplex mode</td> </tr> </table> <p>Default mode: <b>Auto Speed</b>.</p> <p><b>Fiber Port:</b></p> <table border="1"> <tr> <td>• <b>Auto Speed</b></td> <td>Setup Auto negotiation</td> </tr> <tr> <td>• <b>1000 Full</b></td> <td>Force sets 1000Mbps Full-Duplex mode</td> </tr> </table> <p>Default mode: <b>Auto Speed</b>.</p>	• <b>Auto Speed</b>	Setup Auto negotiation	• <b>1000 Full</b>	Force sets 1000Mbps Full-Duplex mode	• <b>100 Full</b>	Force sets 100Mbps Full-Duplex mode	• <b>100 Half</b>	Force sets 100Mbps Half-Duplex mode	• <b>10 Full</b>	Force sets 10Mbps Full-Duplex mode	• <b>10 Half</b>	Force sets 10Mbps Half-Duplex mode	• <b>Auto Speed</b>	Setup Auto negotiation	• <b>1000 Full</b>	Force sets 1000Mbps Full-Duplex mode
• <b>Auto Speed</b>	Setup Auto negotiation																
• <b>1000 Full</b>	Force sets 1000Mbps Full-Duplex mode																
• <b>100 Full</b>	Force sets 100Mbps Full-Duplex mode																
• <b>100 Half</b>	Force sets 100Mbps Half-Duplex mode																
• <b>10 Full</b>	Force sets 10Mbps Full-Duplex mode																
• <b>10 Half</b>	Force sets 10Mbps Half-Duplex mode																
• <b>Auto Speed</b>	Setup Auto negotiation																
• <b>1000 Full</b>	Force sets 1000Mbps Full-Duplex mode																
<b>Flow Control</b>	<p>Allow <b>Disable</b> or <b>Enable</b> Flow Control of TP or Fiber port.</p> <p><b>Enable:</b> IEEE 802.3x Flow Control is enabled on Full-Duplex mode or Backpressure is enabled on Half-Duplex mode</p>																

	<p><b>Disable:</b> No Flow Control or backpressure function on no matter Full-Duplex or Half-Duplex mode</p> <p>Default mode: <b>Disable</b></p>
<b>Ingress Rate Limit</b>	<p>The value of inbound traffic limitation in kilobit-per-second (kbps). The available options are :</p> <ul style="list-style-type: none"> <li>• <b>No Limit</b></li> <li>• <b>512K</b></li> <li>• <b>1M</b></li> <li>• <b>2M</b></li> <li>• <b>4M</b></li> <li>• <b>8M</b></li> <li>• <b>10M</b></li> <li>• <b>50M</b></li> <li>• <b>100M</b></li> <li>• <b>500M</b></li> </ul> <p>Default mode: <b>No Limit</b></p> <p>The Ingress Rate Limit configuration field as show in <a href="#">Figure 4-21</a>.</p>
<b>Egress Shaping</b>	<p>The value of outbound traffic limitation in kilobit-per-second (kbps). The available options are :</p> <ul style="list-style-type: none"> <li>• <b>No Limit</b></li> <li>• <b>512K</b></li> <li>• <b>1M</b></li> <li>• <b>2M</b></li> <li>• <b>4M</b></li> <li>• <b>8M</b></li> <li>• <b>10M</b></li> <li>• <b>50M</b></li> <li>• <b>100M</b></li> <li>• <b>500M</b></li> </ul> <p>Default mode: <b>No Limit</b></p> <p>The Egress Shaping configuration field as show in <a href="#">Figure 4-22</a>.</p>
<b>Apply Button</b>	<p>Press this button for save current configuration of Industrial Managed Media Converter.</p>
<b>Refresh Button</b>	<p>Press "<b>Refresh</b>" button to refresh current status.</p>

**Table 4-6** Descriptions of the Port Configuration Web Page Screen Objects

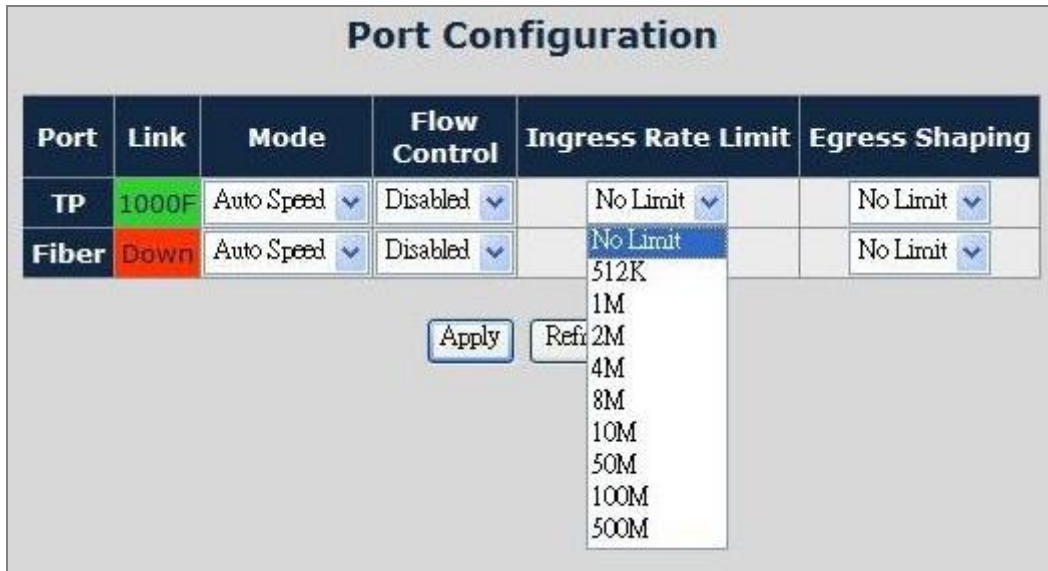

Figure 4-21 Port Configuration-Ingress Rate Limit Web Page screen

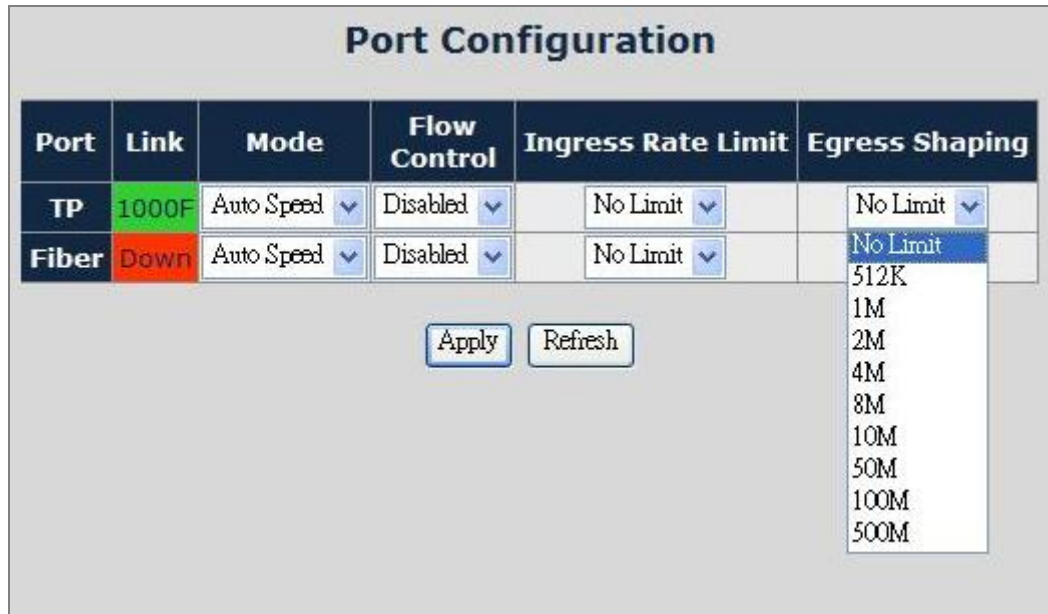

Figure 4-22 Port Configuration-Egress Shaping Web Page screen

### 4.3.2 Port Status

This function allows displaying TP / Fiber port detail status, such as Link Status, Duplex Mode, Flow control, Speed and Auto negotiation. Press the “Refresh” button to renew the screen, the screen in [Figure 4-23](#) appears and [Table 4-7](#) describes the Port Status object of Industrial Managed Media Converter.



**Figure 4-23** Port Status Web Page screen

The Port Status Web page includes the following configurable data:

<b>Port</b>	Indicate the TP port and Fiber port.
<b>Link Status</b>	Displays the current link status of TP and Fiber port.
<b>Duplex Mode</b>	Displays the current duplex mode of TP and Fiber port.
<b>Flow Control</b>	Displays the current Flow Control status of TP and Fiber port.
<b>Speed</b>	Displays the current speed mode of TP and Fiber port.
<b>Auto Negotiation</b>	Displays the current Auto negotiation status of TP and Fiber port.
<b>Refresh Button</b>	Press “Refresh” button to refresh current status.

**Table 4-7** Descriptions of the Port Status Web Page Screen Objects



### 4.3.3 Port Statistics

This function allows displaying TP / Fiber port detail statistics, press the “Clear” button to clear current counter information. Press the “Refresh” button to renew the screen, the screen in Figure 4-24 appears.



Figure 4-24 Port Statistics Web Page screen

## 4.4 Converter Configuration

This function provides useful setting for the IGT-90X as Maximum Packet length, Loop detection, storm control and etc. The screen in [Figure 4-25](#) appears and [Table 4-8](#) describes the Converter Configuration object of Industrial Managed Media Converter.



**Figure 4-25** Converter Configuration Web Page screen

The Converter Configuration Web page includes the following configurable data:

<b>Maximum Packet Length</b>	Provide maximum packet lengths setting for the IGT-90X, the available options are 1518 bytes, 2048 bytes and 16K bytes. Default mode is <b>16K bytes</b> .
<b>Loop Detection</b>	Provide Disable or enable the Loop detection function. Default mode is <b>Disable</b> .
<b>Loop Status</b>	Displays the Loop Detection status.
<b>Broadcast Storm Control</b>	Provide Disable or enable the Broadcast Storm Control function. Default mode is <b>Disable</b> .
<b>Multicast Storm Control</b>	Provide Disable or enable the Multicast Storm Control function. Default mode is <b>Disable</b> .
<b>Unicast Storm Control</b>	Provide Disable or enable the Unicast Storm Control function. Default mode is <b>Disable</b> .
<b>Storm Trigger Counter</b>	Provide storm Trigger Counter setting and the available options are: <b>64 broadcast</b> <b>32 broadcast</b> <b>16 broadcast</b> <b>8 broadcast</b> Default mode is <b>64 broadcast</b> .
<b>Storm Filter Timer</b>	Provide storm Filter Timer setting and the available options are: <b>800ms</b> <b>400ms</b>

	<b>200ms</b> <b>100ms</b> Default mode is <b>800ms</b> .
<b>Apply Button</b>	Press this button for save current configuration of Managed Media Converter.

**Table 4-8** Descriptions of the Converter Configuration Web Page Screen Objects

## 4.5 VLAN

A Virtual LAN (VLAN) is a logical network grouping that limits the broadcast domain. It allows you to isolate network traffic so only members of the VLAN receive traffic from the same VLAN members. Basically, creating a VLAN from a converter is logically equivalent of reconnecting a group of network devices to another Layer 2 switch. However, all the network devices are still plug into the same switch physically.

The Industrial Managed Media Converter supports IEEE 802.1Q (tagged-based) VLAN setting in web management page. In the default configuration, VLAN support is “**No VLAN**”.

### IEEE 802.1Q VLANs

IEEE 802.1Q (tagged) VLAN are implemented on the Industrial Managed Media Converter. 802.1Q VLAN require tagging, which enables them to span the entire network (assuming all devices on the network are IEEE 802.1Q-compliant).

VLAN allow a network to be segmented in order to reduce the size of broadcast domains. All packets entering a VLAN will only be forwarded to the stations (over IEEE 802.1Q enabled switches) that are members of that VLAN, and this includes broadcast, multicast and unicast packets from unknown sources.

VLAN can also provide a level of security to your network. IEEE 802.1Q VLAN will only deliver packets between stations that are members of the VLAN. Any port can be configured as either tagging or untagging. The untagging feature of IEEE 802.1Q VLAN allows VLAN to work with legacy switches that don't recognize VLAN tags in packet headers. The tagging feature allows VLAN to span multiple 802.1Q-compliant switches through a single physical connection and allows Spanning Tree to be enabled on all ports and work normally.

Any port can be configured as either tagging or untagging. The untagging feature of IEEE 802.1Q VLAN allows VLAN to work with legacy switches that don't recognize VLAN tags in packet headers. The tagging feature allows VLAN to span multiple 802.1Q-compliant switches through a single physical connection and allows Spanning Tree to be enabled on all ports and work normally.

Some relevant terms:

**Tag** - The act of putting 802.1Q VLAN information into the header of a packet.

**Untag** - The act of stripping 802.1Q VLAN information out of the packet header.

### 802.1Q VLAN Tags

The figure below shows the 802.1Q VLAN tag. There are four additional octets inserted after the source MAC address. Their presence is indicated by a value of 0x8100 in the Ether Type field. When a packet's Ether Type field is equal to 0x8100, the packet carries the IEEE 802.1Q/802.1p tag. The tag is contained in the following two octets and consists of 3 bits of user priority, 1 bit of Canonical Format Identifier (CFI - used for encapsulating Token Ring packets so they can be carried across Ethernet backbones), and 12 bits of VLAN ID (VID). The 3 bits of user priority are used by 802.1p. The VID is the VLAN identifier and is used by the 802.1Q standard. Because the VID is 12 bits long, 4094 unique VLAN can be identified.

The tag is inserted into the packet header making the entire packet longer by 4 octets. All of the information originally contained in the packet is retained.

**802.1Q Tag**

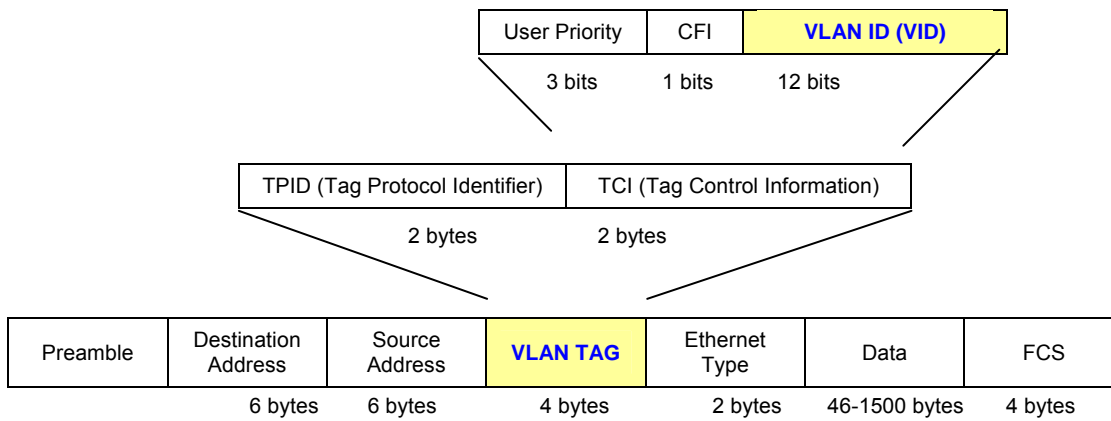

The Ether Type and VLAN ID are inserted after the MAC source address, but before the original Ether Type/Length or Logical Link Control. Because the packet is now a bit longer than it was originally, the Cyclic Redundancy Check (CRC) must be recalculated.

**Adding an IEEE802.1Q Tag**

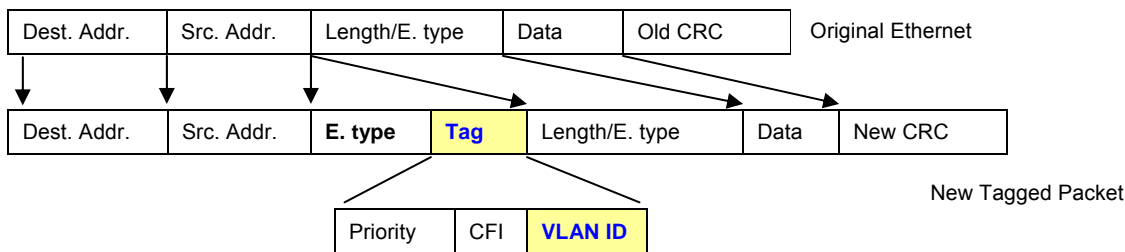

**Port VLAN ID**

Packets that are tagged (are carrying the 802.1Q VID information) can be transmitted from one 802.1Q compliant network device to another with the VLAN information intact. This allows 802.1Q VLAN to span network devices (and indeed, the entire network – if all network devices are 802.1Q compliant).

Every physical port on a switch has a PVID. 802.1Q ports are also assigned a PVID, for use within the switch. If no VLAN are defined on the switch, all ports are then assigned to a default VLAN with a PVID equal to 1. Untagged packets are assigned the PVID of the port on which they were received. Forwarding decisions are based upon this PVID, in so far as VLAN are concerned. Tagged packets are forwarded according to the VID contained within the tag. Tagged packets are also assigned a PVID, but the PVID is not used to make packet forwarding decisions, the VID is.

Tag-aware switches must keep a table to relate PVID within the switch to VID on the network. The switch will compare the VID of a packet to be transmitted to the VID of the port that is to transmit the packet. If the two VID are different the switch will drop the packet. Because of the existence of the PVID for untagged packets and the VID for tagged packets, tag-aware and tag-unaware network devices can coexist on the same network.

A switch port can have only one PVID, but can have as many VID as the switch has memory in its VLAN table to store them.

Because some devices on a network may be tag-unaware, a decision must be made at each port on a tag-aware device before packets are transmitted – should the packet to be transmitted have a tag or not? If the transmitting port is connected to a tag-unaware device, the packet should be untagged. If the transmitting port is connected to a tag-aware device, the packet should be tagged.

## Default VLANs

The Industrial Managed Media Converter initially configures one VLAN, VID = 1, called "**default**." The factory default setting assigns all ports on the Industrial Managed Media Converter to the "**default**". As new VLAN are configured in Port-based mode, their respective member ports are removed from the "**default**."

### 4.5.1 VLAN Group

This function allows disable or enable the IEEE 802.1Q VLAN operation mode. Press the "**Apply**" button to save the current configuration of Industrial Managed Media Converter. The screen in [Figure 4-26 & 4-27](#) appears and [Table 4-9](#) describes the VLAN Group object of Industrial Managed Media Converter.



Figure 4-26 VLAN Group Web Page screen

**802.1Q VLAN Group**

VLAN Mode: Enable

Management VLAN Group: 1

VLAN Group	VID	Member	
		TP	Fiber
1	1	<input checked="" type="checkbox"/>	<input checked="" type="checkbox"/>
2	2	<input type="checkbox"/>	<input type="checkbox"/>
3	3	<input type="checkbox"/>	<input type="checkbox"/>
4	4	<input type="checkbox"/>	<input type="checkbox"/>
5	5	<input type="checkbox"/>	<input type="checkbox"/>
6	6	<input type="checkbox"/>	<input type="checkbox"/>
7	7	<input type="checkbox"/>	<input type="checkbox"/>
8	8	<input type="checkbox"/>	<input type="checkbox"/>
9	9	<input type="checkbox"/>	<input type="checkbox"/>
10	10	<input type="checkbox"/>	<input type="checkbox"/>
11	11	<input type="checkbox"/>	<input type="checkbox"/>
12	12	<input type="checkbox"/>	<input type="checkbox"/>
13	13	<input type="checkbox"/>	<input type="checkbox"/>
14	14	<input type="checkbox"/>	<input type="checkbox"/>
15	15	<input type="checkbox"/>	<input type="checkbox"/>
16	16	<input type="checkbox"/>	<input type="checkbox"/>

Apply

Figure 4-27 VLAN Group Web Page screen

The VLAN Group Web page includes the following configurable data:

<b>VLAN Mode</b>	Provide Disable or enable the IEEE 802.1Q VLAN operation mode. Default mode is <b>Disable</b> .	
<b>Management VLAN Group</b>	Provide define the Management VLAN group. Default mode is <b>VLAN1</b> .	
<b>VLAN Group</b>	Indicate the VLAN Group from 1 to 16.	
<b>VID</b>	Provide define the VLAN Group ID and the available options are <b>1 to 4094</b> .	
<b>Member</b>	<b>TP</b>	Provide assign TP port into VLAN Groups.
	<b>Fiber</b>	Provide assign Fiber port into VLAN Groups.
<b>Apply Button</b>	Press this button for save current configuration of Industrial Managed Media Converter.	

Table 4-9 Descriptions of the VLAN Group Web Page Screen Objects



Note

When change the Management VLAN Group setting, please assure the TP or fiber port that connect to administrator PC is in the same VLAN Group, otherwise, for further managed is impossible. The only solution is press the reset button 10 seconds for system reset to default mode.

## 4.5.2 VLAN Per Port Setting

This function provides IEEE 802.1Q VLAN per port setting for TP and Fiber port of IGT-90X. Press the “**Apply**” button to save the current configuration of IGT-90X. The screen in [Figure 4-28](#) appears and [Table 4-10](#) describes the VLAN Per Port Setting object of Industrial Managed Media Converter.

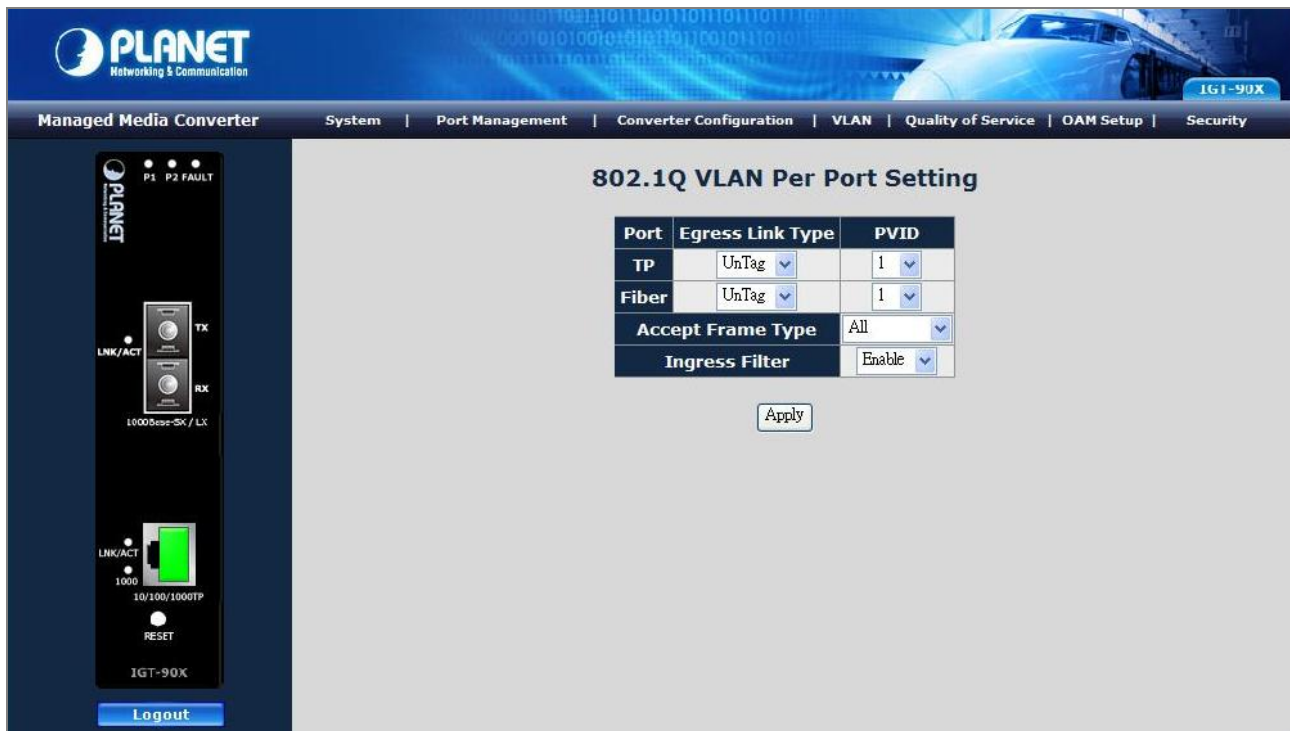

**Figure 4-28** VLAN Per Port Setting Web Page screen

The VLAN Per Port Setting Web page includes the following configurable data:

<b>Port</b>	Indicate the TP port and Fiber port.
<b>Egress Link Type</b>	Provide Egress Link Type options for TP port and Fiber port, the available options are: <ul style="list-style-type: none"> <li>• <b>UnTag</b></li> <li>• <b>Tag</b></li> <li>• <b>ByPass</b></li> </ul> Default mode is <b>UnTag</b> .
<b>PVID</b>	Provide PVID assign for TP port and Fiber port, the available options are 1 to 4094. Default mode is <b>1 to 16</b> .
<b>Accept Frame Type</b>	Provide define the Accept Frame Type and the available options are <ul style="list-style-type: none"> <li>• <b>All</b></li> <li>• <b>Tagged Only</b></li> </ul> Default mode is <b>All</b> .
<b>Ingress Filter</b>	Provide disable or enable the Ingress Filter function. Default mode is <b>Enable</b> .
<b>Apply Button</b>	Press this button for save current configuration of Industrial Managed Media Converter.

**Table 4-10** Descriptions of the VLAN Per Port Setting Web Page Screen Objects

### 4.5.3 Q-in-Q VLAN Setting

When enable Q-in-Q function, IGT-90X can insert or remove 4-bytes Q-in-Q tag in the received 802.3 frames after SA. User can define Q-in-Q tag value freely. And in default condition, Q-in-Q tag format is same as VLAN tag. In normal application, enable two port's Q-in-Q function. UTP Port set to insert Q-in-Q tag and Fiber port set to remove Q-in-Q Tag. For aggregation layer switch, it will check Q-in-Q tag only, not care about the VLAN tag from the corridor layer switch. Q-in-Q Tag ether type can be set same as VLAN tag ether type or other values.

This function provides IEEE 802.1Q Q-in-Q VLAN setting of IGT-90X. Press the “**Apply**” button to save the current configuration. The screen in [Figure 4-29](#) appears and [Table 4-11](#) describes the Q-in-Q VLAN setting object of IGT-90X.

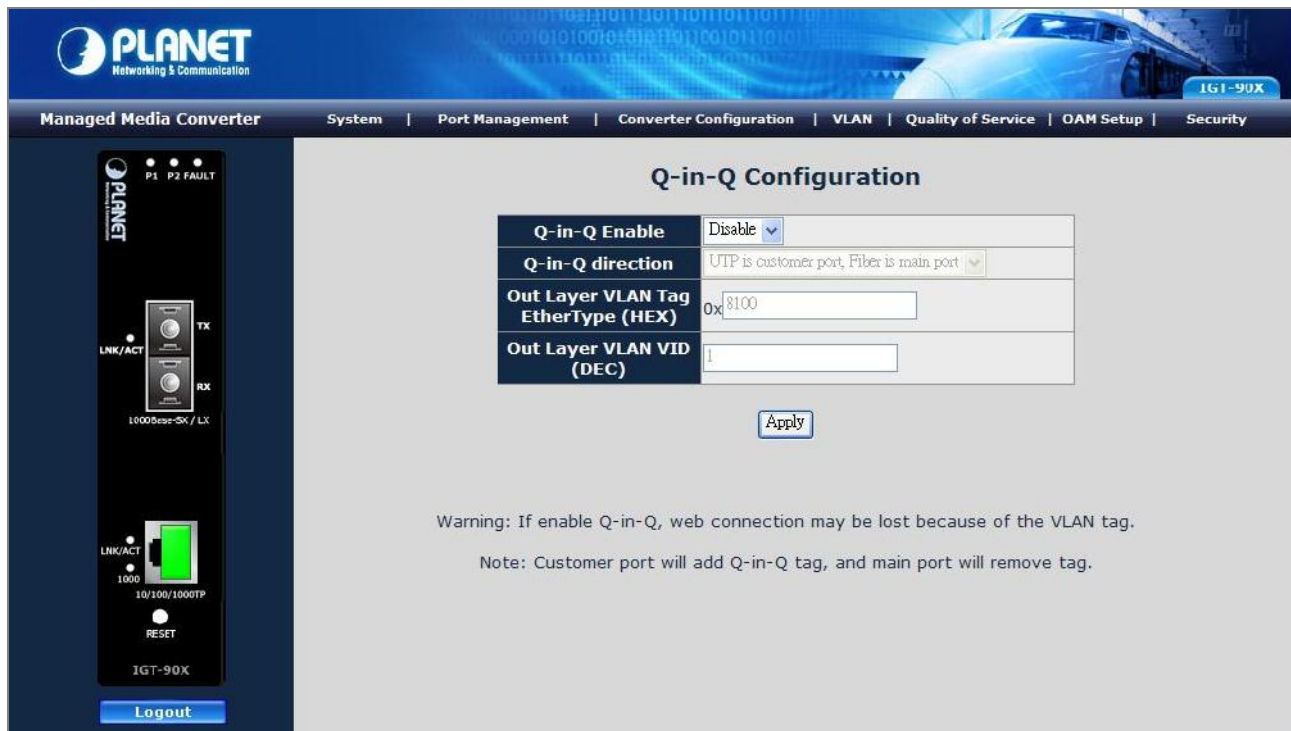

Figure 4-29 Q-in-Q VLAN setting Web Page screen

The Q-in-Q VLAN setting Web page includes the following configurable data:

<b>Q-in-Q Enable</b>	Provide disable or enable the Q-in-Q VLAN function. Default mode is <b>Disable</b> .
<b>Q-in-Q Direction</b>	Provide two directions for Q-in-Q function, the available options are: <b>UTP is customer port, Fiber is main port</b> <b>Fiber is customer port, UTP is main port</b> Default mode is <b>UTP is customer port, Fiber is main port</b> .
<b>Out Layer VLAN Tag EtherType (HEX)</b>	Allow defined the Out Layer VLAN Tag Ether Type and default mode is <b>0x8100</b> .
<b>Out Layer VLAN VID (DEC)</b>	Allow defined the Out Layer VLAN VID and default mode is <b>1</b> .
<b>Apply Button</b>	Press this button for save current configuration of IGT-90X.

Table 4-11 Descriptions of the Q-in-Q VLAN setting Web Page Screen Objects



## 4.6 Quality of Service

Quality of Service (QoS) is an advanced traffic prioritization feature that allows you to establish control over network traffic. QoS enables you to assign various grades of network service to different types of traffic, such as multi-media, video, protocol-specific, time critical, and file-backup traffic.

QoS reduces bandwidth limitations, delay, loss, and jitter. It also provides increased reliability for delivery of your data and allows you to prioritize certain applications across your network. You can define exactly how you want the switch to treat selected applications and types of traffic.

You can use QoS on your system to:

- Control a wide variety of network traffic by:
- Classifying traffic based on packet attributes.
- Assigning priorities to traffic (for example, to set higher priorities to time-critical or business-critical applications).
- Applying security policy through traffic filtering.
- Provide predictable throughput for multimedia applications such as video conferencing or voice over IP by minimizing delay and jitter.
- Improve performance for specific types of traffic and preserve performance as the amount of traffic grows.
- Reduce the need to constantly add bandwidth to the network.
- Manage network congestion.

This function provides Quality of Service setting of IGT-90X. Press the **“Apply”** button to save the current configuration. The screen in [Figure 4-30](#) appears and [Table 4-12](#) describes the Quality of Service object of IGT-90X.

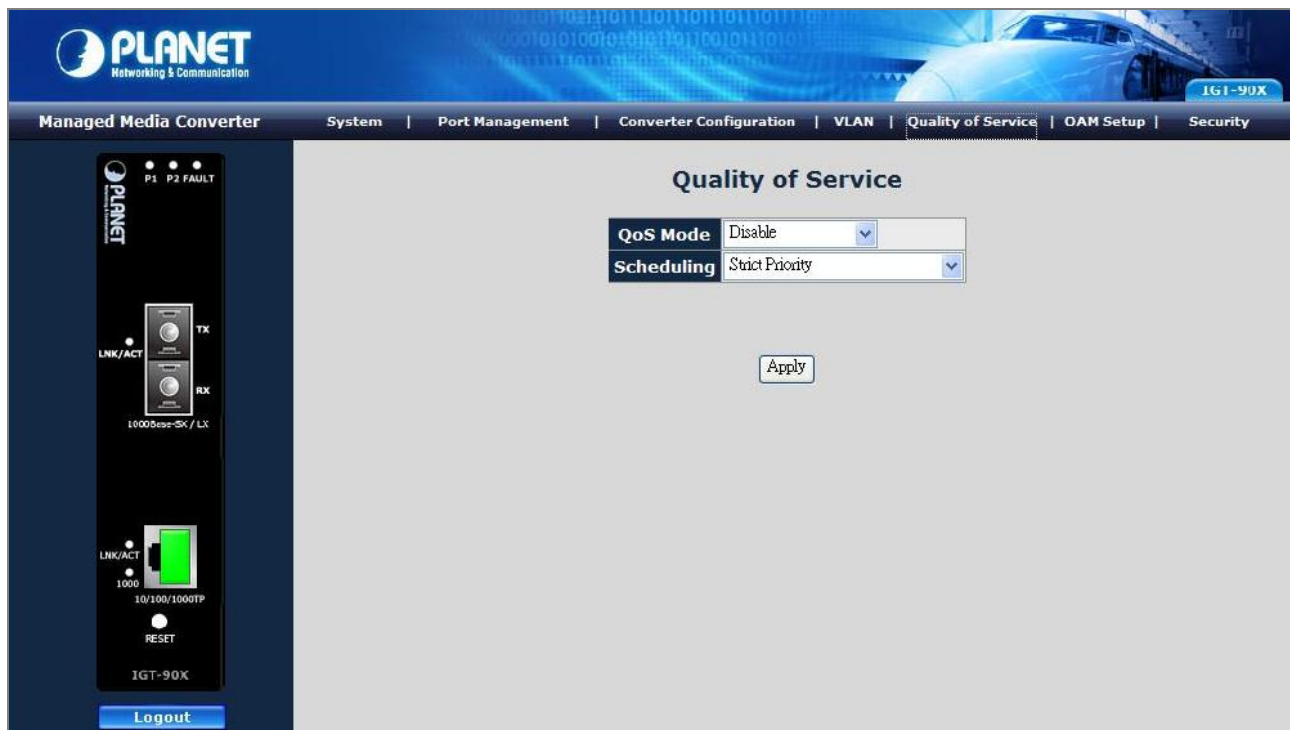

Figure 4-30 Quality of Service Web Page screen

The Quality of Service Web page includes the following configurable data:

<p><b>QoS Mode</b></p>	<p>Provide 4 different QoS mode for operation, the available options are:</p> <p><b>Disable</b></p> <p><b>802.1p Tag Priority</b></p> <p>The 802.1p Tag Priority field as show in <a href="#">Figure 4-31</a>.</p> <p><b>IP Address Priority</b></p> <p>The IP Address Priority field as show in <a href="#">Figure 4-32</a>.</p> <p><b>IP DSCP Priority</b></p> <p>The IP DSCP Priority field as show in <a href="#">Figure 4-33</a>.</p> <p>Default mode is <b>Disable</b>.</p>
<p><b>Scheduling</b></p>	<p>Provide two scheduling method for Quality of Service, the available options are:</p> <p><b>Strict Priority</b></p> <p><b>Weighted Round Robin (16:8:4:1)</b></p> <p>Default mode is <b>Strict Priority</b>.</p>
<p><b>Apply Button</b></p>	<p>Press this button for save current configuration of IGT-90X.</p>

Table 4-12 Descriptions of the Quality of Service Web Page Screen Objects

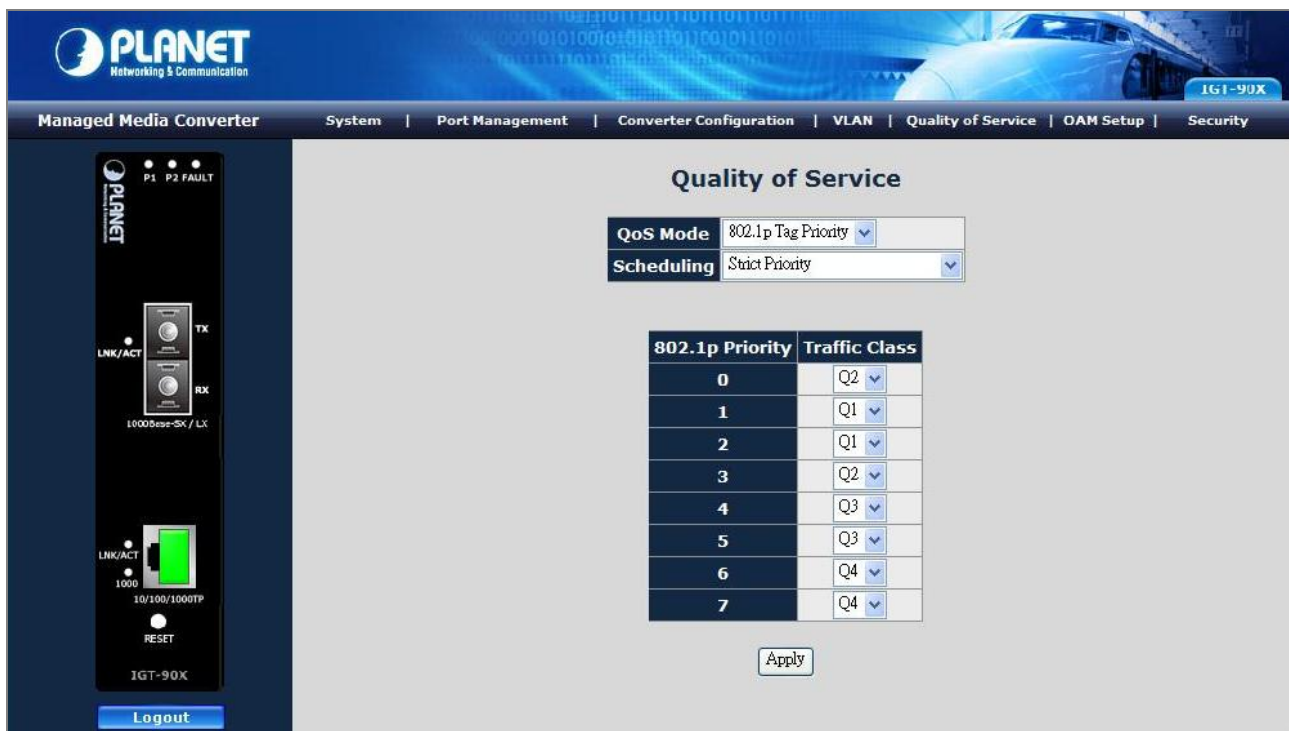

Figure 4-31 802.1p Tag Priority Web Page screen

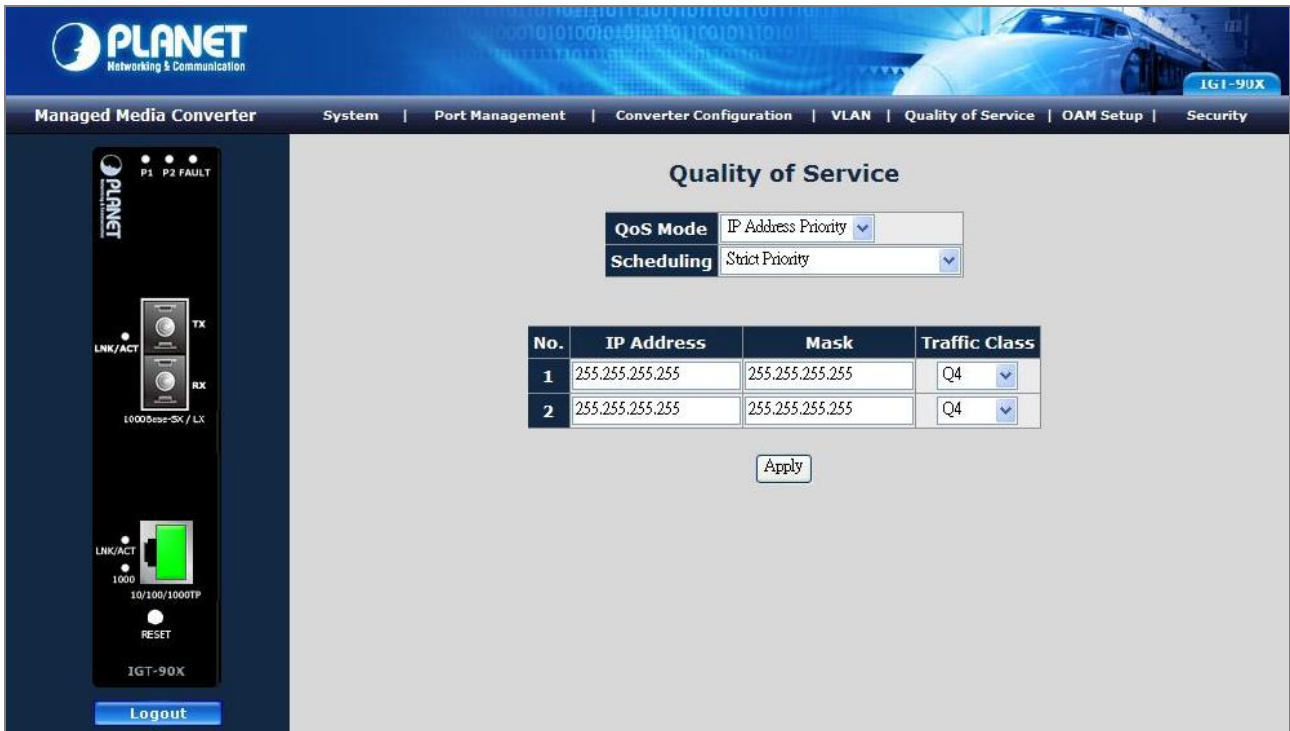

Figure 4-32 IP Address Priority Web Page screen

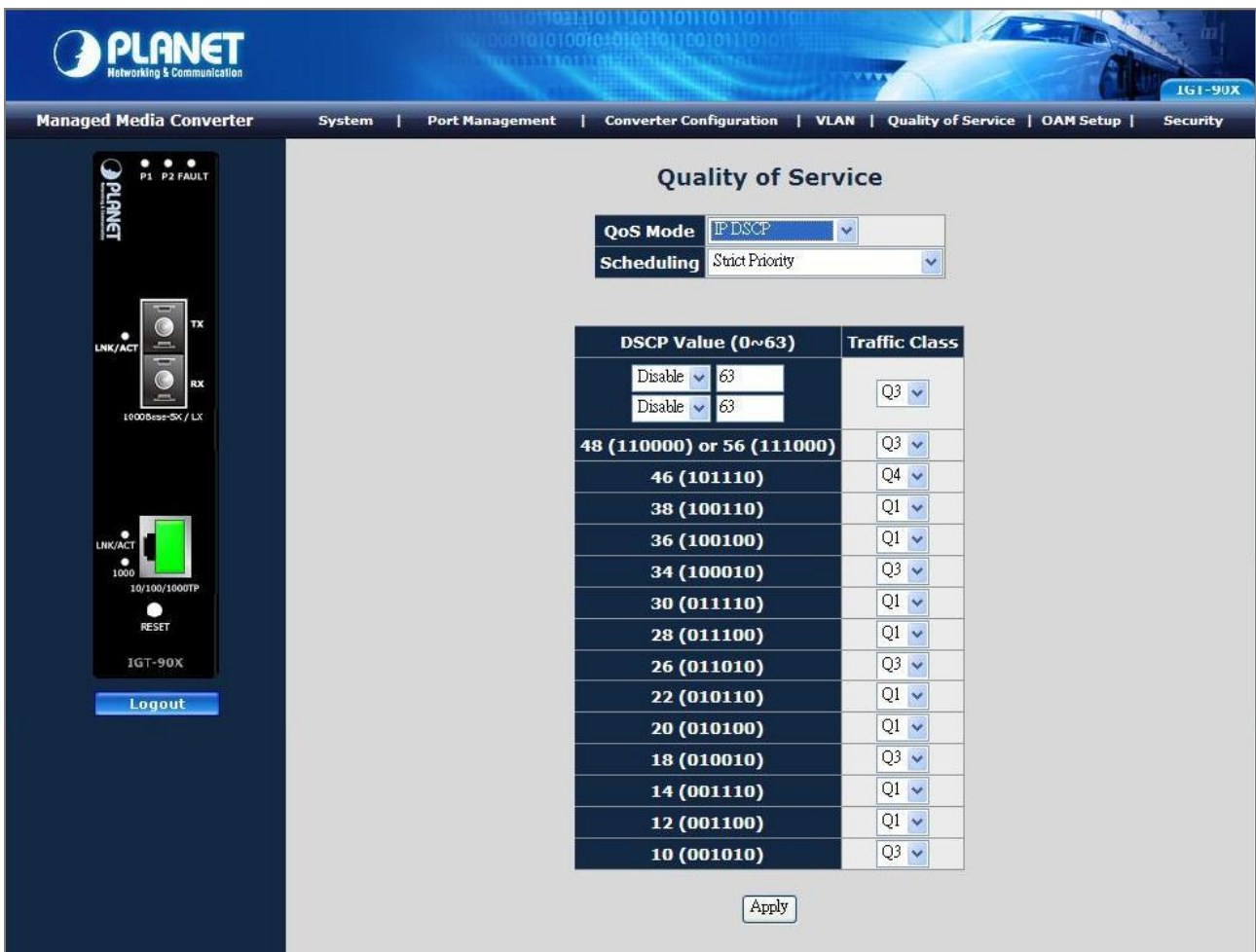

Figure 4-33 IP DSCP Priority Web Page screen



On the top of DSCP Value table have two could be set. The default DSCP value is 63. These two fields are both for customize DSCP value.

## 4.7 OAM Setup

### 4.7.1 Local TS-1000 OAM Setup

This function provides Local TS-1000 OAM Setup of IGT-90X. Press the “**Apply**” button to save the current configuration of Industrial Managed Media Converter. The screen in [Figure 4-34](#) appears and [Table 4-13](#) describes the Local TS-1000 OAM Setup object of Industrial Managed Media Converter.

The screenshot shows the 'Local TS-1000 OAM Configuration' web page. On the left is a vertical sidebar with a device image and a 'Logout' button. The main content area has a title bar with navigation tabs: Managed Media Converter, System, Port Management, Converter Configuration, VLAN, Quality of Service, OAM Setup, and Security. The configuration section includes:

TS-1000 OAM State	Enable
TS-1000 Mode	Terminal
Link Transparent	Disable
Link Transparent Result	Local Link Transparent is Disable. Remote Config Fail. Should Enable TS1000 and Set It as Center

Below the configuration is an 'Apply' button. The status section is titled 'Local TS-1000 OAM Status' and includes:

TS1000 Function	Enable
TS1000 Mode	Terminal
Power Status	Normal
NetlinkStatus	UTP Established
LossOpNotifWay	with alarm FEF1
Operation Status	under ordinary operation
MCOptionB	Support
Terminal Link Rate	1000M
Terminal Link Duplex	Full
Terminal Link Nway	Enable
NumPhyInterface	One

Figure 4-34 Local TS-1000 OAM Setup Web Page screen

The Local TS-1000 OAM Setup Web page includes the following configurable data:

<b>TS-1000 OAM State</b>	Provide disable or enable the TS-1000 OAM operation mode. Default mode is <b>Disable</b> .
<b>TS-1000 Mode</b>	Provide two TS-1000 modes for operation, the available options are: <b>Terminal</b> <b>Center</b> Default mode is <b>Terminal</b> .
<b>Link Transparent</b>	Provide disable or enable the Link Transparent function. Default mode is <b>Disable</b> .
<b>Link Transparent Result</b>	Display the link transparent result.
<b>Apply Button</b>	Press this button for save current configuration of Industrial Managed Media Converter.

Table 4-13 Descriptions of the Local TS-1000 OAM Setup Web Page Screen Objects

## 4.7.2 Remote TS-1000 OAM Setup

The Remote TS-1000 OAM Setup is an advanced remote device monitor feature that allows you to remote monitor and automatic notify status indication.

### Remote monitor

1. User instructs center Media Converter to issue a status notification request frame defined in TS-1000 to get status of terminal Media Converter.
2. Terminal Media Converter receives the status notification request frame and sends out status response frame, which carries its current status.

### Autonomous notification

1. Terminal Industrial Media Converter notifies the center Industrial Media Converter autonomously with a status notification indication, if any change occurs in the status monitored internally by the terminal Industrial Media Converter.
2. Center Industrial Media Converter if support Option A, notifies the terminal Industrial Media Converter autonomously with a status notification indication, if any change occurs in the status monitored internally by the Industrial center Media Converter.

This function provides Remote TS-1000 OAM Setup of Industrial Managed Media Converter. Press the **“Apply”** button to save the current configuration of Industrial Managed Media Converter. The screen in [Figure 4-35 & 4-36](#) appears.

The screenshot displays the web interface for the IGT-90x device. The top navigation bar includes 'Managed Media Converter', 'System', 'Port Management', 'Converter Configuration', 'VLAN', 'Quality of Service', 'OAM Setup', and 'Security'. The main content area is titled 'Remote Port Configuration' and contains a table with the following data:

Port	Admin	Mode	Flow Control	Ingress Rate Limit	Egress Shaping
TP	Link Up	Auto Speed	Disabled	No Limit	No Limit
Fiber	Link Up	Auto Speed	Disabled	No Limit	No Limit

Below the table is an 'Apply' button. The section below is titled 'TS-1000 OAM Remote Information' and contains a table with the following data:

Machine Name	IGT-90X			
Remote IP Address	0.0.0.0			
Remote MAC Address	00.00.00.00.00.00			
Port	Link Status	Speed	Duplex Mode	Flow Control
TP	Link Down	1000	Full	Disable
Fiber	Link up	1000	Full	Disable

At the bottom of the information section is a 'Refresh' button. On the left side of the page, there is a vertical sidebar with a 'Logout' button and a status panel for the IGT-90X device, showing indicators for P1, P2, TX, RX, and a 'RESET' button.

Figure 4-35 IGT-90x Remote TS-1000 OAM Setup Web Page screen

**Managed Media Converter** | System | Port Management | Converter Configuration | VLAN | Quality of Service | OAM Setup | Security

### Remote Port Configuration

Port	Admin	Mode	Flow Control	Ingress Rate Limit	Egress Shaping
TP	Link Up	Auto Speed	Disabled	No Limit	No Limit
Fiber	Link Up	Auto Speed	Disabled	No Limit	No Limit

Apply

### TS-1000 OAM Remote Information

Machine Name	IGT-90X			
Remote IP Address	192.168.0.100			
Remote MAC Address	00:30:4f:00:01:01			
Port	Link Status	Speed	Duplex Mode	Flow Control
TP	Link up	100	Full	Disable
Fiber	Link up	1000	Full	Disable

Refresh

Logout

Figure 4-36 IGT-90X Remote TS-1000 OAM Setup Web Page screen



Please use the PLANET GT-80X / GT-90X / IGT-90X as the Remote device.

### 4.7.3 TS-1000 Loop Back Test

The TS-1000 Loop Back Test allows manual run this loop back test to check the interconnection between two Industrial Media Converter devices. To assure the Remote TS-1000 OAM function can work correctly.

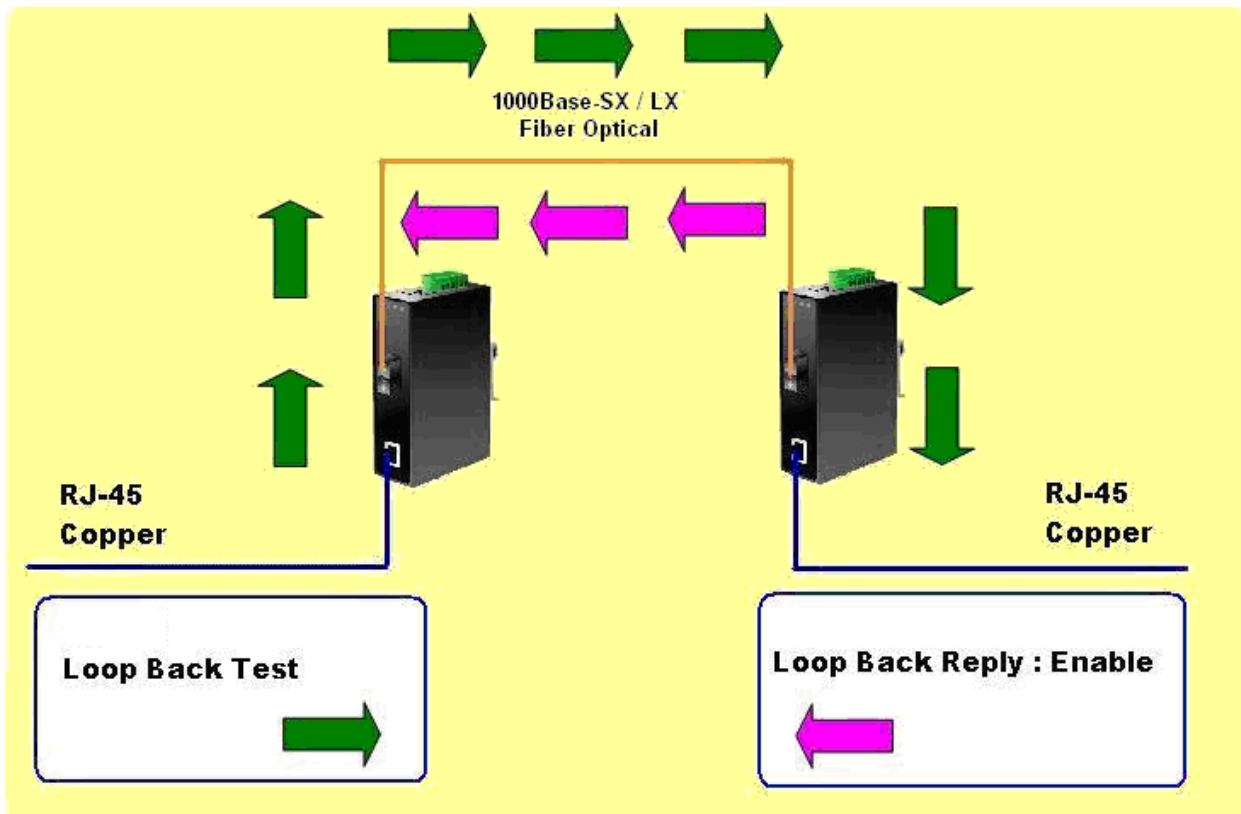

#### In-band and out-band Loop back

1. Instruct center Industrial Media Converter to issue an OAM frame to request a loop back test. Terminal return start response OAM frame to center Media Converter.
2. Terminal Media Converter runs at loop back mode.
3. Central Media Converter send test frame and terminal Media Converter loop back the frames. Test frame can be generated from central Industrial Media Converter's UTP port (Out-Band) or from central Industrial Media Converter (In-Band) automatically.
4. Center Industrial Media Converter check the loop back test result after sending all test frames
5. Instruct the central Industrial Media Converter to end loop back test.

This function provides TS-1000 Loop Back Test of Industrial Managed Media Converter. Press the **"Apply"** button to run Loop Back Test and see the TS-1000 Loop Back Test Result of Industrial Managed Media Converter, also press the **"Refresh"** button to renew the Web screen. The screen in [Figure 4-37](#) appears and [Table 4-14](#) describes the TS-1000 Loop Back Test object of Industrial Managed Media Converter.

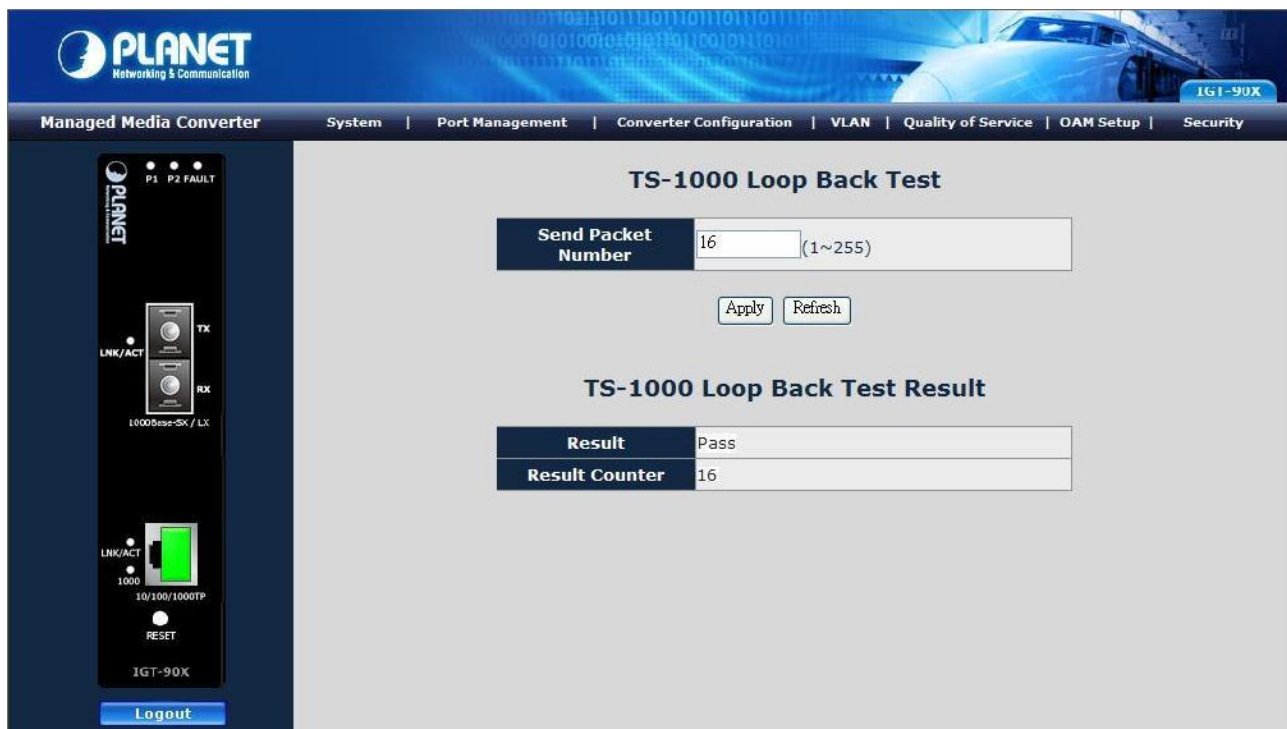

Figure 4-37 Remote TS-1000 Loop Back Test Web Page screen

The TS-1000 Loop Back Test Web page includes the following configurable data:

TS-1000 Loop Back Test	
<b>Send Packet Number</b>	Allow input the number for packet send and the available options is 1 to 255. Default is <b>16</b> .
<b>Apply Button</b>	Press this button for save current configuration of Industrial Managed Media Converter.
<b>Refresh Button</b>	Press “ <b>Refresh</b> ” button to refresh current status.
TS-1000 Loop Back Test Result	
<b>Result</b>	Display the TS-1000 Loop Back Test Result. Fail or Pass.
<b>Result counter</b>	Display the value of Counter Result.

Table 4-14 Descriptions of the TS-1000 Loop Back Test Web Page Screen Objects



Note

Please use the PLANET GT-80X / GT-90X / IGT-90X as the Remote device.



#### 4.7.4 802.3ah Setup

When enable 802.3ah OAM function, all 802.3ah OAMPDU packets will trap to embedded CPU.

Software will implement auto discovery procedure. With hardware support, software controls the 802.3ah remote loop back procedure. Hardware can also detect dying gasp even and interrupt CPU to send dying gasp even notification OAMPDU. All other functions defined by 802.3ah are implemented using embedded CPU.

When remote device is in loop back mode, hardware can support change looped test frame's DA, SA or both as user defined. Hardware can also set to don't change looped test frame.

This function provides 802.3ah Setup of Industrial Managed Media Converter. Press the “**Apply**” button to save the current configuration of Industrial Managed Media Converter. The screen in [Figure 4-38](#) appears and [Table 4-15](#) describes the 802.3ah Setup object of Industrial Managed Media Converter.

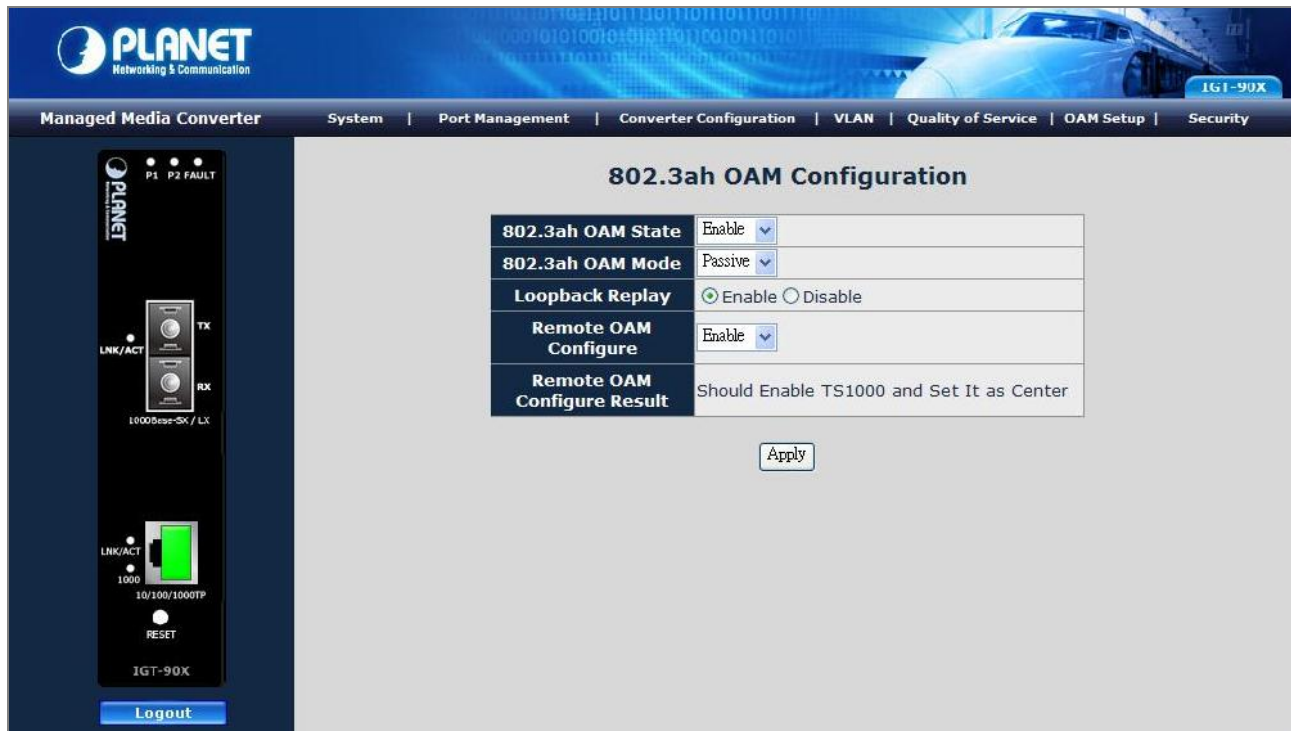

**Figure 4-38** 802.3ah Setup Web Page screen

The 802.3ah Setup Web page includes the following configurable data:

<b>802.3ah OAM State</b>	Provide disable or enable the 802.3ah OAM State function. Default mode is <b>Enable</b> .
<b>802.3ah OAM Mode</b>	Allow to choose “ <b>Active</b> ” or “ <b>Passive</b> ” for 802.3ah OAM Mode. Default mode is <b>Passive</b> .
<b>Loopback Reply</b>	Provide disable or enable the Loopback Reply function. Default mode is <b>Enable</b> .
<b>Remote OAM Configure</b>	Provide disable or enable the Remote OAM Configure function. Default mode is <b>Enable</b> .
<b>Remote OAM Configuration Result</b>	Display the Remote OAM Configuration Result.
<b>Apply Button</b>	Press this button for save current configuration of Managed Media Converter.

**Table 4-15** Descriptions of the 802.3ah Setup Web Page Screen Objects



Note

1. The 802.3ah function must work with manageable device that supports 802.3ah function.
2. Please use the PLANET GT-80X / GT-90X / IGT-90X as the Remote device.

### 4.7.5 802.3ah Loop Back Test

The 802.3ah Loop Back Test allows manual run this loop back test to check the interconnection between two Industrial Media Converter devices. To assure the Remote 802.3ah function can work correctly.

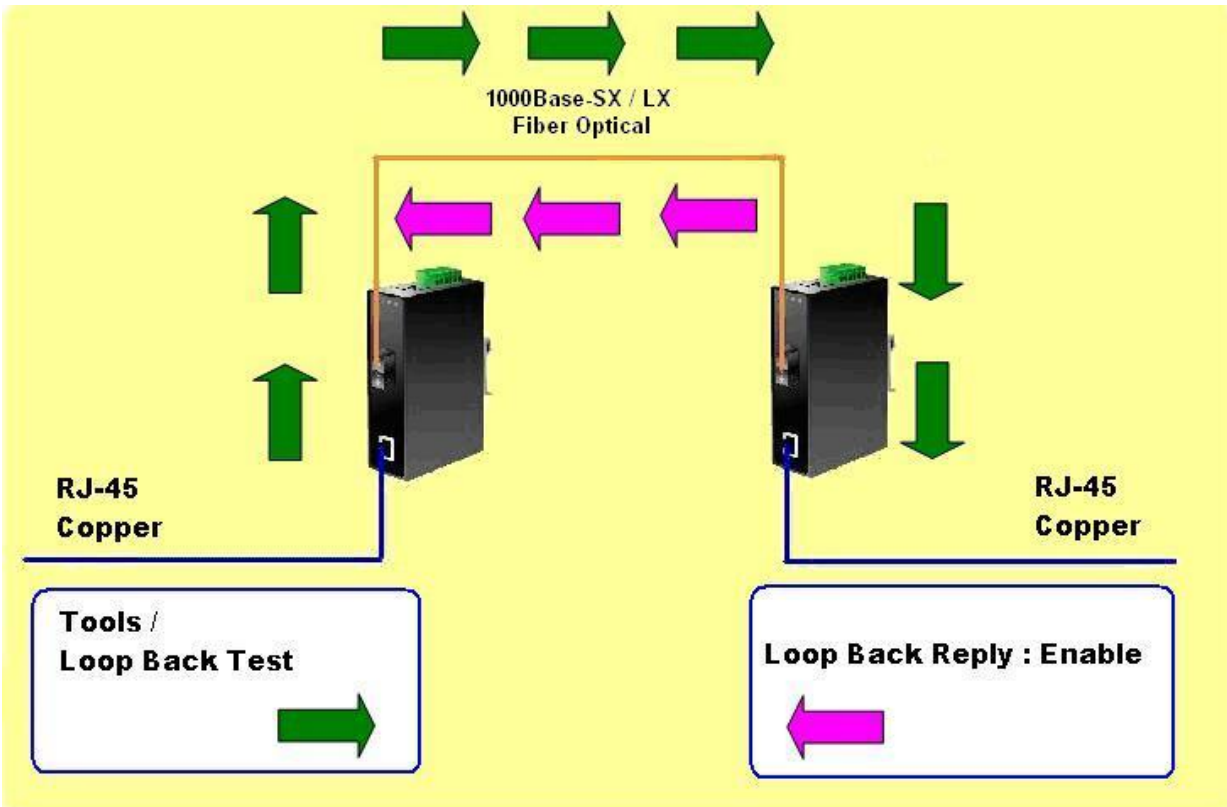

This function provides 802.3ah Loop Back Test of Industrial Managed Media Converter. Press the “**Apply**” button to run 802.3ah Loop Back Test and see the 802.3ah Loop Back Test Result of Industrial Managed Media Converter, also press the “**Refresh**” button to renew the Web screen. The screen in [Figure 4-39](#) appears and [Table 4-16](#) describes the 802.3ah Loop Back Test object of Industrial Managed Media Converter.

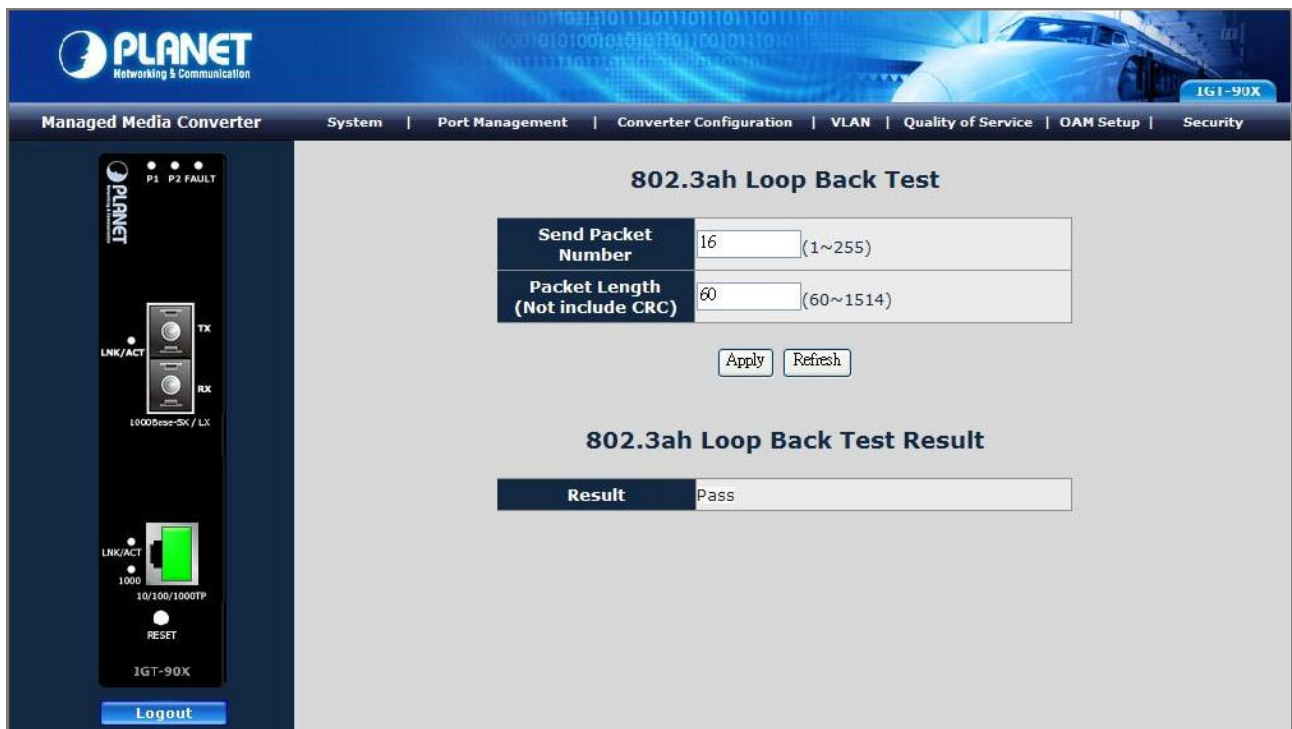

Figure 4-39 802.3ah Loop Back Test Web Page screen

The 802.3ah Loop Back Test Web page includes the following configurable data:

802.3ah Loop Back Test	
<b>Send Packet Number</b>	Allow input the number for packet send and the available options is 1 to 255. Default is <b>16</b> .
<b>Packet Length (Not include CRC)</b>	Allow input the number for Packet Length and the available options is 60 to 1514. Default is <b>60</b> .
<b>Apply Button</b>	Press this button for save current configuration of Industrial Managed Media Converter.
<b>Refresh Button</b>	Press " <b>Refresh</b> " button to refresh current status.
802.3ah Loop Back Test Result	
<b>Result</b>	Display the 802.3ah Loop Back Test Result. Fail or Pass.

**Table 4-16** Descriptions of the 802.3ah Loop Back Test Web Page Screen Objects



1. The 802.3ah function must work with manageable device that supports 802.3ah function.
2. Please use the PLANET GT-80X / GT-90X / IGT-90X as the Remote device.

## 4.8 Security

This function provides TCP / UDP Filter setting of Industrial Managed Media Converter. Press the “**Apply**” button to save the current configuration of Industrial Managed Media Converter. The screen in [Figure 4-40](#) appears and [Table 4-17](#) describes the TCP / UDP Filter setting object of Industrial Managed Media Converter.

The screenshot shows the 'TCP/UDP Filter' configuration page. The main configuration area includes the following fields and options:

- Group ID:** Input field with a range of (1~16).
- Action:** Dropdown menu set to 'Permit'.
- Egress Port:** Dropdown menu set to 'TP'.
- Packet Type:** Radio buttons for 'IPv4' (selected) and 'Non-IPv4'.
- L4 Protocol:** Radio buttons for 'TCP Any' (selected), 'UDP Any', and 'TCP or UDP'. Each has a 'Port#:' input field.
- Ether Type:** Radio buttons for 'Any' (selected) and 'Type(HEX) 0x'. The 'Any' option has a 'Type(HEX) 0x' input field.
- Current List:** A table with columns: Del, ID, Action, Egress, Packet Type, Port Num or Eth Type.
- Buttons:** 'Add' and 'Del' buttons below the current list.

Figure 4-40 Security setting Web Page screen

The Quality of Service Web page includes the following configurable data:

<b>Group ID</b>	Provide input the group ID for TCP / UDP Filter and the available range is 1 to 16.
<b>Action</b>	Provide “ <b>Deny</b> ” or “ <b>Permit</b> ” options and default mode is <b>Permit</b> .
<b>Egress Port</b>	Provide choose “ <b>TP</b> ” or “ <b>Fiber</b> ” as Egress Port. Default mode is <b>TP</b> .
<b>Packet Type</b>	Provide IPv4 and Non-IPv4 protocol for further setting.
<b>L4 Protocol</b>	Provide IPv4 and Non-IPv4 protocol for further setting. IPv4: <b>TCP Any / FTP (21) / HTTP (80), UDP Any / TFTP (69)</b> Non-IPv4: <b>Any / ARP (0x0806) / IPX (0x8137)</b>
<b>Current List</b>	Display current TCP / UDP Filter Groups.
<b>Add Button</b>	Press this button for add new TCP / UDP Filter group into current list.
<b>Del Button</b>	Press this button for delete existence TCP / UDP Filter group from current list.

Table 4-17 Descriptions of the Security setting Web Page Screen Objects

## 4.9 Logout

This function provides Logout function of Industrial Managed Media Converter, when the “Are you sure to logout” pop window appears; press the “OK” button to logout Web page of Industrial Managed Media Converter. The screen in [Figure 4-41 & 4-42](#) appears.

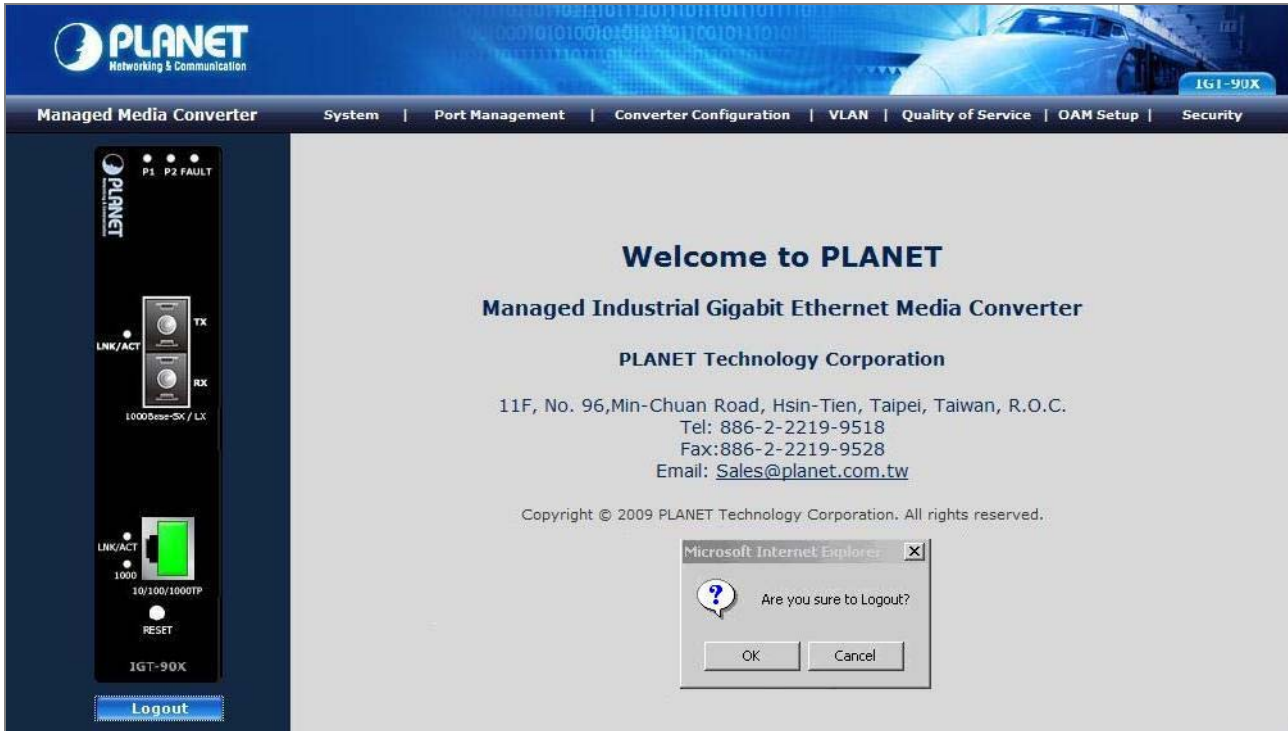

Figure 4-41 Logout Web Page screen

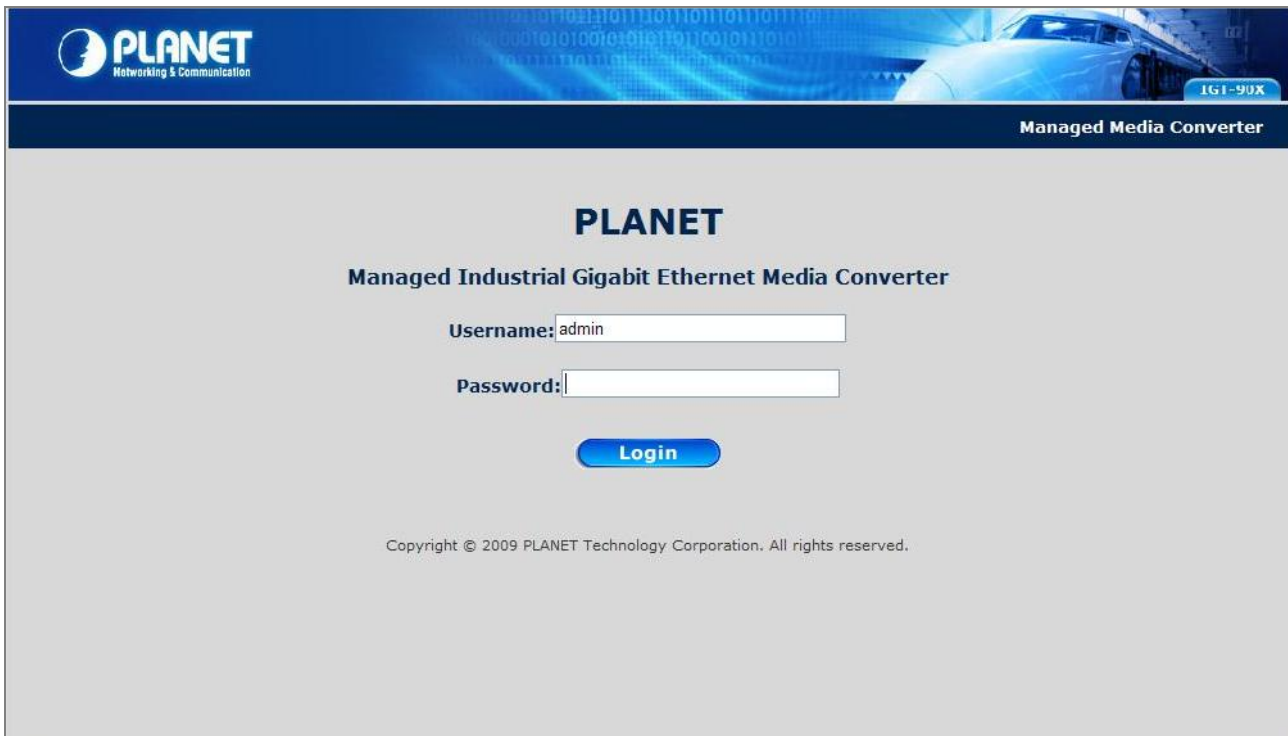

Figure 4-42 Login Web Page screen

## 5. TROUBLE SHOOTING

This chapter contains information to help you solve problems. If the media converter is not functioning properly, make sure the media converter was set up according to instructions in this manual.

### The Link LED is not lit

Solution:

1. Check the cable connection and remove duplex mode of the Industrial Managed Media Converter.
2. Check the port configuration of the link partner; make sure the two side devices with the same link configuration.

### Performance is bad

Solution:

Check the full duplex status of the device. If the device is set to full duplex and the partner is set to half duplex, then the performance will be poor.

### 10/100/1000Base-T port link LED is lit, but the traffic is irregular

Solution:

Check that the attached device is not set to dedicate full duplex. Some devices use a physical or software switch to change duplex modes. Auto-negotiation may not recognize this type of full-duplex setting.

### Why the device doesn't connect to the network

Solution:

Check the LNK/ACT LED on the Industrial Managed Media Converter .Try another port on the connected device. Make sure the cable is installed properly Make sure the cable is the right type Turn off the power. After a while, turn on power again.

### How to deal forgotten password situation of device?

Solution:

The Industrial Managed Media Converter is implemented with "Reset" button, press the button at the front panel about 10 seconds. After the device is booted then login the Web Management page with default user name and password (admin).

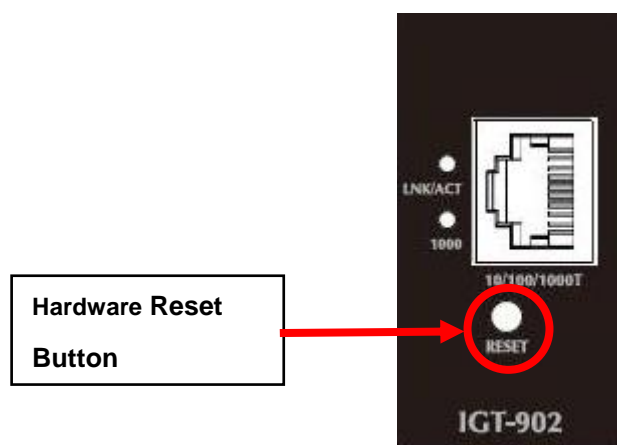

# APPENDIX A NETWORKING CONNECTION

## A.1 Device's RJ-45 Pin Assignments

### ■ 1000Mbps, 1000Base T

RJ-45 Connector pin assignment		
Contact	MDI	MDI-X
1	BI_DA+	BI_DB+
2	BI_DA-	BI_DB-
3	BI_DB+	BI_DA+
4	BI_DC+	BI_DD+
5	BI_DC-	BI_DD-
6	BI_DB-	BI_DA-
7	BI_DD+	BI_DC+
8	BI_DD-	BI_DC-

### 10/100Mbps, 10/100Base-TX

RJ-45 Connector pin assignment		
Contact	MDI Media Dependant Interface	MDI-X Media Dependant Interface -Cross
1	Tx + (transmit)	Rx + (receive)
2	Tx - (transmit)	Rx - (receive)
3	Rx + (receive)	Tx + (transmit)
4, 5	Not used	
6	Rx - (receive)	Tx - (transmit)
7, 8	Not used	

## A.2 RJ-45 Cable Pin Assignment

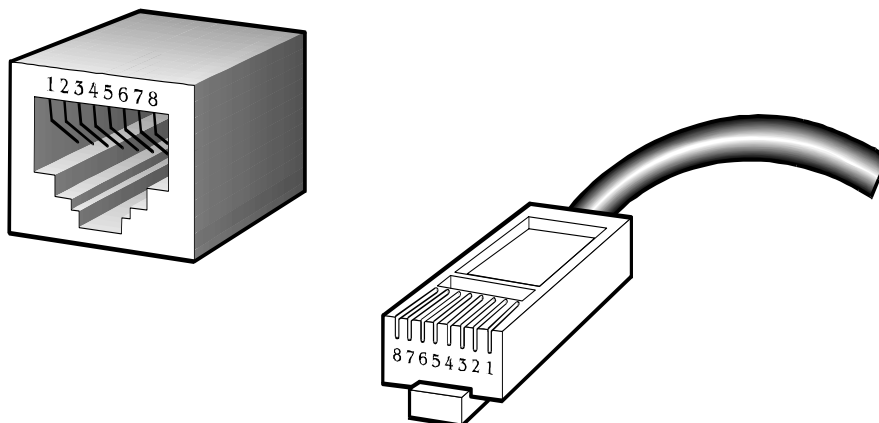

The standard RJ-45 receptacle/connector

There are 8 wires on a standard UTP/STP cable and each wire is color-coded. The following shows the pin allocation and color of straight cable and crossover cable connection:

Straight Cable		SIDE 1	SIDE2
	<p><b>SIDE 1</b></p> <p><b>SIDE 2</b></p>	<p>1 = White / Orange</p> <p>2 = Orange</p> <p>3 = White / Green</p> <p>4 = Blue</p> <p>5 = White / Blue</p> <p>6 = Green</p> <p>7 = White / Brown</p> <p>8 = Brown</p>	<p>1 = White / Orange</p> <p>2 = Orange</p> <p>3 = White / Green</p> <p>4 = Blue</p> <p>5 = White / Blue</p> <p>6 = Green</p> <p>7 = White / Brown</p> <p>8 = Brown</p>
Straight Cable		SIDE 1	SIDE2
	<p><b>SIDE 1</b></p> <p><b>SIDE 2</b></p>	<p>1 = White / Orange</p> <p>2 = Orange</p> <p>3 = White / Green</p> <p>4 = Blue</p> <p>5 = White / Blue</p> <p>6 = Green</p> <p>7 = White / Brown</p> <p>8 = Brown</p>	<p>1 = White / Orange</p> <p>2 = Green</p> <p>3 = White / Orange</p> <p>4 = Blue</p> <p>5 = White / Blue</p> <p>6 = Orange</p> <p>7 = White / Brown</p> <p>8 = Brown</p>

Figure A-1: Straight-Through and Crossover Cable

Please make sure your connected cables are with same pin assignment and color as above picture before deploying the cables into your network.

### A.3 Fiber Optical Cable Connection Parameter

The wiring details are as below:

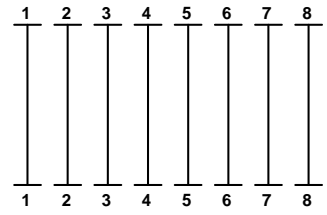
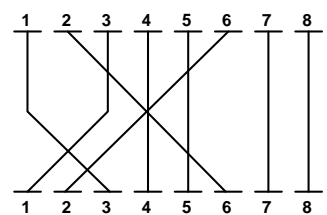
■ **Fiber Optical patch Cables:**

Standard	Fiber	Diameter (micron)	Modal Bandwidth (MHz * km)	Max. Distance (meters)
1000Base-SX	Multi-mode	62.5	100	220
		62.5	200	275
		50	400	500
		50	500	550
1000Base-LX	Multi-mode	62.5	5	550
		50	4	
		50	5	
	Single-mode	9	N/A	5000*



## EC Declaration of Conformity

For the following equipment:

\*Type of Product : Industrial Managed Gigabit Ethernet Media Converter  
\*Model Number : **IGT-902, IGT-902S, IGT-905A, IGT-902T, IGT-902TS**

\* Produced by:

Manufacturer's Name : **Planet Technology Corp.**  
Manufacturer's Address : 11F, No. 96, Min Chuan Road, Hsin Tien,  
Taipei, Taiwan, R.O.C.

is herewith confirmed to comply with the requirements set out in the Council Directive on the Approximation of the Laws of the Member States relating to Electromagnetic Compatibility Directive on (2004/108/EC).

For the evaluation regarding the EMC, the following standards were applied:

Emission	EN 55022	(CLASS A: 2006 + A1:2007)
Harmonic	EN 61000-3-2	(2006)
Flicker	EN 61000-3-3	(1995 + A1:2001 + A2:2005)
Immunity	EN 55024	(1998 + A1:2001 + A2:2003)
ESD	IEC 61000-4-2	(2001)
RS	IEC 61000-4-3	(2008)
EFT/ Burst	IEC 61000-4-4	(2004)
Surge	IEC 61000-4-5	(2005)
CS	IEC 61000-4-6	(2008)
Magnetic Field	IEC 61000-4-8	(2001)
Voltage Disp	IEC 61000-4-11	(2004)

Responsible for marking this declaration if the:

Manufacturer       Authorized representative established within the EU

Authorized representative established within the EU (if applicable):

Company Name:      **Planet Technology Corp.**

Company Address:    **11F, No.96, Min Chuan Road, Hsin Tien, Taipei, Taiwan, R.O.C**

Person responsible for making this declaration

Name, Surname      **Kent Kang**

Position / Title :    **Product Manager**

Taiwan  
Place

16<sup>th</sup>, March., 2010  
Date



Legal Signature

**PLANET TECHNOLOGY CORPORATION**

e-mail: sales@planet.com.tw    http://www.planet.com.tw

11F, No. 96, Min Chuan Road, Hsin Tien, Taipei, Taiwan, R.O.C. Tel:886-2-2219-9518 Fax:886-2-2219-9528