

Industrial L3 16-Port 10/100/1000T with 8-/16-Port 802.3at PoE M12 + 2-Port 10GBASE-T M12 Bypass + 2-Port 10G Q-ODC Managed Ethernet Switch



Advanced Layer 3 Managed PoE Switch for Railway Transportation and Harsh Environments

PLANET ITS-6326 Industrial Managed Switch Series, featuring PoE, 10G M12 connector, and Q-ODC (Quad Optical Direct Connect), is specifically designed for railway system. Compliant with **EN50155**, **EN45545-2**, and **IEC 61373** standards, it offers robust features tailored to excel in demanding environments. This series supports dual-stack management for both IPv6 and IPv4, incorporates built-in Layer 3 OSPFv2 dynamic routing, and is powered by a high-performance Layer 2/Layer 4 Gigabit switching engine.

This series provides extensive functionality, making it ideal for both railway and heavy industrial applications. Equipped with M12 X-code and Q-ODC connectors for each port, it ensures reliable and stable performance. With the capability to operate seamlessly in extreme temperatures ranging from -40 to 70°C, it offers exceptional adaptability, durability, and silent operation, making it suitable for the harshest industrial conditions.

Also, this series is available in three distinct models, as detailed in the table below. This variety provides users with the flexibility to choose the model that best meets their specific needs.

	ITS-6326-16P2TB2XS-WV	ITS-6326-16P2T2XS-WV	ITS-6326-8P10T2XS-WV
10/100/1000BASE-T, M12, 8-pin X-coded Connector	-	-	8
10/100/1000BASE-T, M12, 8-pin X-coded Connector with 802.3at PoE+	16	16	8
10G/5G/2.5G/1GBASE-T, M12, 8-pin X-coded Connector	2	2	2
Power Failure Bypass Pair; Link Speed up to 10GBASE-T	1-pair (Ports 17-18)	-	-
10GBASE-X, Q-ODC Fiber Port	2	2	2
Power Input Voltage	24 to 110 VDC		

Physical Port

ITS-6326-16P2TB2XS-WV

- **16 x 10/100/1000BASE-T M12 ports (Ports 1 to 16)** with **IEEE 802.3at PoE+** injector function
- **2 x 10GBASE-T M12 ports (Ports 17 to 18)** with **bypass relay**, backward compatible with 5G/2.5G/1GMbps data rate
- **2 x 10GBASE-X Q-ODC fiber connector (Ports 19 to 20)**
- One M12 A-coded 5-pin male connector for USB data to RS232 console interface for basic management and setup
- One M12 A-coded 5-pin male connector with alarm, digital input and digital output functions
- One M23 A-coded 5-pin male connector with **input voltage range of 24 to 110 VDC (Operating voltage: 16.8 to 137.5 VDC)**

ITS-6326-16P2T2XS-WV

- **16 x 10/100/1000BASE-T M12 ports (Ports 1 to 16)** with **IEEE 802.3at PoE+** injector function
- **2 x 10GBASE-T M12 ports (Ports 17 to 18)**, backward compatible with 5G/2.5G/1G/100Mbps data rate
- **2 x 10GBASE-X Q-ODC fiber connector (Ports 19 to 20)**
- One M12 A-coded 5-pin male connector for USB data to RS232 console interface for basic management and setup
- One M12 A-coded 5-pin male connector with alarm, digital input and digital output functions
- One M23 A-coded 5-pin male connector with **input voltage range of 24 to 110 VDC (Operating voltage: 16.8 to 137.5 VDC)**

ITS-6326-8P10T2XS-WV

- **8 x 10/100/1000BASE-T M12 ports (Ports 1 to 8)** with **IEEE 802.3at PoE+** injector function
- **8 x 10/100/1000BASE-T M12 ports (Ports 9 to 16)**
- **2 x 10GBASE-T M12 ports (Ports 17 to 18)**, backward compatible with 5G/2.5G/1G/100Mbps data rate
- **2 x 10GBASE-X Q-ODC fiber connector (Ports 19 to 20)**
- One M12 A-coded 5-pin male connector for USB data to RS232 console interface for basic management and setup
- One M12, A-coded 5-pin male connector with alarm, digital input and digital output function
- One M23 A-coded 5-pin male connector with **input voltage range of 24 to 110 VDC (Operating voltage: 16.8 to 137.5 VDC)**

High-performance 10Gbps Ethernet Capability

Some models in the ITS-6326 series include **two 10G M12 ports** and **two Q-ODC slots**, designed with a high-performance switch architecture that provides non-blocking switch fabric and wire-speed throughput of up to **112Gbps**. This robust capability effectively simplifies LAN upgrades to accommodate increasing bandwidth demands.

Each 10G M12 port supports four transmission speeds: **1GBASE-T**, **2.5GBASE-T**, **5GBASE-T**, and **10GBASE-T**, offering administrators the flexibility to choose the appropriate speed for efficient network expansion. Additionally, the 10G Q-ODC slots exclusively accommodate **10GBASE-SR/LR** single-mode fiber transceivers. Engineered for reliability in challenging conditions, it serves as the ideal solution for railway on-board and trackside applications, as well as for vehicles and other demanding industrial environments.

High Power PoE for Security and Public S+ervice Applications

As the whole system comes up to a total **100-watt PoE budget**, this series is designed specifically to fulfill the growing demand of higher power consuming network PDs (powered devices) such as multi-channel (802.11a/b/g/n) wireless LAN access points, PTZ (pan, tilt, zoom) speed dome network cameras and other PoE network devices.

Optional Bypass Relay Prevents Link Failure During Power Loss

The bypass relay is designed to bypass the failed switch to the next normal switch to prevent the network from power loss. Some models in this series support the bypass relay function on a pair of 10 Gigabit ports. When the switch is functioning normally, the 10 Gigabit ports operate like the other ports, processing and forwarding Ethernet packets. In the event of a power outage, the bypass relay ports ensure that network traffic continues to flow uninterrupted. Once power is restored and the switch has fully booted up, the system can revert to the normal mode, thus preventing further network disruptions.

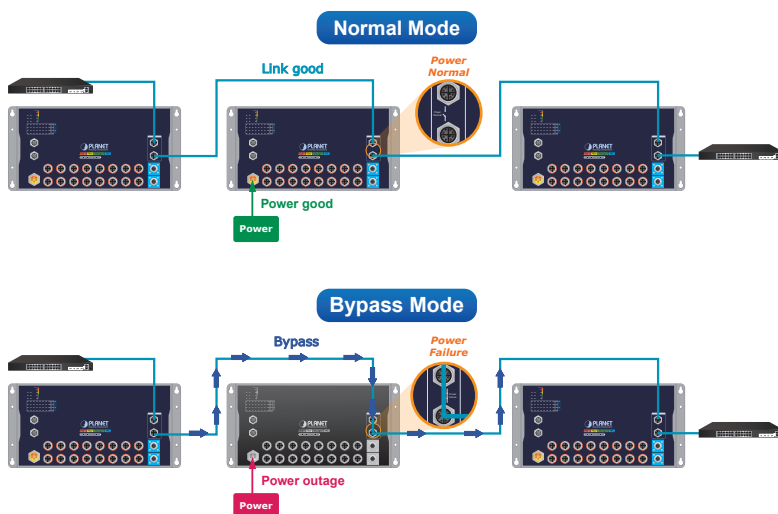

Redundant Ring, Fast Recovery for Critical Network Applications

The ITS-6326 series supports redundant ring technology and features robust, rapid self-recovery capabilities to prevent interruptions and external intrusions. It incorporates the advanced **ITU-T G.8032 ERPS (Ethernet Ring Protection Switching)** technology,

Industrial Case and Installation

- IP40 metal case
- Wall-mount design
- Dual DC input
 - Overload current protection
 - Reverse polarity protection
- -40 to 70 degrees C operating temperature

Power over Ethernet

- Complies with IEEE 802.3at Power over Ethernet Plus, end-span PSE.
- Power up to 8/16 IEEE 802.3at devices.
- Supports PoE power up to 36 watts for each PoE port.
- Auto detects powered device (PD).
- Circuit protection prevents power interference between ports.
- Remote power feeding up to 100m in standard mode and 250m in extended mode
- PoE management features
 - Total PoE power budget control
 - Per port PoE function enable/disable
 - PoE admin-mode control
 - PoE port power feeding priority
 - Per PoE port power limitation
 - PD classification detection
 - PoE extension
- Intelligent PoE features
 - Temperature threshold control
 - PoE usage threshold control
 - PD alive check
 - PoE schedule
 - PD recycling schedule

Industrial Protocol

- Modbus TCP for real-time monitoring in the SCADA system
- Supports IEEE 1588v2 PTP (Precision Time Protocol) transparent clock mode.

Digital Input and Digital Output

- One digital input (DI)
- One digital output (DO)
- Integrate sensors into auto alarm system.
- Transfer alarm to IP network via SNMP trap.

Layer 3 IP Routing Features

- Supports maximum 128 static routes and route summarization.
- IPv4 dynamic routing protocol supports RIPv2 and OSPFv2.
- IPv6 dynamic routing protocol supports OSPFv3.
- IPv4/IPv6 hardware static routing
- Routing interface provides per VLAN routing mode.

Spanning Tree Protocol (802.1s MSTP), and **dual power** input into an industrial automation network to enhance system reliability and uptime in harsh factory environments. In a simple ring network, the recovery time of data link can be as fast as 10ms.



Cybersecurity Network Solution to Minimize Security Risks

The industrial managed switch supports SSHv2, TLS and SSL protocols to provide strong protection against advanced threats. In addition, it includes a range of cybersecurity features such as **DHCP Snooping, IP Source Guard, ARP Inspection Protection, 802.1x port-based** and **MAC-based** network access control, RADIUS and TACACS+ user accounts management, SNMPv3 authentication, and so on to complement it as an all-security solution.



Layer 3 Routing Support

The ITS-6326 series empowers administrators to enhance network efficiency by manually configuring Layer 3 IPv4/IPv6 VLAN static routing or automatically setting up RIP (Routing Information Protocol) and OSPF (Open Shortest Path First). The RIP uses hop count as a routing metric and prevents routing loops by limiting the number of hops permitted in a path from source to destination. The OSPF, a dynamic interior routing protocol for autonomous systems, operates based on link-state information. It builds a link-state database through the exchange of link-state data among Layer 3 switches and applies the Shortest Path First algorithm to generate a route table from this database.

Robust Layer 2 Features

The ITS-6326 series can be programmed for advanced switch management functions such as dynamic port link aggregation, 802.1Q VLAN and Q-in-Q VLAN, Multiple Spanning Tree protocol (MSTP), loop and BPDU guard, IGMP snooping, and MLD snooping. Via the link aggregation, the ITS-6326 series allows the operation of a high-speed trunk to combine with multiple ports, and supports fail-over as well. Also, the Link Layer Discovery Protocol (LLDP) is the Layer 2 protocol included to help discover basic information about neighboring devices on the local broadcast domain.

Layer 2 Features

- Prevents packet loss with back pressure (half-duplex) and IEEE 802.3x pause frame flow control (full-duplex).
- High performance of Store-and-Forward architecture, and runt/CRC filtering eliminates erroneous packets to optimize the network bandwidth.
- Storm Control support
 - Broadcast/Multicast/Unicast
- Supports **VLAN**
 - IEEE 802.1Q tagged VLAN
 - UP to 4K VLANs groups, out of 4094 VLAN IDs
 - Provider Bridging (VLAN Q-in-Q) support (IEEE 802.1ad)
 - Private VLAN Edge (PVE)
 - Protocol-based VLAN
 - MAC-based VLAN
 - Voice VLAN
 - GVRP (GARP VLAN Registration Protocol)
- Supports **Spanning Tree Protocol**
 - IEEE 802.1D Spanning Tree Protocol (STP)
 - IEEE 802.1w Rapid Spanning Tree Protocol (RSTP)
 - IEEE 802.1s Multiple Spanning Tree Protocol (MSTP), spanning tree by VLAN
 - BPDU Guard
- Supports **Link Aggregation**
 - IEEE 802.3ad Link Aggregation Control Protocol (LACP)
 - Cisco ether-channel (Static Trunk)
 - Maximum 10 trunk groups with 20 ports per trunk group
 - Up to 8Gbps bandwidth (duplex mode)
- Provides port mirror (many-to-1)
- Loop protection to avoid broadcast loops
- Supports ERPS (Ethernet Ring Protection Switching)
- Compatible with Cisco **Uni-directional link detection** (UDLD) that monitors a link between two switches and blocks the ports on both ends of the link if the link fails at any point between the two devices
- Link Layer Discovery Protocol (LLDP)

Quality of Service

- Ingress Shaper and Egress Rate Limit per port bandwidth control
- 8 priority queues on all switch ports
- Traffic classification
 - IEEE 802.1p CoS
 - IP TOS/DSCP/IP precedence
 - IP TCP/UDP port number
 - Typical network application
- Strict priority and Weighted Round Robin (WRR) CoS policies
- Supports QoS and In/Out bandwidth control on each port
- Traffic-policing on the switch port
- DSCP remarking

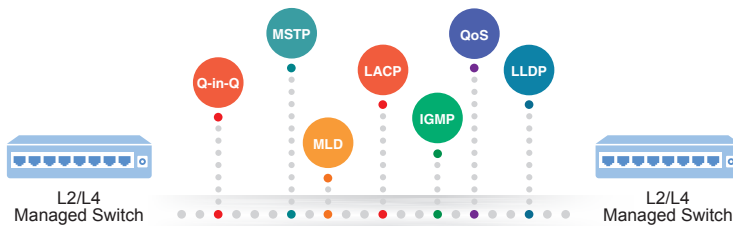

User-friendly Management Interfaces

For efficient management, this series is equipped with **console**, **Web** and **SNMP** management interfaces.

- With the built-in **Web-based** management interface, the ITS-6326 series offers an easy-to-use, platform-independent management and configuration facility.
- For **text-based** management, the switches can be accessed via Telnet and the console port.
- For standard-based monitor and management software, it offers SNMPv3 connection which encrypts the packet content at each session for secure remote management.

Moreover, the ITS-6326 PoE Series offers secure remote management by supporting **SSHv2**, **TLSv1.2** and **SNMP v3** connections which encrypt the packet content at each session.

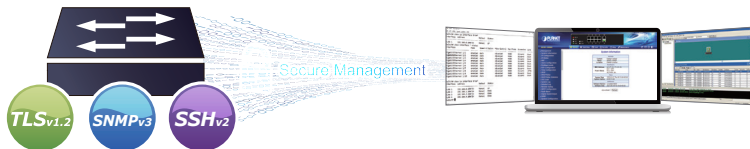

IPv6/IPv4 Dual Stack Management

Supporting both IPv6 and IPv4 protocols, the ITS-6326 series helps the SMBs to step in the IPv6 era with the lowest investment as its network facilities need not be replaced or overhauled if the IPv6 FTTx edge network is set up.

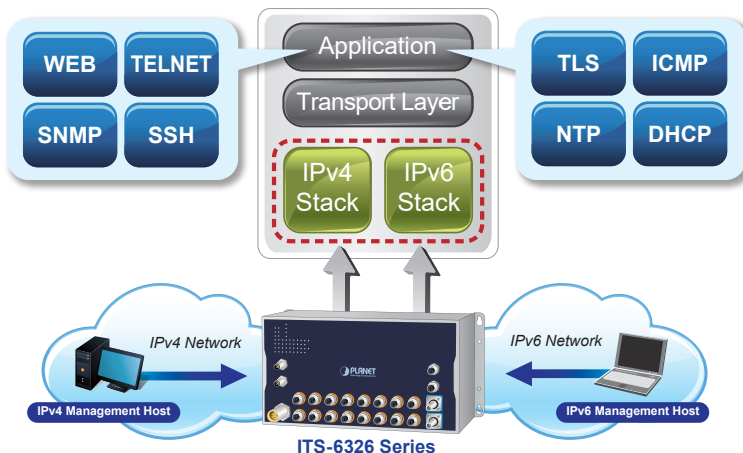

Powerful Security

Offering comprehensive Layer 2 to Layer 4 Access Control List (ACL) features for enforcing security at the edge, it can restrict network access by denying packets based on source and destination IP addresses, TCP/UDP ports, or predefined typical network

Multicast

- Supports IPv4 IGMP snooping v1, v2 and v3
- Supports IPv6 MLD snooping v1 and v2
- Querier mode support
- IPv4 IGMP snooping port filtering
- IPv6 MLD snooping port filtering
- MVR (Multicast VLAN Registration)

Security

- Storm Control support
 - Broadcast / Multicast / Unknown Unicast
- Authentication
 - Built-in RADIUS client to co-operate with the RADIUS servers
 - DHCP Option 82
 - RADIUS/TACACS+ login user access authentication
- Access Control List
 - IPv4/IPv6 IP-based ACL
 - IPv4/IPv6 IP-based ACE
 - MAC-based ACL
 - MAC-based ACE
- MAC Security
 - Static MAC
 - MAC Filtering
- Port Security for Source MAC address entries filtering
- DHCP Snooping to filter distrusted DHCP messages
- Dynamic ARP Inspection discards ARP packets with invalid MAC address to IP address binding
- IP Source Guard prevents IP spoofing attacks
- DoS Attack Prevention

Management

- IPv4 and IPv6 dual stack management
- Switch Management Interfaces
 - Console/Telnet Command Line Interface
 - Web switch management
 - SNMP v1 and v2c and v3 switch management
 - SSHv2, TLSv1.2 secure access
- SNMP Management
 - Four RMON groups (history, statistics, alarms, and events)
 - SNMP trap for interface Link Up and Link Down notification
- IPv6 IP address/NTP/DNS management
- Built-in Trivial File Transfer Protocol (TFTP) client
- BOOTP and DHCP for IP address assignment
- System Maintenance
 - Firmware upload/download via HTTP/TFTP
 - Reset button for system reboot or reset to factory default
 - Dual Images
- DHCP Functions:
 - DHCP Relay

applications. Its protection mechanism also includes 802.1x port-based and MAC-based user and device authentication. With the private VLAN function, communication between edge ports is prevented, ensuring user privacy. Network administrators can now build highly secure corporate networks with significantly less time and effort than before.

1588 Time Protocol for Industrial Computing Networks

The ITS-6326 series is ideal for telecom and Carrier Ethernet applications, supporting MEF service delivery and timing over packet solutions for IEEE 1588 and synchronous Ethernet.

Time Synchronization in Network

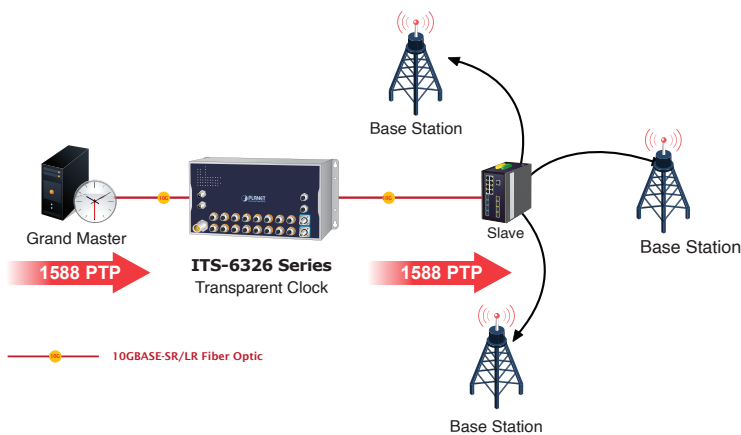

Modbus TCP Provides Flexible Network Connectivity for Factory Automation

With the supported Modbus TCP/IP protocol, the ITS-6326 series can easily integrate with SCADA systems, HMI systems and other data acquisition systems in factory floors. It enables administrators to remotely monitor the industrial Ethernet switch's **operating information, port information and communication status**, thus easily achieving enhanced monitoring and maintenance of the entire factory.

SMTP/SNMP Trap Event Alert

The ITS-6326 series provides event alert function to help to diagnose the abnormal device owing to whether or not there is a break of the network connection, or the rebooting response.

SMTP/SNMP Trap Event Alert

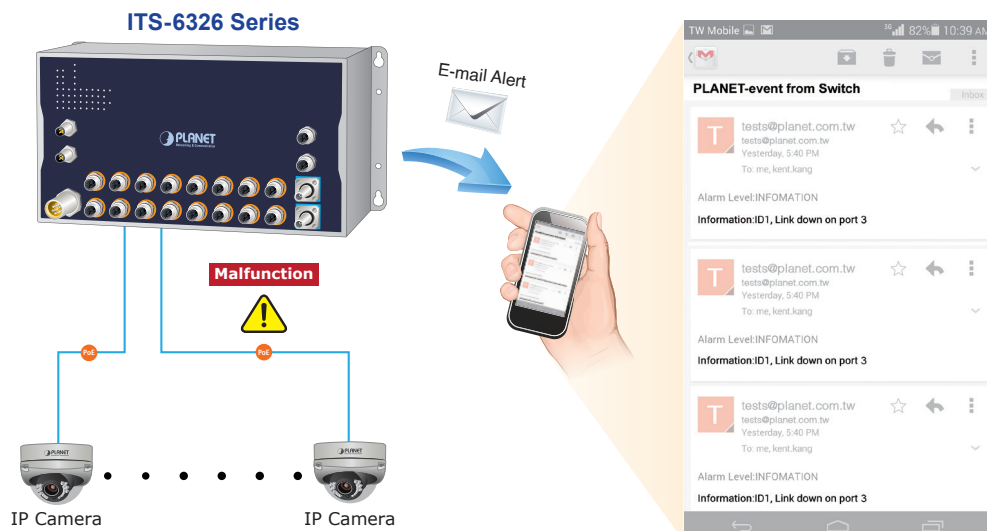

- DHCP Option 82
- DHCP Server
- User Privilege levels control
- Network Time Protocol (NTP)
- Network Diagnostics
 - SFP-DDM (Digital Diagnostic Monitor)
 - ICMPv6/ICMPv4 remote ping
 - Cable diagnostic technology provides the mechanism to detect and report potential cabling issues.
- PLANET NMS System and Smart Discovery Utility for deployment management
- SMTP/Syslog remote alarm
- Event message logging to remote syslog server
- PLANET Smart Discovery Utility for deployment management
- Provides ONVIF for co-operating with PLANET video IP surveillances.
- PLANET NMS system and NMSViewerPro/CloudViewerPro app for deployment management.

Intelligent SFP Diagnosis Mechanism

The ITS-6326 series supports **SFP-DDM (Digital Diagnostic Monitor)** function that greatly helps network administrator to easily monitor real-time parameters of the SFP+ transceivers, such as optical output power, optical input power, temperature, laser bias current, and transceiver supply voltage.

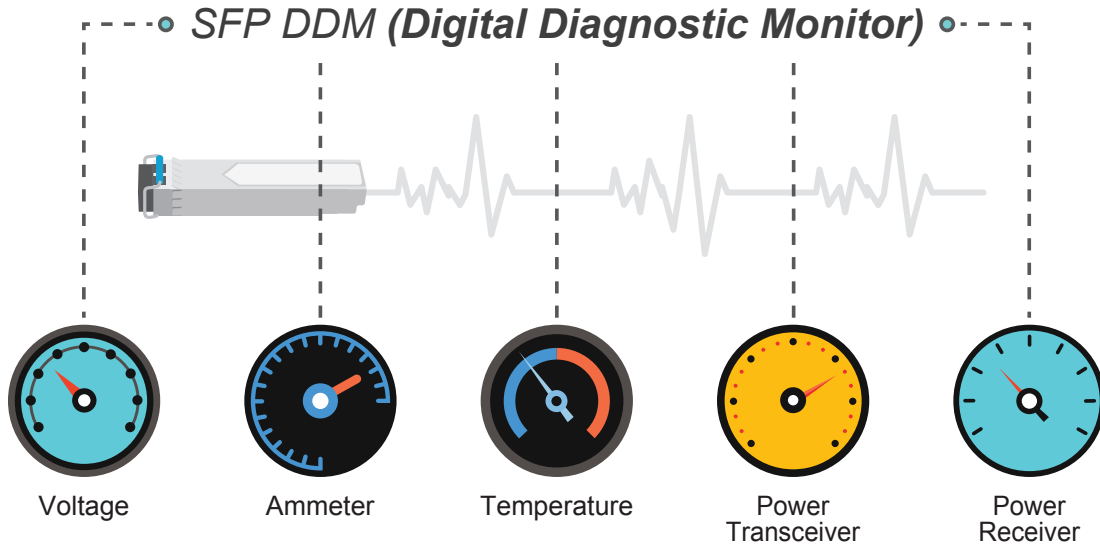

Convenient and Smart ONVIF Devices with Detection Feature

PLANET has newly developed an awesome feature -- ONVIF Support -- which is specifically designed for co-operating with video IP surveillances. From the ITS-6326 series GUI, clients just need one click to search and show all of the ONVIF devices via network application. In addition, clients can upload floor images to the switch series, making the deployments of surveillance and other devices easy for planning and inspection purposes. Moreover, clients can get real-time surveillance's information and online/offline status; the PoE reboot can be controlled from the GUI.

Add to ONVIF Device List

ONVIF Switch ITS-6326 Series

eMap of ONVIF IP Camera Monitoring

IP Camera IP Camera IP Camera NVR

ONVIF Device

Intelligent Alive Check for Powered Device

The ITS-6326 series can be configured to monitor connected PD (powered device) status in real time via ping action. Once the PD stops working and responding, the ITS-6326 Series will resume the PoE port power and bring the PD back to work. It will greatly enhance the network reliability through the PoE port resetting the PD's power source and reducing the administrator's management burden.

PD Alive Check

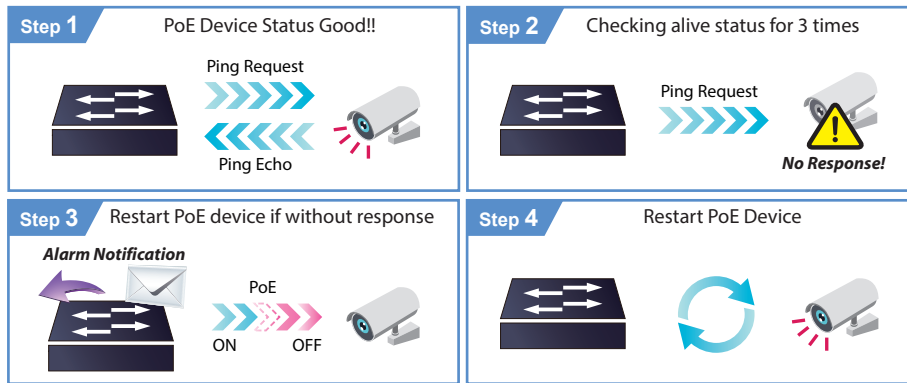

PoE Schedule for Energy Savings

In response to the global trend of energy conservation and environmental protection, the ITS-6326 series effectively manages power supply while delivering high wattage. The built-in "PoE schedule" function allows users to enable or disable PoE power feeding for each port during specified time intervals. This feature is particularly beneficial for small- to medium-sized businesses (SMBs) and enterprises, helping them save both energy and costs. The ITS-6326 series enables each connected PoE IP camera or PoE wireless access point to reboot at a designated time each week. This functionality helps minimize the risk of crashes caused by buffer overflow in IP cameras or access points.

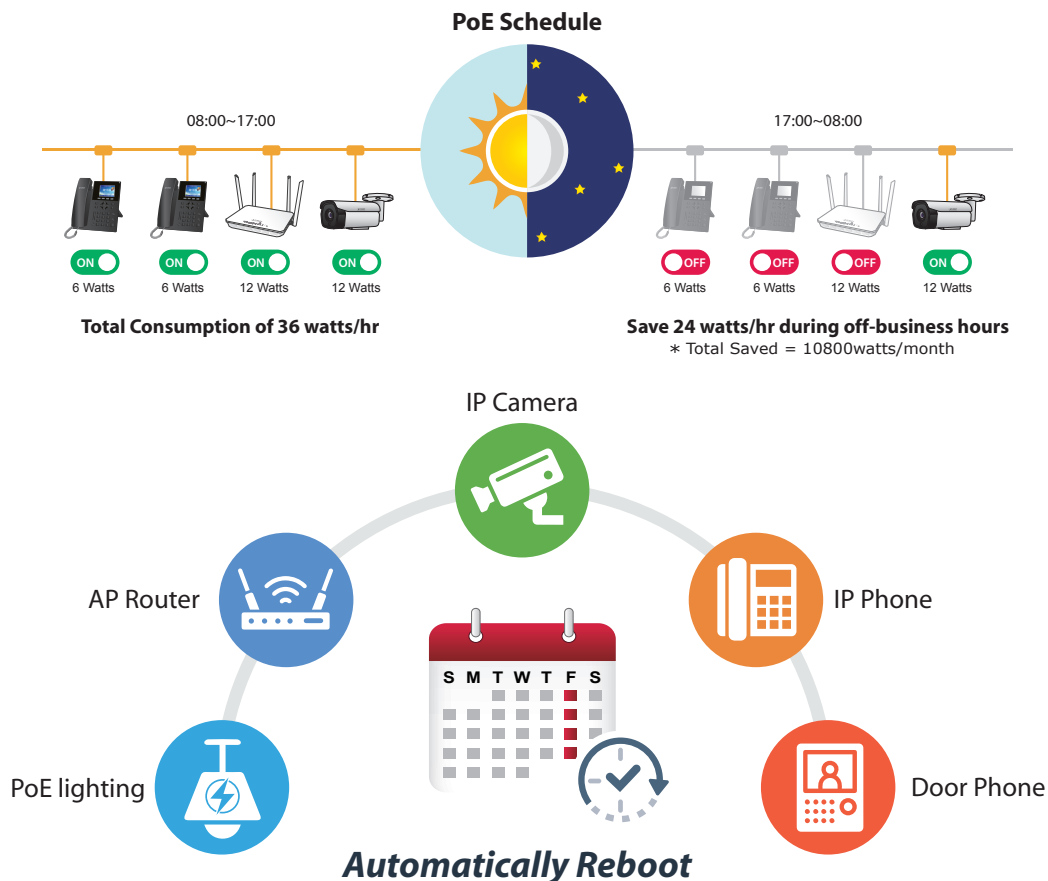

802.3at PoE+ Power and Ethernet Data Transmission Distance Extension

In the “**Extend**” operation mode, the ITS-6326 series functions on a per-port basis at 10 Mbps in duplex mode, while also supporting a 20-watt PoE output over distances of up to 250 meters, effectively surpassing the standard 100-meter limit of Ethernet UTP cables. This innovative feature offers an additional solution for extending the distance of 802.3at PoE, thereby reducing the costs associated with Ethernet cable installation.

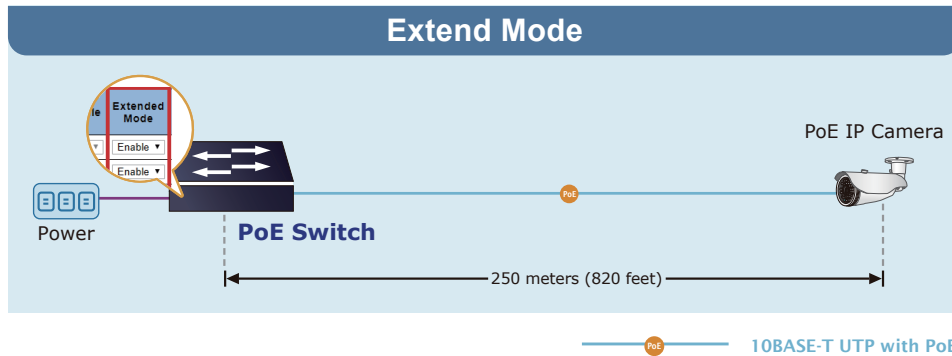

Digital Input and Digital Output for External Alarm

This external alarm system enables users to utilize a Digital Input to monitor and log the status of external devices, such as door intrusion detectors, and send event alarms to administrators. The Digital Output can be used to alarm administrators of any changes in link status, whether the link is down or up, on the ITS-6326 series port.

Digital Input



Digital Output

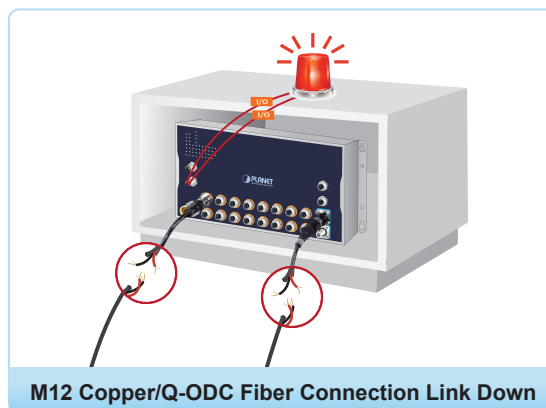

Effective Alarm Alert for Better Protection

The ITS-6326 series includes a Fault Alarm feature that promptly alerts users to any issues with the switches. This valuable functionality eliminates the need for users to spend time identifying the problem, resulting in significant savings in both time and human resources.

Fault Alarm Feature

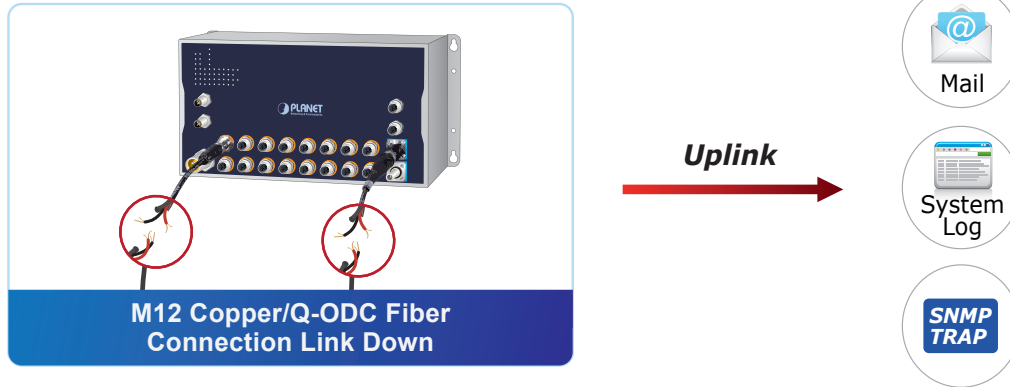

Remote Management Solution

PLANET's **Universal Network Management System (UNI-NMS)**, **NMSViewerPro**, and **CloudViewerPro** applications offer comprehensive support for IT staff in effectively managing and monitoring all network devices, including the ITS-6326 series, from remote locations. Designed for deployment in both enterprise and industrial environments where the ITS-6326 series is used remotely, these systems facilitate the identification of bugs or faulty conditions without the necessity of on-site visits. With PLANET's Remote Management Solution, businesses of all types can now be managed swiftly and efficiently through a unified platform, enhancing operational oversight.



Applications

Designed for Industrial and Transportation Applications

Providing up to 16 PoE+ in-line power interfaces, the ITS-6326 series can easily build a power system to centrally control IP phone systems, IP camera systems, or wireless APs in industrial and transportation environments.

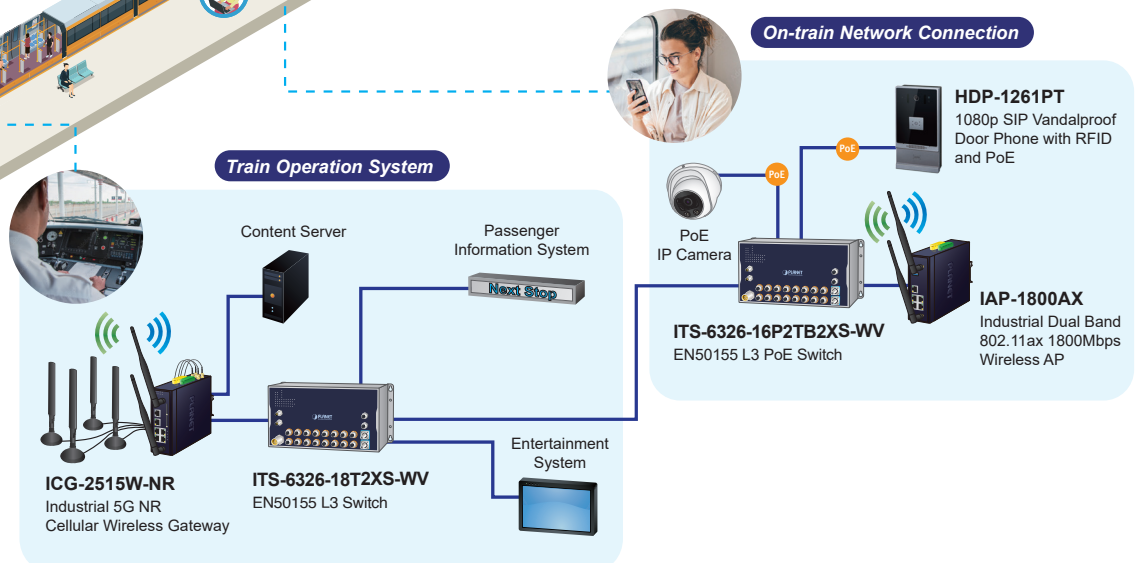
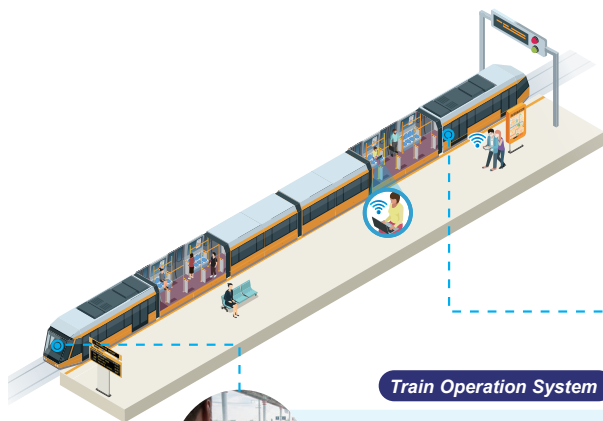
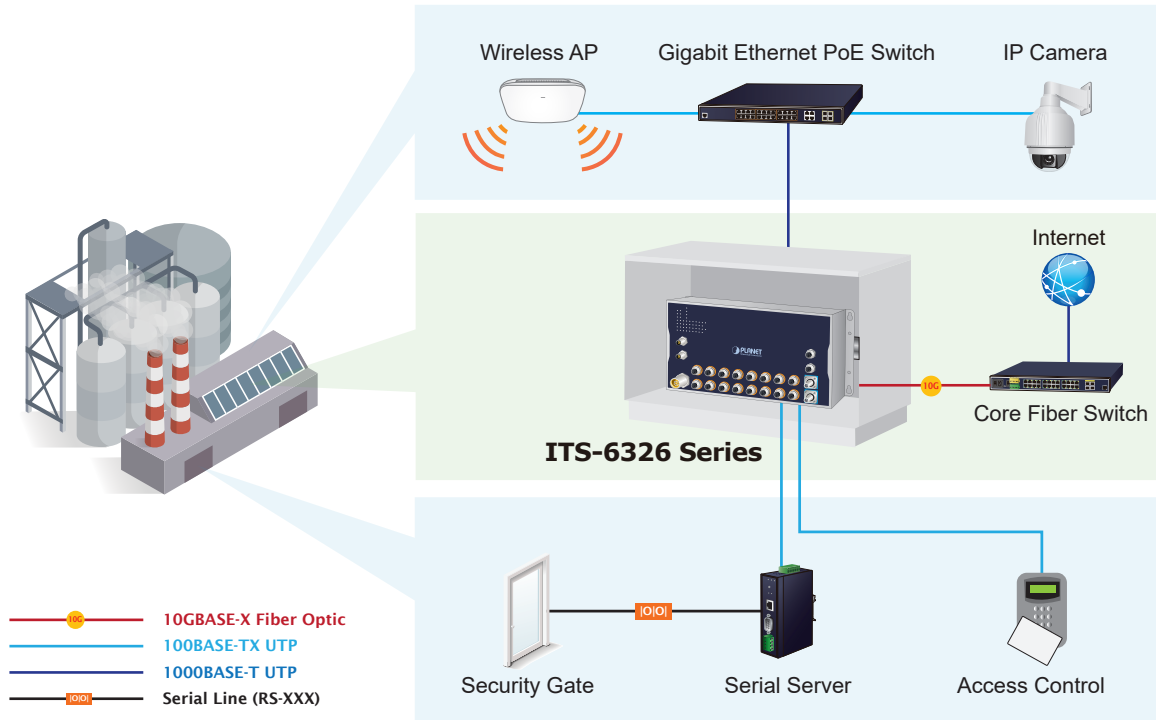

Bypass Relay Solution for Daisy Chain Topology

In a daisy chain topology, a single failed node can disrupt the links of other switches. In railway communication systems with interconnected networks, a failed upstream link in one train car will impact the downstream link in other train cars. To prevent such failures, the ITS-6326 series, equipped with a bypass function, offers two ports with a bypass relay feature. If one of the switches experiences a power loss, the other ports of the switch will bypass the failed relay circuit, allowing network traffic to continue flowing smoothly and ensuring continuous system operation.

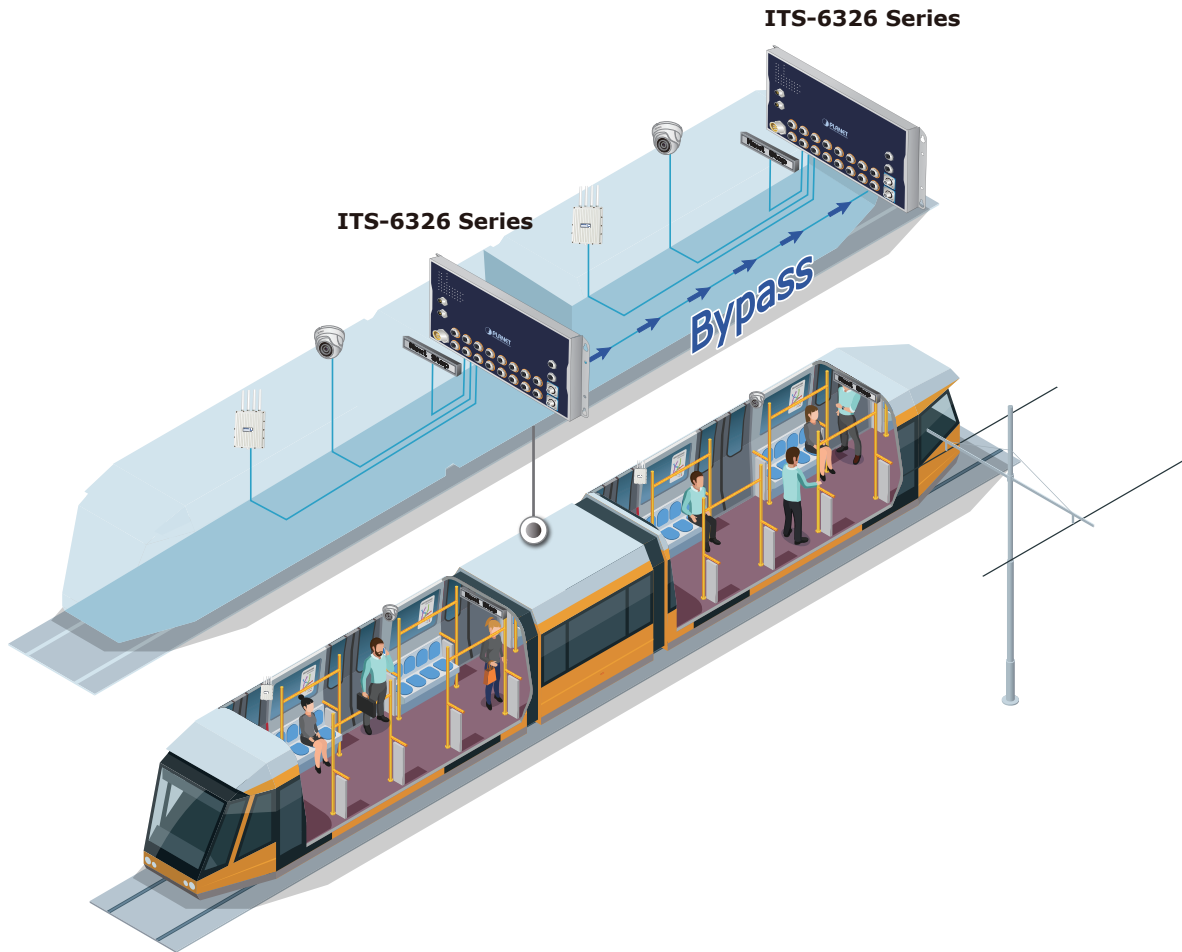

Specifications

Product	ITS-6326-16P2TB2XS-WV	ITS-6326-16P2T2XS-WV	ITS-6326-8P10T2XS-WV
Hardware Specifications			
Copper Ports, M12, 8-pin X-coded Female Connector	16 x 10/100/1000BASE-T (Ports 1 to 16)		2 x 10GBASE-T (Ports 17 to 18) Supports 10G/ 5G/ 2.5G/ 1G/ 100Mbps data rate
Copper Ports, M12, 8-pin X-coded Female Connector with Bypass Relay	2 x 10GBASE-T (Ports 17 to 18) Supports 10G/5G/2.5G/1G/ 100Mbps data rate		-
PoE Injector Port	16 ports with 802.3at PoE+ injector function (Ports 1 to 16)		8 ports with 802.3at PoE+ injector function (Ports 1 to 8)
Q-ODC Fiber Ports	2 x 10GBASE-X with single-mode fiber (Ports 19 to 20)		
Console	USB Data to RS232 serial port (115200, 8, N, 1) 1 x M12 A-coded 5-pin male connector		
Reset Button	< 5 sec.: System reboot > 5 sec.: Factory default		
Alarm & DI & DO Ports	1 x M12 A-coded 5-pin male connector for DI/DO and alarm interface - Pin 1 for DI and Pin 2 for DO - Pin 3/4 for Alarm - Pin 5 for GND		
Alarm	One relay output for port breakdown and power failure. Alarm relay current carry ability: 1A @ 24V DC		
Digital Input (DI)	One digital input (DI) - Level 0: -24V~2.1V (±0.1V) - Level 1: 2.1V~24V (±0.1V) - Input load to 24V DC, 10mA max.		
Digital Output (DO)	One digital output (DO) - Open collector to 24V DC, 100mA max.		
Power Connector	1 x M23 A-coded 5-pin male connector		
Number of Power Input	2		
Power Input	24 to 110 VDC		
Operation Voltage	16.8 to 137.5 VDC		
Power Consumption/ Dissipation excludes PoE Load	Max. 36.04 watts / 122.97 BTU (system on) Max. 43.57 watts / 147.47 BTU (Full loading)		
LED	System: PWR1 (Green) PWR2 (Green) Alarm (Red) Ring (Green) R.O. (Green) I/O (Red) 10/100/1000T M12 Ports: Up: 1000 LNK/ACT (Green) 10/100 LNK/ACT (Amber) 10/100/1000T M12 PoE+ Ports: Up: 1000 LNK/ACT (Green) 10/100 LNK/ACT (Amber) Down: PoE-in-Use (Amber) 100/1G/2.5G/5G/10GBASE-T M12 Ports: Up: 1000 LNK/ACT (Green) 100/10G LNK/ACT (Amber) Down: 2.5G/5G LNK/ACT (Amber) 10GBASE-X Q-ODC Fiber Port: Up: LNK/ACT (Amber)		
Enclosure	IP40 aluminum case		
Installation	Wall-mount design		
Dimensions (W x D x H)	400 x 74 x 195 mm		
Weight	4700 g		
Power over Ethernet			
PoE Standard	IEEE 802.3at Power over Ethernet Plus PSE		
PoE Power Supply Type	End-span		
PoE Power Output	IEEE 802.3at Standard - Per port 54V DC, max. 36 watts		

Power Pin Assignment	1/2(+), 3/6(-)
Power Budget	80 watts, Power Input <= 36V DC 100 watts, Power Input > 36V DC
PoE Management Functions	
Enhanced PoE Mode	Standard/ Legacy/ Force
PoE Management	PD Alive Check Scheduled Power Recycling PoE Schedule PoE Usage Monitoring PoE Extension
Active PoE Device Live Detection	Yes
PoE Power Recycling	Yes, daily or predefined schedule
PoE Schedule	4 schedule profiles
PoE Extend Mode	Yes, max. up to 250 meters
Switching Specifications	
Switch Architecture	Store-and-forward
Switch Fabric	112Gbps/non-blocking
Switch Throughput@64Bytes	83.3Mpps @64Bytes
Address Table	16K entries, automatic source address learning and aging
Shared Data Buffer	32M bits
Flow Control	IEEE 802.3x pause frame for full duplex Back pressure for half duplex
Jumbo Frame	10K Bytes
Layer 3 Functions	
IP Interfaces	Max. 128 VLAN interfaces
Routing Table	Max. 128 routing entries Max. 4K H/W routing table entries
Routing Protocols	IPv4 hardware static routing IPv6 hardware static routing IPv4 RIPv2 IPv4 OSPFv2 dynamic routing IPv6 OSPFv3 dynamic routing
Layer 2 Functions	
Port Configuration	Port disable/enable Auto-negotiation 10/100/1000Mbps full and half duplex mode selection Flow control disable/enable Power saving mode control
Port Status	Display each port's speed duplex mode, link status, flow control status, auto negotiation status, trunk status
Port Mirroring	TX / RX / Both Many-to-1 monitor RMirror – Remote Switched Port Analyzer (Cisco RSPAN) Supports up to 5 sessions
VLAN	IEEE 802.1Q tag-based VLAN, up to 255 VLAN groups IEEE 802.1ad Q-in-Q tunneling Private VLAN Edge (PVE) MAC-based VLAN Protocol-based VLAN Voice VLAN MVR (Multicast VLAN Registration) GVRP (GARP VLAN Registration Protocol) Up to 4K VLAN groups, out of 4094 VLAN IDs
Link Aggregation	IEEE 802.3ad LACP/Static Trunk Supports - Static Port Trunking, (20 ports/10 groups max.) - Dynamic LACP-(20 ports/10 groups max.)
Spanning Tree Protocol	IEEE 802.1D Spanning Tree Protocol (STP) IEEE 802.1w Rapid Spanning Tree Protocol (RSTP) IEEE 802.1s Multiple Spanning Tree Protocol (MSTP) BPDU Guard
IGMP Snooping	IPv4 IGMP (v1/v2/v3) snooping, up to 255 multicast groups IPv4 IGMP querier mode support IPv4 IGMP Snooping port filtering Multicast VLAN Registration

MLD Snooping	IPv6 MLD (v1/v2) snooping, up to 255 multicast groups IPv6 MLD querier mode support
Bandwidth Control	Per port bandwidth control - Ingress: 500Kb~1000Mbps - Egress: 500Kb~1000Mbps
Ring	Support ERPS, complies with ITU-T G.8032v1 and v2 Recovery time < 50ms
Synchronization	IEEE 1588v2 PTP(Precision Time Protocol) - Peer-to-peer transparent clock - End-to-end transparent clock
QoS	Traffic classification based, strict priority and WRR 8-level priority for switching - Port number - 802.1p priority - 802.1Q VLAN tag - DSCP/TOS field in IP packet
Security Functions	
Access Control List	IP-based ACL/MAC-based ACL ACL based on: - MAC Address - IP Address - Ethertype - Protocol Type - VLAN ID - DSCP - 802.1p Priority Up to 512 entries
Security	Port security IP source guard, up to 512 entries Dynamic ARP inspection, up to 1K entries Command line authority control based on user level Static MAC address, up to 64 entries
AAA	RADIUS client TACACS+ client
Network Access Control	IEEE 802.1x port-based network access control MAC-based authentication Local/RADIUS authentication
Management Functions	
Basic Management Interfaces	Console/ Telnet/ Web browser/ SNMP v1, v2c
Secure Management Interfaces	SSHv2, TLS v1.2, SNMP v3
System Management	Firmware upgrade by HTTP/TFTP protocol through Ethernet network LLDP protocol NTP PLANET Smart Discovery Utility PLANET NMS System, NMSViewerPro and CloudViewerPro App
Event Management	Remote Syslog System log SMTP
ONVIF	ONVIF device discovery ONVIF device monitoring Floor map

SNMP MIBs	<p>RFC 1213 MIB-II RFC 2863 IF-MIB RFC 1493 Bridge MIB RFC 1643 Ethernet MIB RFC 2863 Interface MIB RFC 2665 Ether-Like MIB RFC 2819 RMON MIB (Groups 1, 2, 3 and 9) RFC 2737 Entity MIB RFC 2618 RADIUS Client MIB RFC 2933 IGMP-STD-MIB RFC 3411 SNMP-Frameworks-MIB RFC 4836 MAU-MIB IEEE 802.1X PAE LLDP RFC 4292 IP Forward MIB RFC 4293 IP MIB</p>
Standards Conformance	
Regulatory Compliance EMI & EMS	<p>FCC Part 15 Class A Planning: CE: EN 55032, EN 55035 EN 61000-6-2, EN 61000-6-4</p>
Stability Testing	<p>IEC60068-2-32 (free fall) IEC60068-2-27 (shock) IEC60068-2-6 (vibration) Planning: IEC 61373, EN 50155 (Shock) IEC 61373, EN 50155 (Vibration)</p>
Railway (Planning)	EN 50155, EN50121-4, IEC 60571
Railway Fire Protection (Planning)	EN 45545-2
Standards Compliance	<p>IEEE 802.3 10BASE-T IEEE 802.3u 100BASE-TX/100BASE-FX IEEE 802.3z Gigabit SX/LX IEEE 802.3ab Gigabit 1000T IEEE 802.3ae 10GBASE-X IEEE 802.3an 10GBASE-T IEEE 802.3bz 2.5/5GBASE-T IEEE 802.3x flow control and back pressure IEEE 802.3ad port trunk with LACP IEEE 802.1D Spanning Tree Protocol IEEE 802.1w Rapid Spanning Tree Protocol IEEE 802.1s Multiple Spanning Tree Protocol IEEE 802.1p Class of Service IEEE 802.1Q VLAN tagging IEEE 802.1ad Q-in-Q VLAN stacking IEEE 802.1X Port Authentication Network Control IEEE 802.1ab LLDP IEEE 802.3at Power over Ethernet Plus IEEE 802.3ah OAM IEEE 802.1ag Connectivity Fault Management(CFM) IEEE 802.3az Energy Efficient Ethernet (EEE) IEEE 1588 PTPv2 RFC 768 UDP RFC 783 TFTP RFC 791 IP RFC 792 ICMP RFC 2068 HTTP RFC 1112 IGMP v1 RFC 2236 IGMP v2 RFC 3376 IGMP version 3 RFC 2710 MLD version 1 RFC 3810 MLD version 2 ITU G.8032 ERPS Ring ITU-T G.8032 ERPS Ring ITU-T Y.1731 Performance Monitoring</p>

Environment

Operating	Temperature: -40 ~ 70 degrees C Relative Humidity: 5 ~ 95% (non-condensing)
Storage	Temperature: -40 ~ 85 degrees C Relative Humidity: 5 ~ 95% (non-condensing)

Dimensions

■ ITS-6326-16P2TB2XS-WV

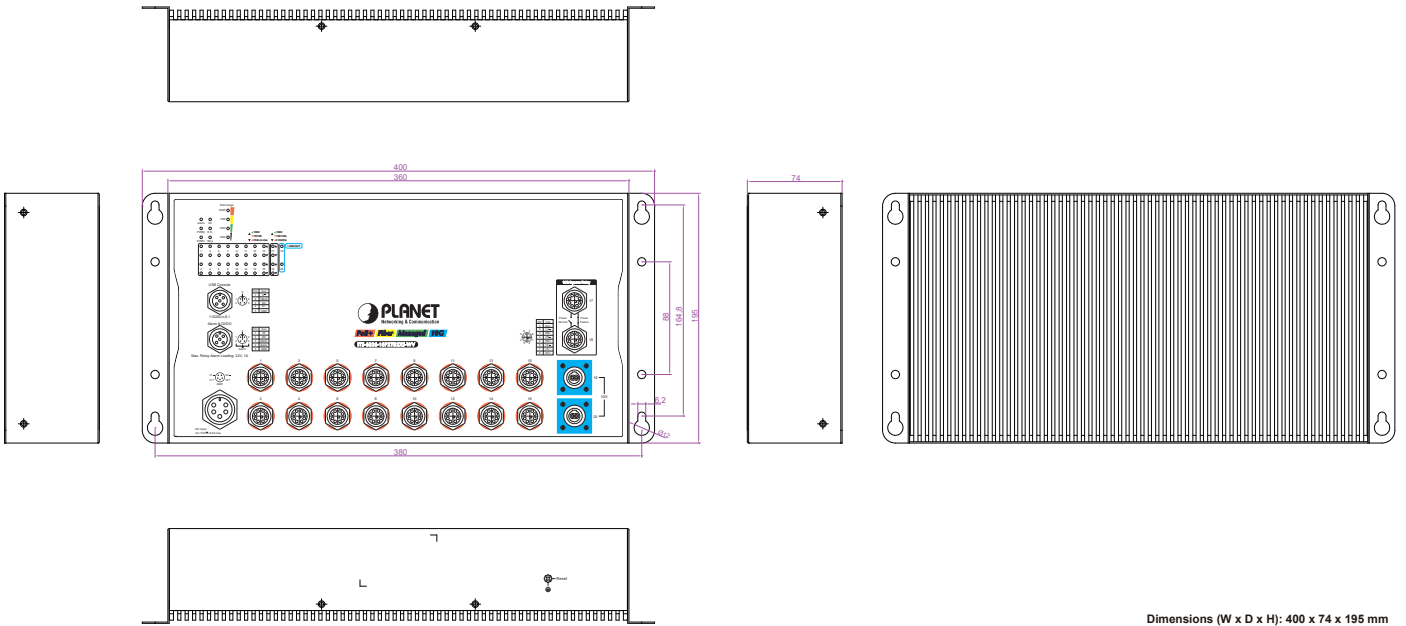

Dimensions (W x D x H): 400 x 74 x 195 mm

■ ITS-6326-16P2T2XS-WV

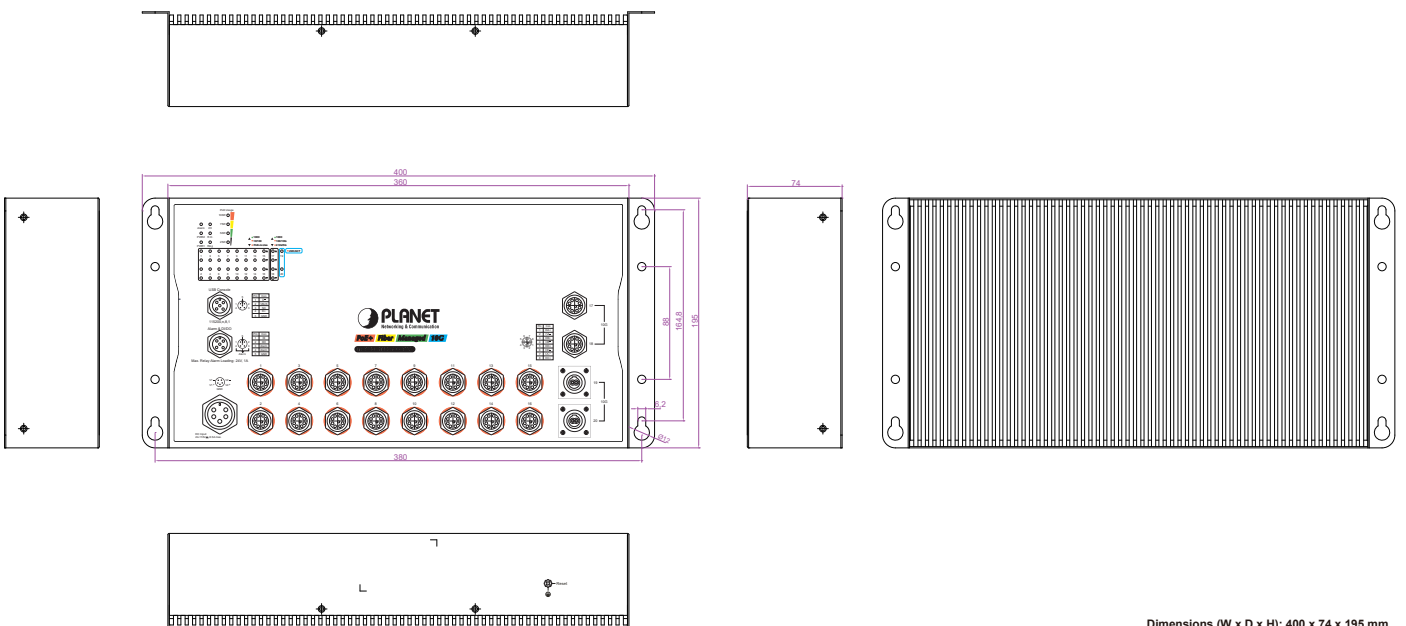

Dimensions (W x D x H): 400 x 74 x 195 mm

■ ITS-6326-8P10T2XS-WV

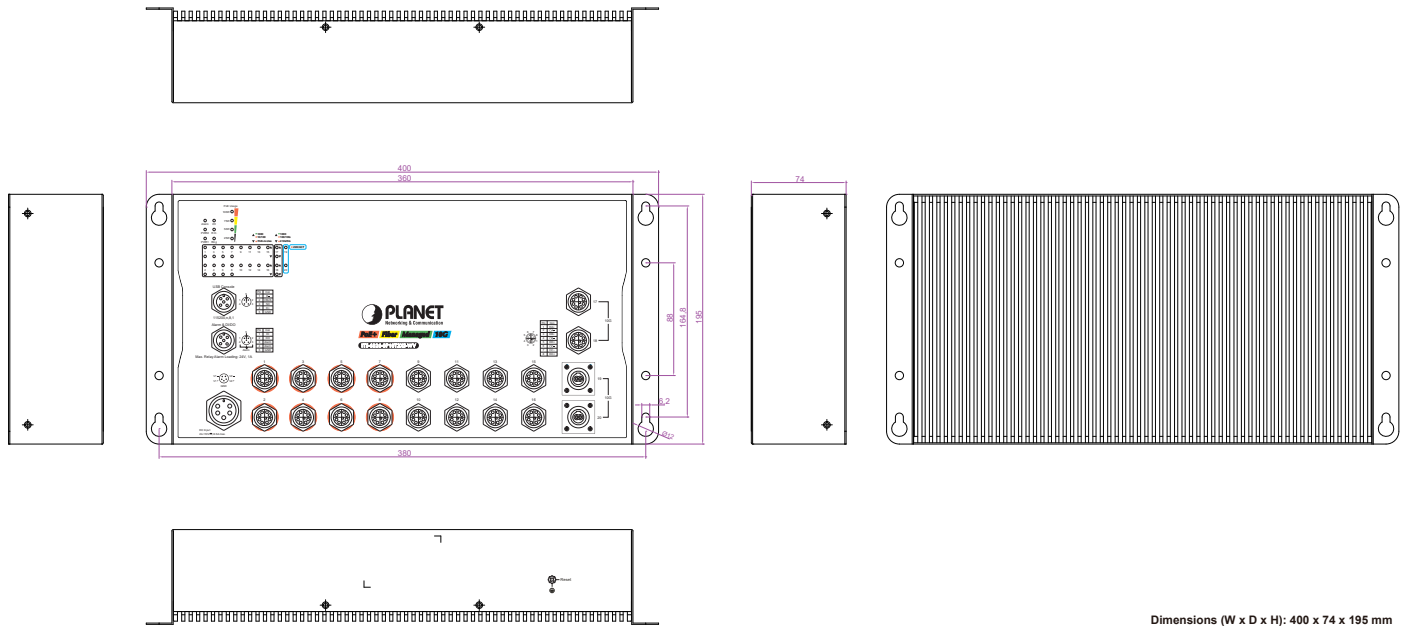

Dimensions (W x D x H): 400 x 74 x 195 mm

Ordering Information

ITS-6326-16P2TB2XS-WV	Industrial L3 16-Port 10/100/1000T 802.3at PoE+ M12 + 2-Port 10GBASE-T M12 Bypass + 2-Port 10G Q-ODC Managed Ethernet Switch with dual wide voltage input of 24 to 110 VDC
ITS-6326-16P2T2XS-WV	Industrial L3 16-Port 10/100/1000T 802.3at PoE+ M12 + 2-Port 10GBASE-T M12 + 2-Port 10G Q-ODC Managed Ethernet Switch with dual wide voltage input of 24 to 110 VDC
ITS-6326-8P10T2XS-WV	Industrial L3 8-Port 10/100/1000T 802.3at PoE+ M12 + 8-Port 10/100/1000T M12 + 2-Port 10GBASE-T M12 + 2-Port 10G Q-ODC Managed Ethernet Switch with dual wide voltage input of 24 to 110 VDC

Accessories

CB-M12A5USB-100	5 Pin A-Coded M12 Female to USB Type-A Cable, 1 meters
CB-M12A5FF-120	5-Pin A-Coded M12 Female to bare end power or I/O cable, 1.2 meters
CB-M12X8MRJ-200	8-Pin X-Coded M12 Male to RJ45 Ethernet Cable, 2 meters
CB-M12X8M10G-200	8-Pin X-Coded M12 Male to RJ45 Ethernet Cat 6A (10G) Cable, 2 meters
CB-M23F5F-120	5-Pin M23 Female to bare end power cable, 1.2 meters
CB-QODC10G-600	Q-ODC 2 Plug/LC Single-Mode Fiber Cable, 6 meters

Related Products

ITS-6326-16P2TB-WV	Industrial L3 16-Port 10/100/1000T 802.3at PoE+ M12 + 2-Port 10GBASE-T M12 Bypass Managed Ethernet Switch with dual wide voltage input of 24 to 110 VDC
ITS-6326-16P2T-WV	Industrial L3 16-Port 10/100/1000T 802.3at PoE+ M12 + 2-Port 10GBASE-T M12 Managed Ethernet Switch with dual wide voltage input of 24 to 110 VDC
ITS-6326-16P-WV	Industrial L3 16-Port 10/100/1000T 802.3at PoE+ M12 Managed Ethernet Switch with dual wide voltage input of 24 to 110 VDC
ITS-6326-16P-LV	Industrial L3 16-Port 10/100/1000T 802.3at PoE+ M12 Managed Ethernet Switch with dual voltage input of 24 to 54 VDC
ITS-6326-8P8T-WV	Industrial L3 8-Port 10/100/1000T 802.3at PoE+ M12 + 8-Port 10/100/1000T M12 Managed Ethernet Switch with dual wide voltage input of 24 to 110 VDC
ITS-6326-8P8T-LV	Industrial L3 8-Port 10/100/1000T 802.3at PoE+ M12 + 8-Port 10/100/1000T M12 Managed Ethernet Switch with dual voltage input of 24 to 54 VDC
ITS-6326-18T2XS-WV	Industrial L3 16-Port 10/100/1000T M12 + 2-Port 10GBASE-T M12 + 2-Port 10G Q-ODC Managed Ethernet Switch with dual wide voltage input of 24 to 110 VDC
ITS-6326-16T-WV	Industrial L3 16-Port 10/100/1000T M12 Managed Ethernet Switch with dual wide voltage input of 24 to 110 VDC
ITS-6326-16T-LV	Industrial L3 16-Port 10/100/1000T M12 Managed Ethernet Switch with dual voltage input of 24 to 54 VDC

Available SFP+ Modules

10 Gigabit Ethernet Transceiver (10GBASE-SX/LX SFP+)

Model	Speed (Mbps)	Connector Interface	Fiber Mode	Distance	Wavelength	Operating Temp.
MTB-TSR2	10G	Dual LC/UPC	Single Mode	2km	1310nm	-40 ~ 85°C
MTB-TLR	10G	Dual LC/UPC	Single Mode	10km	1310nm	-40 ~ 85°C
MTB-TLR20	10G	Dual LC/UPC	Single Mode	20km	1310nm	-40 ~ 85°C
MTB-TLR40	10G	Dual LC/UPC	Single Mode	40km	1310nm	-40 ~ 85°C